



EMOS[®]

A brand of **legrand[®]**

Smart home that thinks for you

Connect your devices, set up automations
and control your home from anywhere
and at any time using a mobile app.



www.emosgosmart.eu

Making Life Easy

CONTENTS



EMOS GoSmart

- 03 Introducing EMOS GoSmart
- 07 Wi-Fi protocol
- 08 ZigBee protocol



02



HOME SECURITY

- 10 Indoor IP cameras
- 12 Outdoor IP cameras
- 16 Video door phones
- 19 Video doorbells
- 22 Wireless doorbells
- 23 Detectors and sensors
- 26 Access control systems

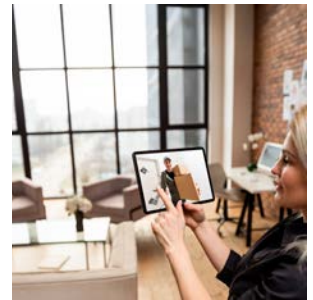

09

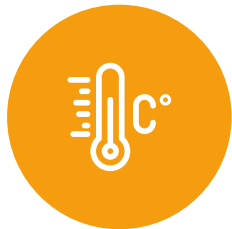

MEASUREMENT AND REGULATION

- 29 Thermostats
- 32 Weather stations
- 34 Air quality



28

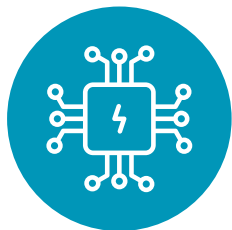

ELECTRICAL WIRING AND CONTROLS

- 36 Scene controllers
- 38 Central units
- 39 Extension cords
- 40 Sockets
- 41 Modules



35



LUMINAIRES AND LIGHT SOURCES

- 46 Light bulbs
- 47 Strips
- 49 Floodlights
- 50 Garden lighting
- 52 Ambient lighting

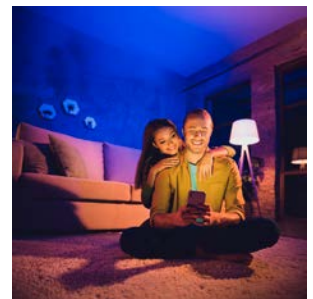

45



HOUSEHOLD AND GARDEN

- 59 Scales
- 60 For pets
- 62 Irrigation systems



58



EMOS GoSmart



EMOS GoSmart in your homes

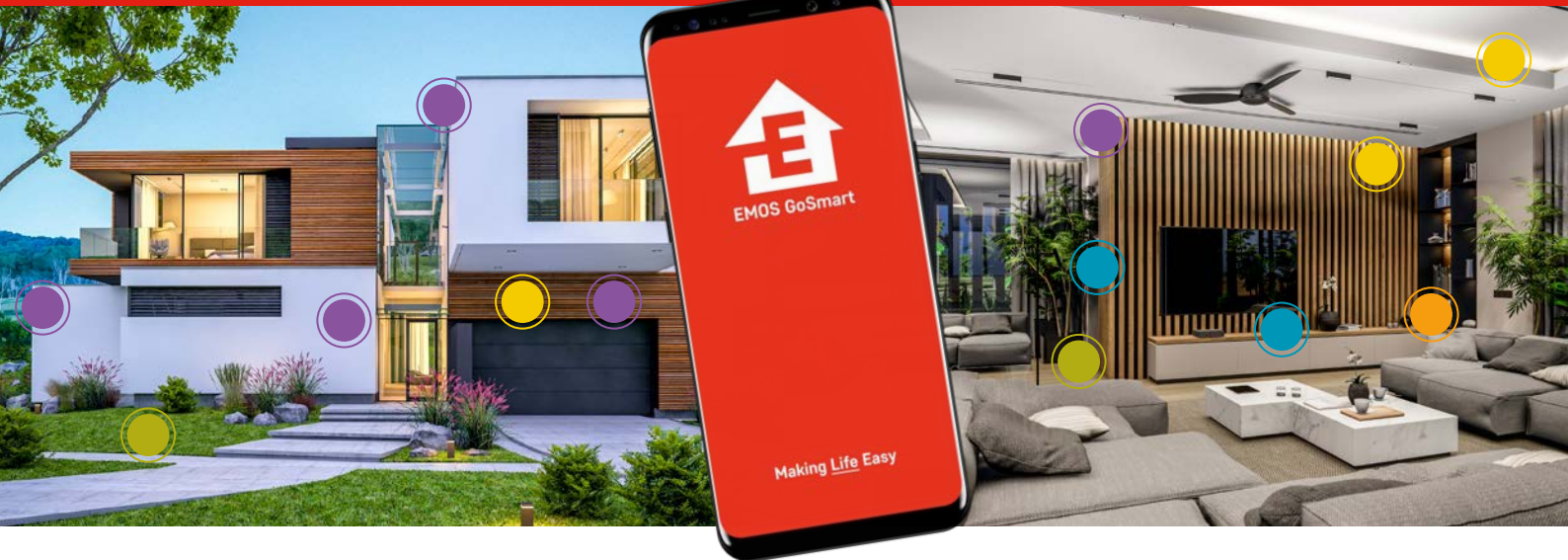

HOME SECURITY

- Indoor IP cameras
- Outdoor IP cameras
- Video door phones
- Video doorbells
- Wireless doorbells
- Sensors
- Access control systems



MEASUREMENT AND REGULATION

- Thermostats
- Weather stations
- Air quality

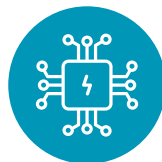

ELECTRICAL WIRING AND CONTROLS

- Scene controllers
- Central units
- Extension cords
- Sockets
- Modules



LUMINAIRES AND LIGHT SOURCES

- Light bulbs
- Strips
- Floodlights
- Garden lighting
- Ambient lighting



HOUSEHOLD AND GARDEN

- Scales
- For pets
- Irrigation systems

EMOS GoSmart Products

Optimal value for money

With the affordable prices and excellent quality of EMOS GoSmart products, smart home systems are now accessible to all. Through them you can easily create your smart home without the need for complicated renovations or equipment installation.



WIDE RANGE OF PRODUCTS

Dozens of EMOS GoSmart products are developed in collaboration with the world's leading manufacturers.



OPTIMAL PRICE AND QUALITY

EMOS GoSmart products undergo quality control by directly at the manufacturers' facilities and in our laboratory.



A SINGLE MOBILE APP

The EMOS GoSmart app allows you to control devices via your mobile device from anywhere.



TECHNICAL SUPPORT

We provide technical support and will help you get your EMOS GoSmart products up and running.



COMPATIBILITY AND EXPANDABILITY

Expand your smart home with EMOS GoSmart products and thousands of other TUYA-compatible products.

Modern Technologies

EMOS GoSmart products communicate via Wi-Fi, Bluetooth or the ZigBee communication protocol. You can also use voice control thanks to their compatibility with Amazon Alexa and Google Assistant.

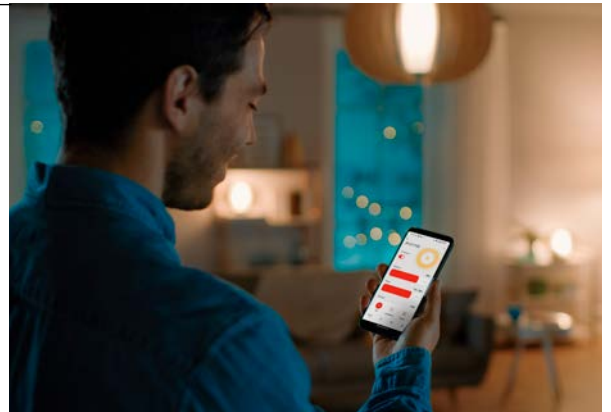
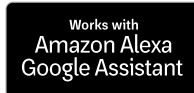

Data Security and Compatibility

Priorities of the EMOS GoSmart System

The EMOS GoSmart system is based on the TUYA global platform. This platform meets the highest security requirements and, by using encrypted communication, enables individual devices in a smart home to be interconnected, while ensuring their compatibility and ease of use.

Well-known brands that have chosen the TUYA platform for their smart devices include HAMA, LIDL, LEDVANCE, PHILIPS, and many more.

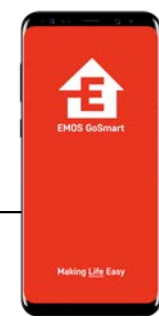

EMOS GoSmart App

Fully Localised and Easy to Use

The **EMOS GoSmart app** allows you to easily control all your smart home devices through your mobile phone or tablet with **Android or iOS** operating system. Thanks to flawless localisation, you'll be able to communicate with it in your native language.



Smart control for your household



Control multiple devices



Connect from wherever you want



Create and use smart scenarios



Share with your family in a single tap



Easy to control directly from your car



Without any complicated settings, the **EMOS GoSmart** app gives you an up-to-date overview of what is happening in your home and allows you to conveniently control all your smart devices remotely.



FULL LOCALISATION

Thanks to full localisation, you will be able to communicate with the app in your native language.



SIMPLE CONTROLS

No need to worry about complicated control of the app. It is so intuitive, anyone can use it.



SMART SCENARIOS

Let your products work together using smart scenarios.



DEVICE MANAGEMENT

You can control all smart home devices using the app from anywhere.



SMART NOTIFICATIONS

The app will alert you to what is happening in your home via notifications to your mobile phone.

Let your home take care of itself,
and treat yourself to more time for your loved ones and your interests.

Adapted for Tablets and Smartwatches

You can use our app not just on your mobile phone, but also on tablets and smartwatches. This means you can always control your smart home exactly the way you like – clearly displayed on a large tablet screen or instantly accessible right on your wrist. Whether you are at home, at work or on the move, the app offers you maximum convenience, flexibility and control over your smart devices, anytime and anywhere.



GPS-Triggered Automation

The app allows you to create automations based on GPS location. When you enter the set zone, the system can automatically open the gate or garage door, turn on the driveway lights, switch on the heating, or turn off the security camera. Conversely, when leaving the zone, the system can switch off the lights, activate the cameras and security sensors, or lower the temperature in the house.

We understand that this feature may raise concerns about privacy and potential 'tracking' among some users. It is therefore important to note that location data on both iOS and Android is handled exclusively through Apple's and Google's official mapping services, and no data is shared with third parties. What's more, the entire app runs on Microsoft and Amazon's official servers, and user data is stored in accordance with strict security protocols.



Dark Mode, Widgets, Guides and Manuals in the App

You can customise the app exactly to your liking. You can switch between a light and a dark theme, and have the ability to customise the entire home screen and use clear, easy-to-use widgets for quick access to key features without having to open the app. You can also find all product manuals directly in the app. This makes managing your smart home simple, convenient and always at hand.

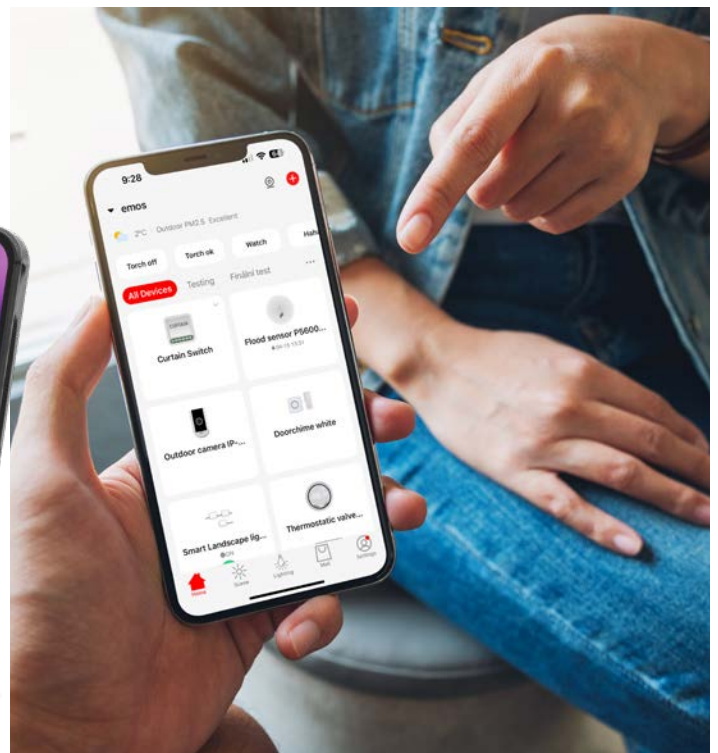

New AI Cloud Storage

Introducing the new AI Cloud feature, which takes the capabilities of EMOS GoSmart cameras to the next level. Cloud storage is no longer just about recording; it is about intelligently assessing situations to help you quickly understand what is really going on.

Human Detected

Camera has detected a person wearing a blue T-shirt and blue cap holding package



Fire Detected

A fire has broken out in front of the camera!



Pet Detected

A camera has detected a dog barking



AI Cloud automatically saves important events to secure online storage while analysing them using artificial intelligence. This allows it to identify relevant events and alert you only to what matters.

A major advantage is the ability to customise settings – users can choose which types of events they want to be notified about. The camera can therefore distinguish, for example, people, vehicles, pets, parcel deliveries or even specific situations, such as smoke or fire detection.

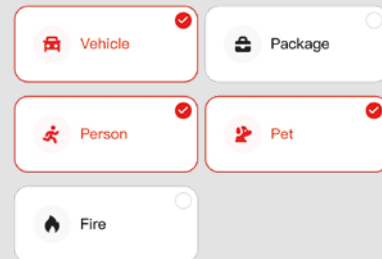

Unlike standard notifications, you will receive not only information about the movement, but also the context and a full record of the event. Everything is clearly laid out in the EMOS GoSmart app, where you can easily view and manage your records.

AI Cloud makes it easier to keep track of events, offers greater security and gives you greater peace of mind – exactly what you would expect from modern, smart security.

Improved Monitoring from a PC



Introducing the new AI Cloud feature, which takes the capabilities of EMOS GoSmart cameras to the next level. Cloud storage is no longer just about recording; it is about intelligently assessing situations to help you quickly understand what is really going on.

Aside from the EMOS GoSmart mobile app, you can also comfortably view your cameras via a web browser. IPC Terminal is the ideal solution for users who want to keep an eye on their camera feeds at all times, for example on their office or home computer.

Simply log into your account and you will immediately have access to all your connected devices. The interface is user-friendly and allows you to watch live feeds in real time without having to install any additional software.

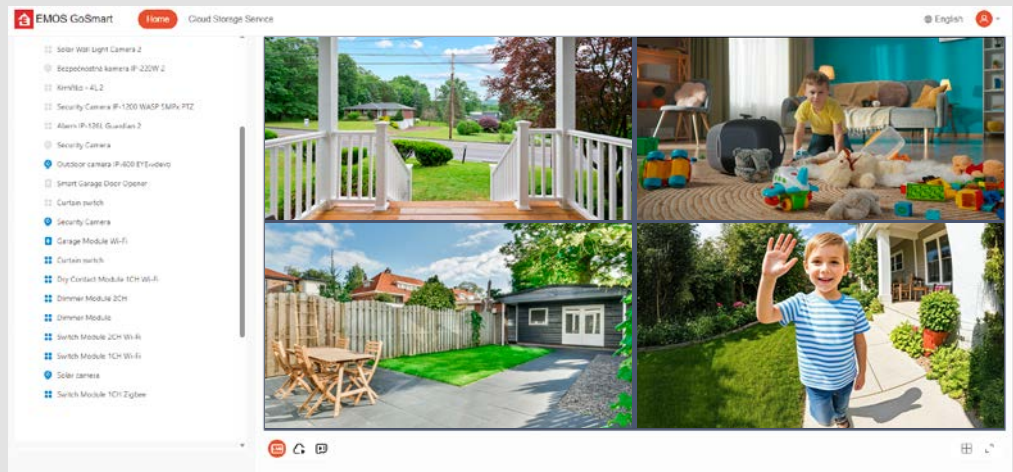

The web IPC Terminal also offers advanced features – you can control pan-tilt-zoom (PTZ) cameras, communicate via two-way audio, or capture recordings and still images directly from your browser. This means you have full control over your security even without your mobile phone. IPC Terminal thus expands the capabilities of the EMOS GoSmart system and offers flexible camera management customised specifically to your needs.



Wi-Fi Protocol

The Wi-Fi protocol connects to the internet via a router, which enables remote control and monitoring. It is the ideal protocol for smart devices that require high bandwidth, such as security cameras, video door phones and video doorbells.



Pros

- ability to transmit both video and audio
- easier installation and easy use
- lower purchase price
- no gateway is required; direct communication with the router
- compatible with most smart devices on the market

Cons

- higher energy consumption (demanding on small battery-powered devices)
- risk of signal interference from other electrical devices, nearby networks or physical obstacles, which may lead to signal range issues.
- if a large number of devices is connected, transfer speed may slow down

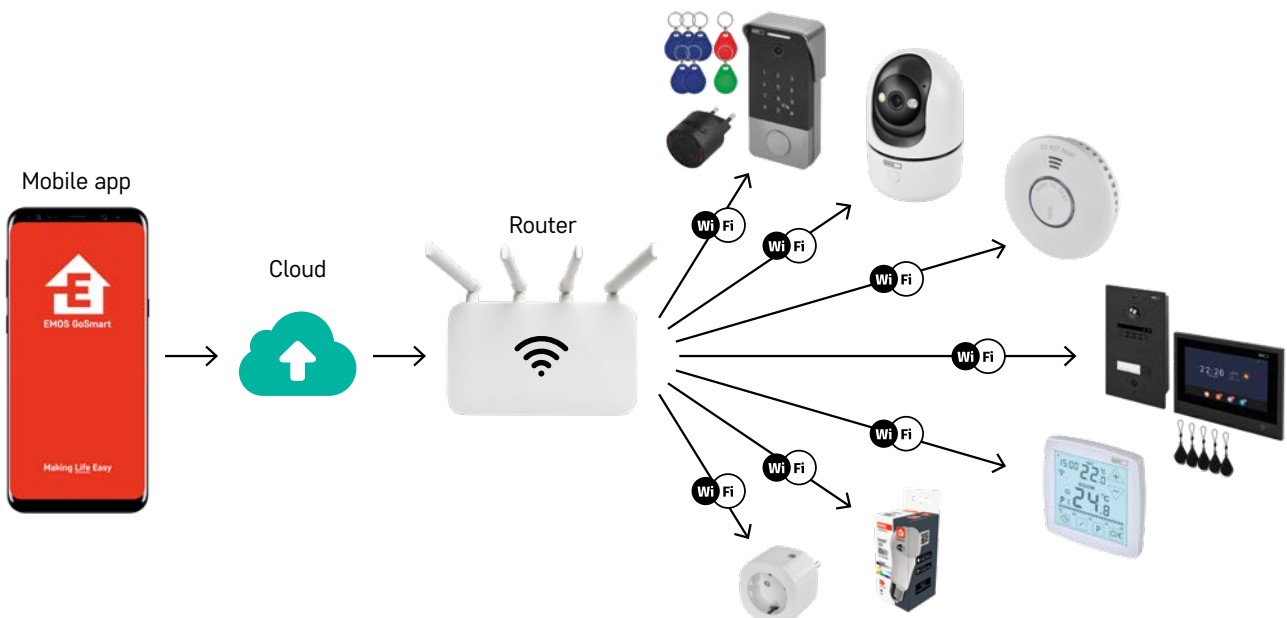

ZigBee protocol

A low-energy, short-range wireless communication protocol used primarily to connect sensors, detectors and other low-power smart home devices. The ZigBee protocol can support a large number of devices and can be interconnected via the network topology.



Pros

- low power consumption
- long battery life
- ability to communicate via a mesh network, i.e. the signal 'jumps' from one device to another, enabling communication over longer distances
- support for a large number of devices on the network
- open standard – compatibility with devices from different manufacturers

Cons

- higher purchase price
- need to purchase a ZigBee gateway (H5002)
- video and audio transmission is not possible

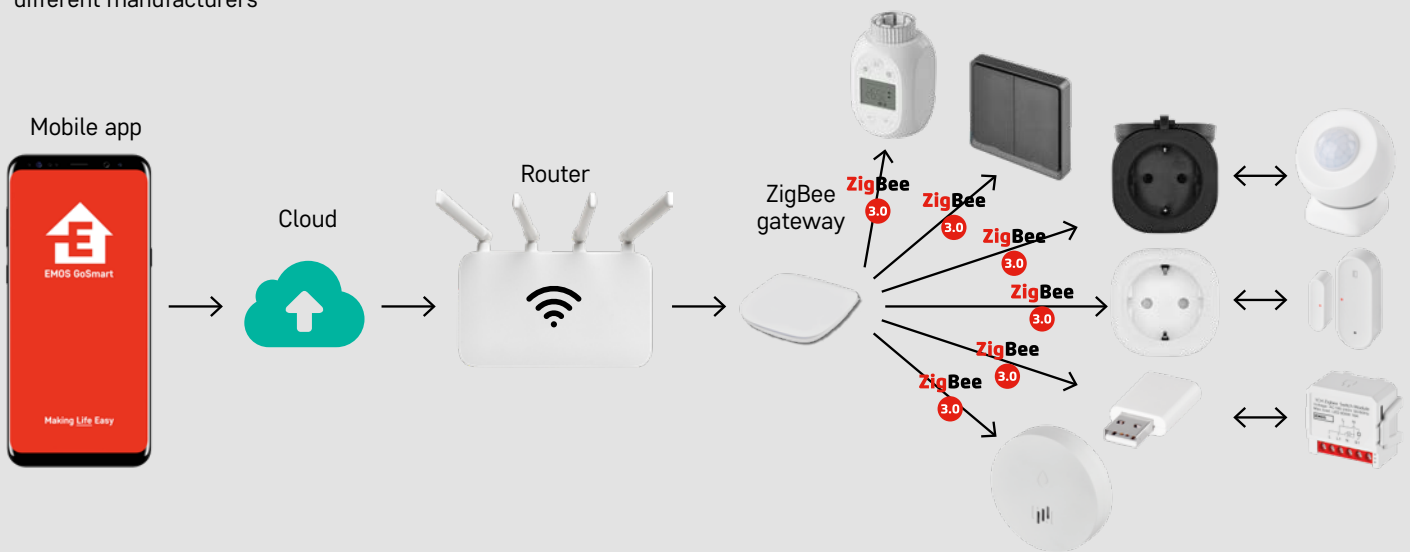



HOME SECURITY

- Indoor IP cameras
- Outdoor IP cameras
- Video door phones
- Video doorbells
- Wireless doorbells
- Sensors
- Access control systems



Improve the safety
of your home.



Indoor IP Cameras

Sleep easy knowing everything you love and care about is safe. Smart indoor cameras will watch over your baby, your rumbustious pet, or your house or apartment when you are away or on holiday. Ensure the security of your home and safety of your family with ease.



GoSmart Baby Monitor IP-500 GUARD

With this smart baby monitor, which streams high-quality video and audio to your mobile phone or the included LCD monitor, you will be up to date on every little rustle in your child's bedroom.

- wide-angle lens and two-axis camera rotation
- easy to use at home or when travelling thanks to an external 5" LCD monitor
- play lullabies and white noise, ambient lighting



- night vision
- enclosure: IP20
- motion and sound detection
- compatibility: EMOS GoSmart, TUYA, LIDL, Smartlife, open system
- voice communication: two-way
- protocol: Wi-Fi
- temperature and humidity monitoring



Order code
H4052
Order number
30 24 040 520





GoSmart Camera IP-220W / IP-220G

Pan-tilt indoor cameras in an elegant gunmetal and white. The cameras are equipped with advanced automatic and security features, including motion and sound detection. Powerful LEDs ensure high-quality illumination even in poor lighting conditions or in the dark. The ideal choice for a modern and secure home.

- call button directly on the camera
- WDR technology – balances extremely bright and dark areas in the frame to ensure high-quality footage
- a siren for even greater security
- pre-set monitoring points – use smart scenarios to teach the camera to monitor exactly the spot you need

- night vision
- enclosure: IP21
- motion detection
- sound detection
- compatibility: EMOS GoSmart, TUYA, LIDL, Smartlife, open system
- protocol: Wi-Fi
- voice communication: two-way



VIDEO TO WATCH

Order code
H4062
Order number
30 24 040 620



Order code
H4072
Order number
30 24 040 720





Outdoor IP Cameras

Whether you are going on a vacation or just going off to work, you can rest easy knowing your home stays safe. Smart cameras will watch over it for you. You will be immediately alerted to any suspicious activity around your home through the EMOS GoSmart mobile app.



GoSmart Camera IP-600 EYE

Get the perfect lighting for your chosen area and a clear view of what is happening there with this durable outdoor camera. Thanks to the unique combination of two devices, you can capture colour footage even in complete darkness.

- water-resistant body designed for the harshest weather conditions
- battery-powered, with charging via an integrated solar panel
- a siren and LEDs for an even better security system
- two-way voice communication

- night vision
- enclosure: IP44
- motion detection
- compatibility: EMOS GoSmart, TUYA, LIDL, Smartlife, open system
- protocol: Wi-Fi
- voice communication: two-way



Order code
H4056
Order number
30 24 040 560

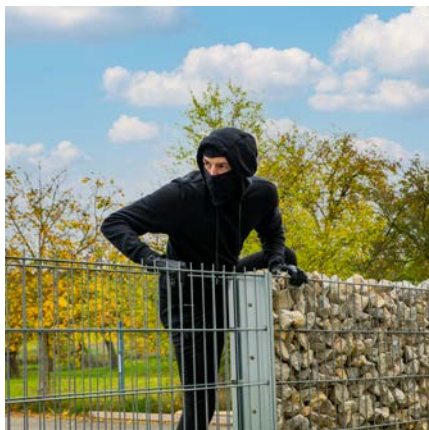



VIDEO TO WATCH

Order code
H4073
Order number
30 24 040 730



GoSmart Camera IP-1150 / IP-1150G SNAP

A versatile, durable camera suitable for both indoor and outdoor use. Thanks to its exceptionally long battery life and ease of installation, it will serve as a reliable guardian of your home while you are away.

- waterproof camera for indoor and outdoor security
- 5,200 mAh battery and charging via a solar panel
- advanced motion detection: the camera will describe what it sees via a notification in English.
- private zone – the option to set a zone that will be digitally blacked out and will not appear on the screen

- night vision
- enclosure: IP44
- motion detection
- sound detection
- compatibility: EMOS GoSmart, TUYA, LIDL, Smartlife, open system
- protocol: Wi-Fi
- voice communication: two-way

Order code
H4173
Order number
30 24 041 730



GoSmart Camera IP-1300 LANTERN

Combine security and lighting into a single smart solution. This modern and stylish camera, featuring a wide-angle pan-tilt-zoom lens, impresses not only with its design but, above all, with its security features. A major advantage is the ability to use any E27 bulb, so that you can choose the intensity and type of lighting yourself. This will not only give you an overview of what is happening around your house, garage or garden, but also provide you with ample light to suit your needs.

- 2-in-1 – security camera and stylish light with IP44 rating
- robust construction – glass, steel, anti-corrosion treatment
- siren
- permanently connected to a 230 V supply
- PTZ (pan, tilt, zoom) – camera rotation along a single axis (horizontally), manual tilt in 0–70° range and digital zoom
- motion and sound detection



- night vision
- enclosure: IP44
- motion detection
- compatibility: EMOS GoSmart, TUYA, LIDL, Smartlife, open system
- protocol: Wi-Fi
- voice communication: two-way

Order code
H4074
Order number
30 24 040 740



VIDEO TO WATCH





GoSmart Camera IP-1200 / IP-1200G WASP

The 5 MPx outdoor camera delivers outstanding image sharpness and captures photos and videos in exceptional detail. Thanks to this high resolution, you can make out important details such as faces, number plates and other key information to ensure the safety of the area around your property. Charging is provided by a solar panel and a 9,200 mAh battery.

- PTZ (pan, tilt, zoom) functionality, which ensures complete coverage of the monitored area
- siren for an even better security system
- colour recording even at night
- advanced motion detection: the camera will describe what it sees via a notification in English
- auto tracking – the camera zooms in on the moving object while displaying the full, unzoomed image in the corner of the screen

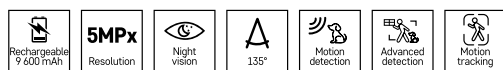

VIDEO TO WATCH

Order code
H4067
Order number
30 24 040 670



- night vision
- enclosure: IP44
- motion detection
- sound detection
- compatibility: EMOS GoSmart, TUYA, LIDL, Smartlife, open system
- protocol: Wi-Fi
- voice communication: two-way



Order code
H4167
Order number
30 24 041 670





GoSmart Camera IP-6100G HAWK

This outdoor camera with 4G/LTE connectivity offers a revolutionary combination of features that ensure security and flexibility in placement. Thanks to the mobile network connection, you can monitor the area in question wherever you do not have a Wi-Fi connection, such as a cottage in the woods, bee yards or remote properties.

- connection via 4G/LTE mobile network
- powered by a solar panel and a high-capacity 9,600 mAh battery
- 4MPx camera resolution for high-quality images and reasonable data usage
- PTZ (pan, tilt and zoom) – pan and zoom the camera as needed and monitor a much larger area than you could with a camera trap
- built-in spotlight for additional illumination in poor lighting conditions



Order code
H4168
Order number
30 24 041 680



GoSmart Camera IP-1100G WALL

This sleek wall-mounted smart camera is the ideal solution for modern home security. Thanks to its built-in solar panel and powerful battery, it offers long-lasting wireless operation without the need for frequent recharging. It combines high-resolution image with practical illumination, making it a smart 2-in-1 device that provides both surveillance and safe lighting.

- charging via a 5,200 mAh battery and an integrated 1.5 W solar panel
- 2K UHD resolution for a sharp and detailed image day and night
- 2-in-1 camera + 350 lm light for illuminating the space
- easy installation
- IP44 weatherproofing
- a stylish look for modern homes

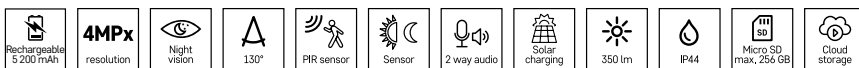

Order code
H4170
Order number
30 24 041 700





Video Door Phones

Gain perfect control over access to your home. Video door phones will let you communicate with invited and uninvited guests at your door safely and without the need to open the door, whether you are home or away.



GoSmart Video Door Phone IP-750A

An elegant video door phone with a touchscreen display that ensures constant monitoring of your home. In addition to its security features, it allows you to conveniently unlock your front door and open your garage door or gate.

- stylish 7" LCD monitor with an IPS touchscreen
- advanced features for securing the area in front of the entrance to the building
- a scalable system suitable for blocks of flats and multiple households
- 3 modes: at home, do not disturb, and away from home



- automatic photo storage
- lock control
- option to connect additional cameras
- monitor dimensions: 175 × 118 × 25 mm
- camera unit dimensions: 142 × 44 × 21 mm
- maximum camera angle of view: 160°

Order code
H4020
Order number
30 10 040 200



8 592920 129678



GoSmart LCD Monitor IP-750B

An additional 7" LCD monitor for the GoSmart series of video door phones offers true-to-life colour reproduction and wide viewing angles. When combined with an outdoor camera unit, it ensures complete surveillance of the area outside your front door.

- stylish 7" LCD monitor with an IPS touchscreen
- advanced features for securing the area in front of the entrance to the building
- a scalable system suitable for blocks of flats and multiple households
- used to expand the IP750A kit; does not function on its own

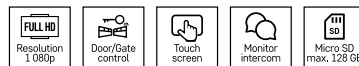

- screen size: 7"
- lock control
- colour display: yes, IPS
- intercom
- number of connecting wires (monitor/lock/gate): 4+0+2
- option to connect additional cameras
- recommended camera unit: H3016, H3017, H3018, H3019
- monitor dimensions: 175 × 118 × 25 mm

Order code
H4021
Order number
30 10 040 210



8 592920 129692





GoSmart Video Door Phone IP-880A

A stylish video door phone with a touchscreen display to keep an eye on your home. In addition to its security features, it offers new IP technology for even better image and sound transmission.

- stylish 7" monitor with an IPS touchscreen
- durable, all-metal outdoor unit with two mounting boxes for surface-mounted or flush installation
- simple connection – 2-wire IP Plug & Play
- advanced features for securing the area in front of the entrance to the building
- unlocking via fingerprint or RFID chips (5 per pack)
- expandable with additional outdoor and indoor units (H4081, H4082, H4083, H4084)

- automatic photo storage
- lock control
- option to connect additional cameras
- monitor dimensions: 152 × 205 × 22 mm
- camera unit dimensions: 125 × 235 × 35 mm
- maximum camera angle of view: 170°

Order code
H4080
Order number
30 10 040 800



GoSmart Extra Monitor IP-880B

An extra 7" monitor for the GoSmart series of video door phones, offering faithful colour reproduction, a touchscreen and new IP technology for even better image and sound transmission. Add an outdoor camera unit to create a modern home security system.

- stylish 7" monitor with an IPS touchscreen and LED RGB illumination
- simple connection – 2-wire IP Plug & Play
- Lock / gate control
- expandable system – the monitor can be added to the H4080 video door phone kit, or used on its own with the H4082, H4083 and H4084 outdoor units

- screen size: 7"
- colour display: yes, IPS
- lock control: door lock, gate travel
- intercom
- number of connecting wires (monitor/lock/gate): 2
- option to connect additional cameras
- recommended camera unit: H4082, H4083, H4084
- monitor dimensions: 152 × 205 × 22 mm
- pack: 1 pc, box

Order code
H4081
Order number
30 10 040 810



GoSmart IP Outdoor Unit

- 1/2/3 Buttons

Camera units for the GoSmart series of video door phones, featuring an integrated RFID reader, sharp, high-quality image day and night and a wide-angle lens. The metal body is resistant to both mechanical damage and bad weather.

- the pack contains 5 RFID chips and the unit includes a fingerprint reader
- camera unit with one, two or three buttons
- camera angle of view 170°
- 2 MPx camera for a constant view of what is happening outside the front door
- expandable system – the unit can be added to the H4080 video door phone kit or used on its own with the H4081 monitor
- number of buttons on the camera unit: 1,2,3
- anti-vandal design of the camera unit
- power supply: 24 V DC (BUS)
- camera illumination: yes, 5 m
- camera unit dimensions: 125 × 235 × 35 mm
- enclosure: IP44
- camera field of view: 170°
- mounting: surface-/flush-mounted

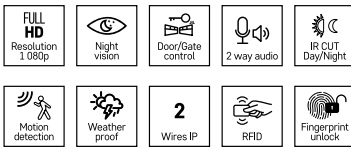

Order code
H4082
Order number
30 10 040 820



Order code
H4083
Order number
30 10 040 830



Order code
H4084
Order number
30 10 040 840





Video Doorbells

Want to have a clear idea of what is happening at your door at all times? Smart video doorbells make it easy, whether you are home or away. Communicate remotely with visitors, capture video footage and receive notifications about any movement detected.

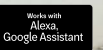

GoSmart Video Doorbell IP-09D

This video doorbell, featuring motion detection, two-way communication and night vision, will keep your home secure day and night. The included LCD solar panel allows it to be used even in places where it would otherwise be impossible due to the lack of power cables.

- solar panel and battery-powered operation for locations without cable connections
- full HD camera for a constant view of what is happening outside the front door
- allows control of the door lock from a mobile app
- theft alarm

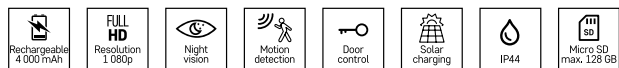

- lock control
- camera unit enclosure: IP44
- motion detection
- IR CUT
- compatibility: EMOS GoSmart, TUYA, LIDL, Smartlife, open system
- protocol: Wi-Fi
- voice communication: two-way

Order code

H4030

Order number
30 10 040 300



8 592920 11754 5





GoSmart Video Doorbell IP-09C

This video doorbell, featuring motion detection, two-way communication and night vision, will keep your home secure day and night. You can use the existing cables to install the outdoor doorbell button once you have removed the previous doorbell.

- easy installation using existing cabling
- full HD camera to monitor what is happening outside the front door
- allows control of the door lock from a mobile app
- charging adapter included

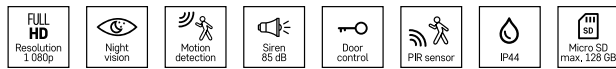

- lock control
- camera unit enclosure: IP44
- motion detection
- IR CUT
- compatibility: EMOS GoSmart, TUYA, LIDL, Smartlife, open system
- protocol: Wi-Fi
- voice communication: two-way

Order code
H4031
Order number
30 10 040 310



GoSmart Video Doorbell IP-15S

This video doorbell, featuring motion detection, two-way communication and night vision, will keep your home secure day and night. Its wide range of power supply options makes it a versatile solution for installation in your home.

- battery and mains power
- full HD camera to monitor what is happening outside the front door
- stylish design



- camera unit enclosure: IP65
- motion detection
- IR CUT
- compatibility: EMOS GoSmart, TUYA, LIDL, Smartlife, open system
- protocol: Wi-Fi
- voice communication: two-way

Order code
H4032
Order number
30 10 040 320

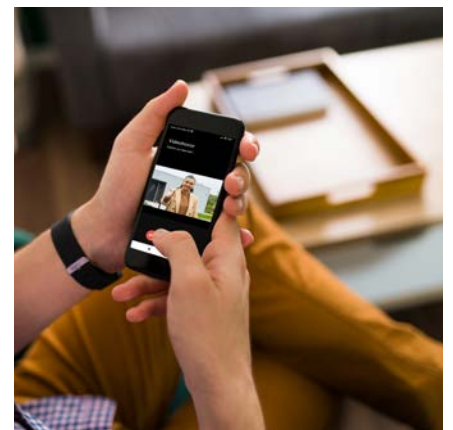



BENEFITS OF

- ▶ **powering of various devices** – IP cameras, wireless access points (WAPs) or VoIP phones
- ▶ **time-saving** – just one cable for both data and power transmission
- ▶ **flexibility** – option for placement further away from sockets
- ▶ **overload protection**
- ▶ **UPS reliability** – power is uninterrupted even during a power cut



VIDEO TO WATCH

GoSmart Video Doorbell IP-20PoE

An innovative and durable video doorbell for remote unlocking via a mobile app or NFC key fob, giving you maximum control over access to your home. The main benefit is Power over Ethernet (PoE), which enables both data and power to be transmitted via a single cable.

- option to open doors even during a call
- full HD camera with night vision
- two-way communication
- can be connected via cable over a distance of up to 100 m

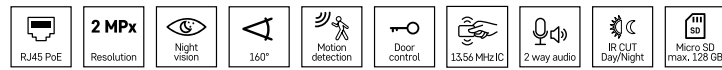

- number of buttons on the camera unit: 1
- anti-vandal design of the camera unit
- power supply: 12 V DC (included)
- camera illumination: 10 m
- camera unit dimensions: 50 × 139 × 38 mm
- enclosure: IP44
- camera field of view: 160°
- mounting: surface



Order code
H4033
Order number
30 10 040 330



GoSmart Video Doorbell IP-21PoE Keypad

This innovative and durable video doorbell with a backlit keypad alerts you to visitors and ensures security even at night thanks to its high-quality night-vision camera. The main benefit is Power over Ethernet (PoE), which enables both data and power to be transmitted via a single cable.

- 3 unlocking options: NFC key fob, mobile app and password (PIN)
- indoor gong included
- ringtone notifications via a mobile app
- creation of smart scenes
- backlit keypad for comfortable use in low light or in the dark

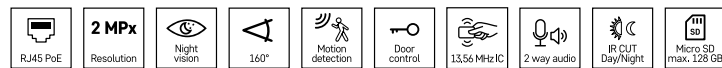

- number of buttons on the camera unit: 1
- anti-vandal design of the camera unit
- power supply: 12 V DC (included)
- camera illumination: 10 m
- camera unit dimensions: 69 × 38 × 140 mm
- enclosure: IP44
- camera field of view: 160°
- mounting: surface



Order code
H4034
Order number
30 10 040 340

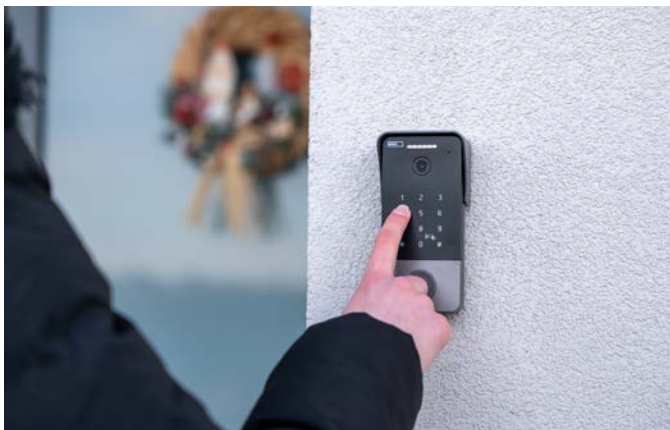



Wireless Doorbells

Never miss an important visitor or parcel delivery again. Smart wireless doorbells offer a range of features to make your life easier. From instant notifications to your phone, to easy control and configuration via a mobile app, to integrating with other smart devices in your household.

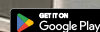
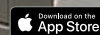

GoSmart Wireless Doorbell P5735WS / P5735SS

A wireless doorbell that lets you know every time the doorbell rings via notifications on your mobile phone. Thanks to automatic pairing and convenient control via the app, it is easy and intuitive to use.

- easy setup and control of the doorbell via a mobile app
- expansion to include 2 external buttons for flexible placement
- modern design in white and metallic colour
- creation of smart scenarios and the option for automations with other smart devices

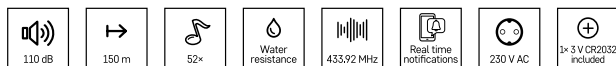

- button range: 150 m
- number of ringtones: 52
- special functions: set different ringtones and volume levels for each button paired in the app
- optical signalisation on the chime
- optical signalisation on the button
- maximum ringtone volume: 110 dB
- volume control: 4 levels



VIDEO TO WATCH

Order code
P5735WS
Order number
34 02 127 000



8 592920 135433



Order code
P5735SS
Order number
34 02 128 000



8 592920 135488





Detectors and Sensors

Detect gas and water leaks, the early stages of a fire or any movement or unusual activity in real time thanks to smart sensors and detectors that will immediately send notifications to your mobile device via the EMOS GoSmart app. Quick response can prevent significant damage to your property.



ZigBee 3.0



GoSmart Door Sensor IP-2111Z ZigBee

The smart door sensor is an innovative device designed to ensure your safety and comfort in everyday life. No need to worry any more whether you have really closed the windows and doors in your home.

- option to integrate with home automation systems, e.g. turning on the lights when entering a room
- ability to generate statistics on the opening and closing of the monitored object
- identification of unusual situations
- tamper switch on the back of the sensor, which sends an alert in the event of the sensor being removed or tampered with

- enclosure: IP20
- power supply: 1× CR2032 (3 V) not included

ZigBee
3.0

Order code
H5025
Order number
30 69 052 050



VIDEO TO WATCH

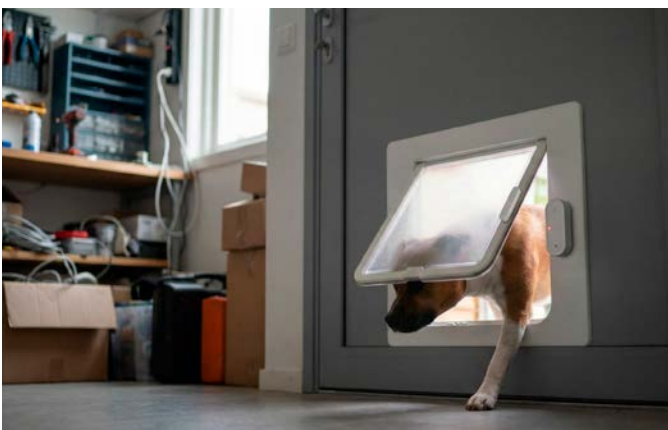
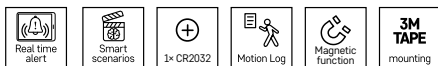

GoSmart Motion Sensor IP-2310Z ZigBee

Step into a safer and more energy-efficient future with our compact and versatile smart motion sensor. Thanks to instant motion detection, motion logs and automation options, you will never again miss a thing.

- instant alerts and notifications in the mobile app
- precise motion detection at a distance of up to 8 metres and within a 60° angle
- device activation based on motion or a schedule

- detection range: 8 m
- detection angle: 60°
- enclosure: IP20
- power supply: 1× CR123A (3 V) not included



VIDEO TO WATCH

ZigBee

3.0



Order code

H5024

Order number
30 69 052 040



8 592920 156490





GoSmart Smoke Detector TS380C-HW

With a smart smoke detector, you can spot potential hazards in time, wherever you are. If the detector detects smoke, it will emit loud warning sounds and visual alerts, and will also immediately send a notification to your mobile phone.

- minimalist design
- loud 85 dB audio alarm within a range of 3 metres
- alerts when the device is nearing the end of its life or when the batteries need replacing
- can be integrated into a home security system



- indication type: visual and audio
- alarm volume: >85 dB at a distance of 3 m
- service life: 10 years
- enclosure: IP20
- power supply: 2x 1.5 V AA, included



Order code
P56500S
Order number
21 04 103 000



GoSmart Water Leak Detector P56000S ZigBee

With a smart water leak detector, you can spot potential hazards in time, wherever you are. If the detector detects leaking water, it will emit loud warning sounds and visual alerts, and will also immediately send a notification to your mobile phone.

- alarm volume of 85 dB
- compact size and elegant design
- ideal for bathrooms, kitchens or utility rooms
- can be integrated into a home security system



- indication type: visual and audio
- alarm volume: >85 dB at a distance of 1 m
- service life: 10 years
- enclosure: IP65
- power supply: 1x 3 V CR2, included



Order code
P56000S
Order number
21 04 104 000



GoSmart Carbon Monoxide Detector TCS0101W

The ideal assistant for those who heat their homes with a gas boiler, a wood-burning stove, or use a gas water heater or gas cooker. Also suitable for any room containing equipment that burns fossil fuels (wood, coal, petrol, gas, etc.)

- provides real-time updates on CO levels in your home
- optical and audio signalisation
- alarm log
- flexibility of placement – hung/self-standing
- option to test functionality using the TEST/HUSH button



- indication type: visual and audio
- alarm volume: >85 dB at a distance of 3 m
- service life: 10 years
- enclosure: IP30
- power supply: 2x 1.5 V AA, included



Order code
P56400S
Order number
21 04 105 000





Access Control Systems

These systems provide efficient and secure management of your premises. They allow you to easily control access to your building and monitor movement of persons, and inform you of who enters and leaves the area, be it for work or leisure. Everything can then be easily controlled via the EMOS GoSmart app on your mobile device.



GoSmart Keypad IP-006AX

This sophisticated keypad, featuring a range of smart functions such as remote unlocking via the EMOS GoSmart app, simplified management of individual members directly within the app, access logs and more, will become a reliable security assistant at your front door.

- high-quality and durable keypad finish
- remote unlocking via the EMOS GoSmart app
- access tracking feature for easy attendance management
- management of individual members (each member can have their own unique code or RFID chip)



- number of switching relays: 1
- number of codes: up to 1,000
- power supply: 12 V AC/DC (not included)
- backlighting
- dimensions: 36 × 76 × 190 mm



Order code
H5023
Order number
30 69 050 230



GoSmart Alarm IP-126L GUARDIAN with Motion Sensor

A smart home alarm system that combines state-of-the-art technology with simple operation. The system includes a 125 dB alarm siren with a motion detector which ensures that no uninvited guest goes unnoticed, 6 door and window sensors to provide comprehensive protection for all entry points to your home, and 2 remotes for easy and convenient operation of the entire system.

- easy installation and control via a mobile app
- notifications about alarm activation
- motion detection
- SOS button on the remote to trigger the alarm and call for immediate assistance
- 2 modes: a loud siren and gong (ideal for use in shops, doctors' offices and anywhere else where you need to announce an arrival)



- detection range: 8 m
- detection angle: 110°
- activation time: 5 s, 30 s, 1 min, 3 min, 5 min, 8 min
- enclosure: IP21
- power supply: DC USB 5 V / 3× AA

Order code
H5030
Order number
30 69 050 300



VIDEO TO WATCH

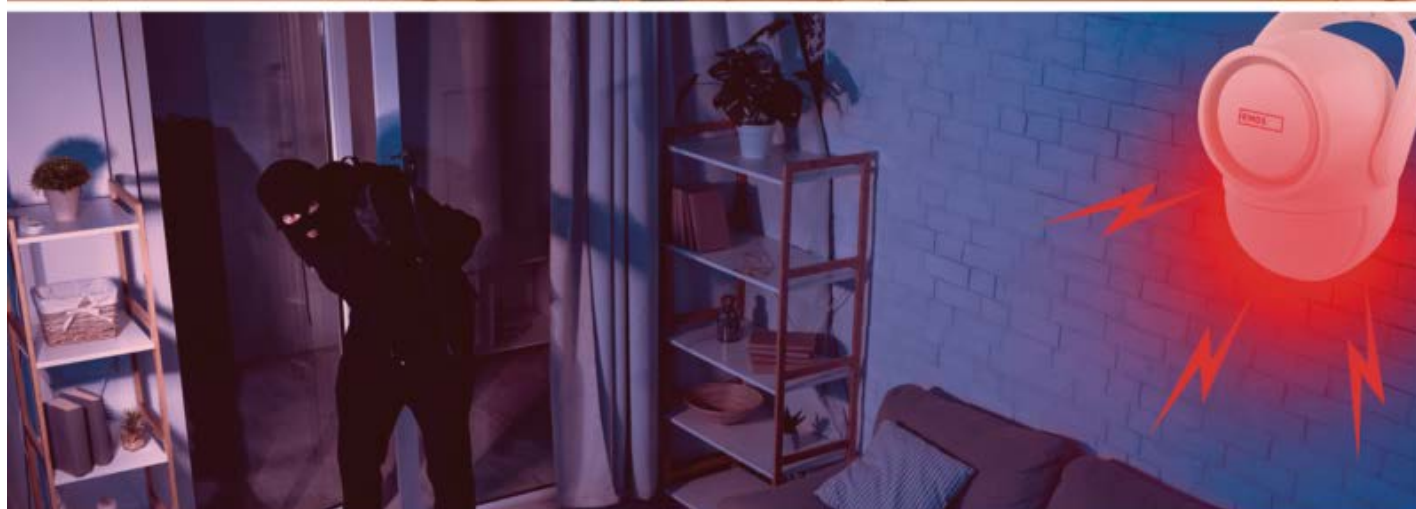

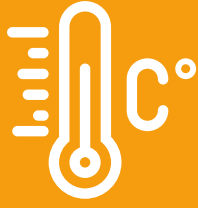

MEASUREMENT AND REGULATION

- Thermostats
- Weather stations
- Air quality



Improve the comfort
of your living.



Thermostats

Reduce expenses on heating your home thanks to smart thermostats and thermostatic valve heads. Use them to set the ideal temperature for different rooms and times of day and control them remotely using your mobile device.



GoSmart Thermostat P56201

- temperature calibration
- child lock
- operating modes: automatic / manual / temporary / boost / holiday
- control type: programmable electronic room thermostat, option to control via mobile phone (iOS, Android)
- regulation type: heating and cooling system
- type of temperature setting: 6 temperature changes per day
- temperature setting: 5 °C to 35 °C, in 0.5 °C increments
- switching: voltage-based 230 V AC, 50 Hz
- dimensions: 138 × 88 × 33 mm

Order code
P56201
Order number
21 01 900 000

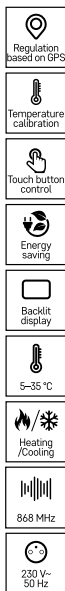

GoSmart Wireless Thermostat P56211

- temperature calibration
- child lock
- operating modes: automatic / manual / temporary / boost / holiday
- control type: programmable electronic room thermostat, option to control via mobile phone (iOS, Android)
- regulation type: heating and cooling system
- type of temperature setting: 6 temperature changes per day
- temperature setting: 5 °C to 35 °C, in 0.5 °C increments
- switching: 230 V AC or voltage-free
- receiver dimensions: 37 × 86 × 86 mm
- transmitter dimensions: 40 × 138 × 96 mm

Order code
P56211
Order number
21 01 900 001

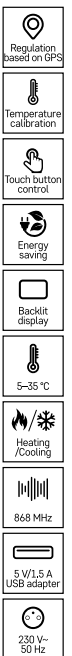

GoSmart Wireless Thermostat P56S11

- ability to control up to 10 switching units with a single thermostat
- smart thermostat with support for both OpenTherm and conventional control systems
- indication of the current and set temperatures on a chart
- heating control based on GPS location within the app
- large illuminated touchscreen
- eco-friendly packaging

- control type: programmable electronic room thermostat, option to control via mobile phone (iOS, Android)
- regulation type: heating and cooling system
- type of temperature setting: comfort and energy-saving
- temperature setting: 7 °C to 30 °C, in 0.2 °C increments
- switching: 230 V AC or voltage-free



Order code
P56S11
Order number
21 01 310 000



8 592920 149133



VIDEO TO WATCH

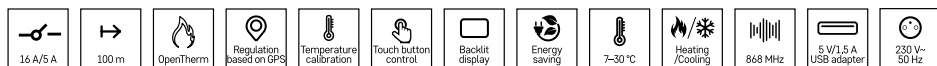

GoSmart Thermostat P56S01

- smart thermostat with support for both OpenTherm and conventional control systems
- indication of the current and set temperatures on a chart
- floor sensor included – suitable for underfloor heating
- large illuminated touchscreen

- control type: programmable electronic room thermostat, option to control via mobile phone (iOS, Android)
- regulation type: heating and cooling system
- type of temperature setting: comfort and energy-saving
- temperature setting: 7 °C to 30 °C, in 0.2 °C increments
- switching: 230 V AC
- dimensions: 98 × 37 × 98 mm



Order code
P56S01
Order number
21 01 213 000



8 592920 149140



GoSmart Floor Thermostat P56S01F

- smart thermostat with support for both OpenTherm and conventional control systems
- suitable for installation in a junction box – flush mounting
- indication of the current and set temperatures on a chart
- floor sensor included – suitable for underfloor heating

- control type: programmable electronic room thermostat, option to control via mobile phone (iOS, Android)
- regulation type: heating and cooling system
- type of temperature setting: comfort and energy-saving
- temperature setting: 7 °C to 30 °C, in 0.2 °C increments
- switching: 230 V AC
- dimensions: 98 × 37 × 98 mm

Order code
P56S01F
Order number
21 01 212 000



8 592920 149157



GoSmart Digital Thermostatic Valve Head P5631S ZigBee 3.0

- freeze protection
- open window detection
- indication of the current and set temperatures on a chart
- thermostatic valve head type: SMART, programmable
- type of temperature setting: 6 temperature changes per day
- temperature setting: 5 °C to 30 °C, in 0.5 °C increments
- freeze protection
- open window function

Order code
P5631S
Order number
21 01 900 017



ZigBee
3.0

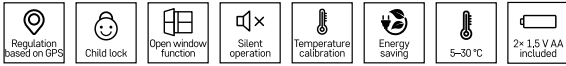

GoSmart Floor Thermostat P56201UF / P56201BUF

- temperature calibration
- child lock
- operating modes: automatic / standby / temporary manual / holiday
- control type: programmable electronic room thermostat, option to control via mobile phone (iOS, Android)
- regulation type: heating system
- type of temperature setting: 6 temperature changes per day
- temperature setting: 1 °C to 70 °C, in 0.5 °C increments
- switching: voltage-based 230 V AC, 50 Hz
- dimensions: 86 × 86 × 43 mm



Wi Fi

Order code
P56201UF
Order number
21 01 900 002



Wi Fi

Order code
P56201BUF
Order number
21 01 900 012

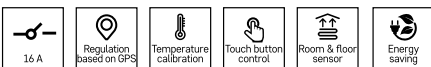

GoSmart 2-in-1 socket thermostat with digital timer function, schuko, WiFi

A smart, multifunctional thermostatic and timer socket that you can use as a handy thermostat during the heating season or as a timer socket for appliances, instantly turning them into smart devices that allow you to monitor their energy consumption via a mobile app.

- 2-in-1 thermostat and timer socket
- user-friendly illuminated display
- control via mobile app or manually
- energy meter
- programme memory in the event of a power cut
- creation of smart scenes and automations



- type of control: programmable electronic room thermostat, option to control via mobile phone (iOS, Android)
- control mode: heating and cooling system
- temperature adjustment type: 6 temperature changes per day
- temperature adjustment: 5 °C to 40 °C, resolution 0.5 °C
- adjustable variance of temperature: from 0.2 °C up to 2 °C, after 0.1 °C
- maximum load: 3 680 W

Order code
P56601SH
Order number
21 06 000 400



Wi Fi



VIDEO TO WATCH



Weather Stations

Modern weather stations track indoor and outdoor temperature, humidity, air pressure and other important meteorological data, which they then clearly display on a screen or in a mobile app. The range also includes PROFI weather stations with an anemometer, which, in addition to basic data, also measure wind speed and direction, thereby providing an even more accurate picture of current conditions. Thanks to the integration with the EMOS GoSmart app, you can track weather trends, save measurement history and have all the important information at your fingertips – whether you are at home or away.



GoSmart Wireless Weather Station E8610

This smart weather station provides a comprehensive overview of the weather, and many other features to make your life easier. You can control it using the EMOS GoSmart app on your mobile device, allowing you to automate interactions with other smart devices in your home. The modern design, featuring a permanently illuminated LED screen, allows it to be placed on a horizontal surface or hung on the wall.

- measurement of indoor and outdoor temperature and humidity
- 5-day weather forecast
- you can view your measurement history in the mobile app with clear graphs and export measured data to Excel
- supports up to 3 output sensors (80 m range)
- can be paired with the E00032 pool thermometer
- other features: clock, date, calendar, temperature warnings, UV index, sunlight intensity, alarm clock, 4 temperature alerts and much more

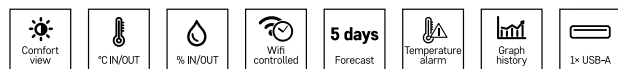

- clock: Wi-Fi-controlled
- outdoor temperature: -40 °C to +70 °C, 0.1 °C resolution
- indoor temperature: -10 °C to +50 °C, 0.1 °C resolution
- outdoor humidity: 20 % to 95 % RH, increments of 1 %
- indoor humidity: 20 % to 95 % RH, increments of 1 %
- min. and max. temperature



VIDEO TO WATCH

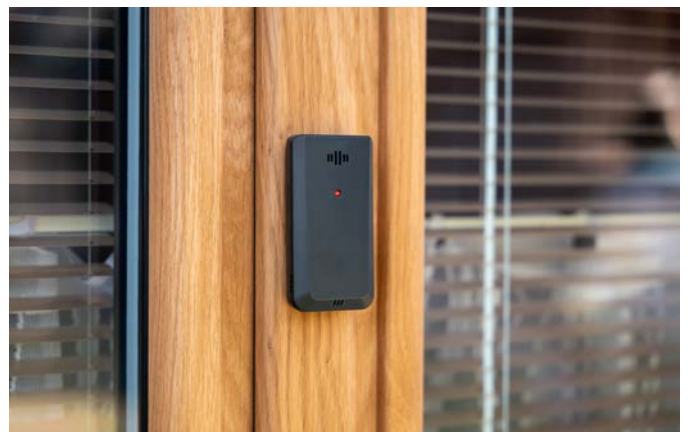

Order code
E8610
Order number
26 06 183 000



These smart weather stations with an anemometer provide accurate weather measurements and reliable monitoring of conditions around the house. They combine outdoor temperature and humidity sensors with an anemometer for measuring wind speed and a rain gauge, with all data transmitted wirelessly over a distance of up to 100 metres. By linking to the mobile app, you gain an instant overview of the current weather, historical data and notifications about significant changes.

GoSmart Wireless PROFI Weather Station E6000

- all measured values and forecasts available via the mobile app
- accurate real-time weather measurements
- measurement of wind speed and rainfall (rain gauge)
- wireless data transmission from up to 3 outdoor sensors over a distance of 100 metres (E06000)
- in-app weather forecasts and alerts, notifications about changes in temperature, humidity, etc.

- clock: Wi-Fi-controlled
- outdoor temperature: -40 °C to +70 °C, 0.1 °C resolution
- outdoor humidity: 1 % to 99 % RH, 1 % resolution

Order code
E6000
Order number
26 06 188 000



Order code
E6001
Order number
26 06 187 000



GoSmart Wireless PROFI Weather Station E6001

- weather station with an indoor monitor for displaying key information
- measured data is displayed both in the app and on the weather station's screen
- accurate real-time weather measurements
- measurement of wind speed and rainfall (rain gauge)
- wireless data transmission from the anemometer over a distance of up to 100 metres
- in-app weather forecasts and alerts, notifications about changes in temperature, etc.

- clock: Wi-Fi-controlled
- outdoor temperature: -40 °C to +70 °C, 0.1 °C resolution
- indoor temperature: -10 °C to +50 °C, 0.1 °C resolution
- outdoor humidity: 1 % to 99 % RH, 1 % resolution
- indoor humidity: 1 % to 99 % RH, 1 % resolution
- min. and max. temperature

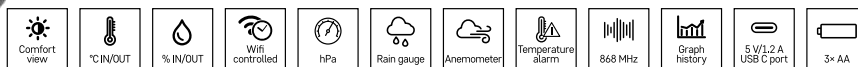



Air Quality

Enter a world of cleaner and healthier living with us. Track and analyse the current air quality in your home with products from the EMOS GoSmart series.



GoSmart Air Quality Monitor E30300

Elevated CO₂ levels can cause drowsiness, fatigue and a reduced ability to concentrate, as well as headaches and an unpleasant sensation from the stale air. The GoSmart air quality monitor is the ideal tool for ensuring a comfortable and healthy environment wherever you need. Suitable for offices, classrooms, conference rooms, studies, etc.

- tracking of current CO₂ levels
- If the set CO₂ level is exceeded, an internal alarm is triggered and a notification is sent via the EMOS GoSmart app to your mobile phone
- colour-coded air quality animations using a 3-tier system
- also displays the time and can be used as an alarm clock
- user-friendly, permanently illuminated display



- permanent illumination
- CO₂ warning
- CO₂ level indicator
- indoor temperature: 0 °C to +50 °C, 0.1 °C resolution
- indoor humidity: 20 % to 90 % RH, 1 % resolution
- protocol: Wi-Fi

Order code
E30300
Order number
26 27 303 000



- CO₂ detection
- CO₂ alert
- °C IN
- % IN
- Clock & alarm clock
- Data storage
- Backlit display



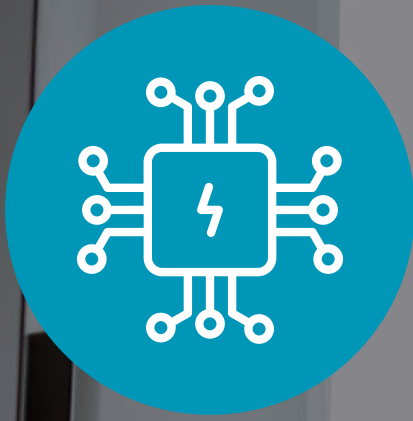

ELECTRICAL WIRING AND CONTROLS

- Scene controllers
- Central units
- Extension cords
- Sockets
- Modules



Control your appliances
comfortably
and with ease.



Scene Controllers

Control multiple household electrical devices and lights at the same time with a single button. With this sophisticated type of switch, you can programme various scenes or light effect settings and then simply activate them.



ZigBee 3.0

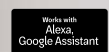

How do they work?

You can connect the scene switch to other smart home devices via a ZigBee gateway connected to your home Wi-Fi network. You can then use the EMOS GoSmart mobile app to set up individual scenes.

You can assign a specific function to each of the button's three positions. Has the sun come out and has the temperature outside gone up? With the press of a single button, you can switch off the lights in the room, lower the external blinds and turn on the humidifier all at the same time.

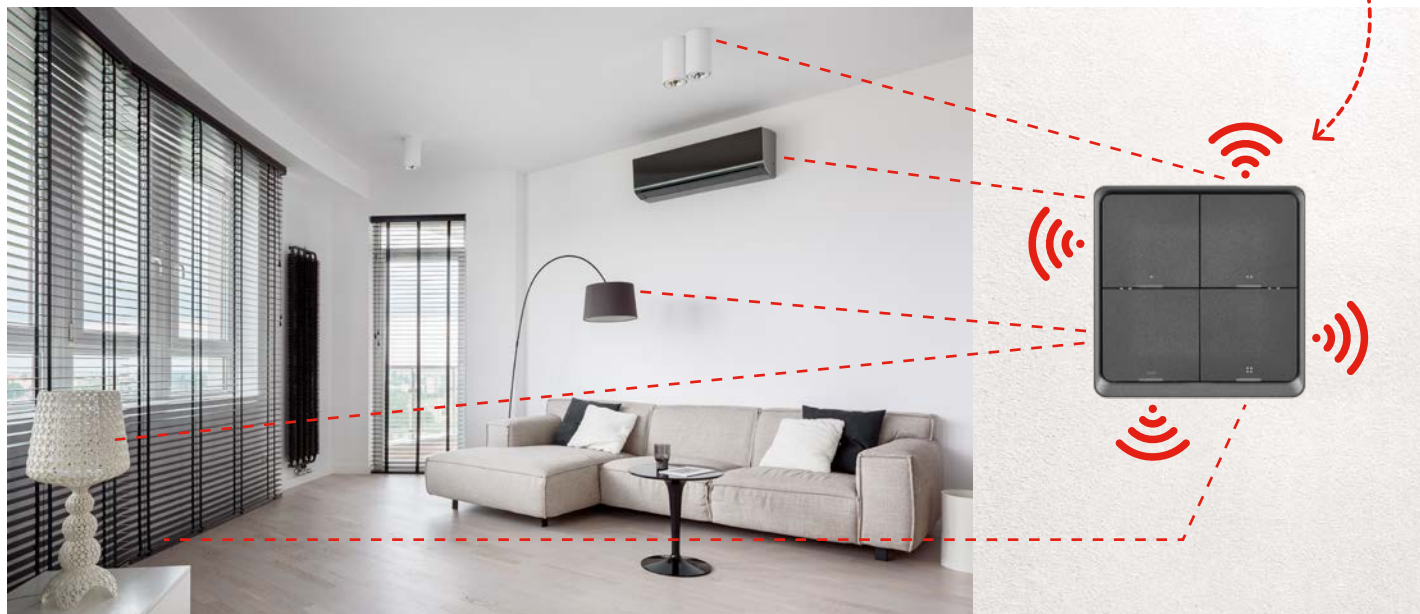
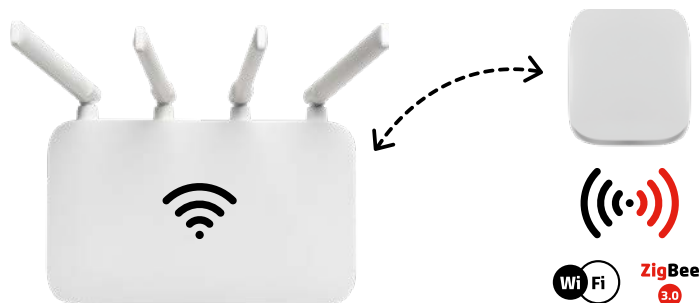

GoSmart Portable ZigBee Scene Controller IP-2001ZB

- number of control buttons:
1 = 3 functions
- compatibility: EMOS GoSmart, TUYA, LIDL, Smartlife, open system
- protocol: Zigbee 3.0
- pairing: automatic, manual
- use: automation
- power supply: CR 2430 3 V

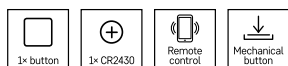

Order code
H5014
Order number
30 69 050 140



GoSmart Portable ZigBee Scene Controller IP-2002ZB

- number of control buttons:
2 = 6 functions
- compatibility: EMOS GoSmart, TUYA, LIDL, Smartlife, open system
- protocol: ZigBee 3.0
- pairing: automatic, manual
- use: automation
- power supply: CR 2430 3 V



Order code
H5015
Order number
30 69 050 150



GoSmart Portable ZigBee Scene Controller IP-2004ZB

- number of control buttons:
4 = 12 functions
- compatibility: EMOS GoSmart, TUYA, LIDL, Smartlife, open system
- protocol: ZigBee 3.0
- pairing: automatic, manual
- use: automation
- power supply: CR 2430 3 V

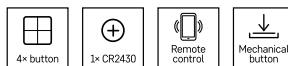

Order code
H5016
Order number
30 69 050 160





Central Units



Expand your smart home with additional sensors and products. With a central unit, you can easily connect them and use them to set up automations. Small wireless sensors can run for several years on the same battery thanks to the ZigBee protocol's low power consumption.



ZigBee 3.0



GoSmart Multifunctional ZigBee Gateway P-2000Z with Bluetooth and Wi-Fi



VIDEO TO WATCH

The ZigBee gateway will serve as the core unit of your smart home and will connect additional sensors and devices into a single, centrally controlled system. This will allow you to configure their automation.

- Wi-Fi/ZigBee 3.0/BLE/SigMesh communication protocols
- easy installation and integration with other sensors and products
- compact dimensions
- maximum number of connected clients: 128
- compatibility: EMOS GoSmart, TUYA, LIDL, Smartlife, open system
- protocol: Wi-Fi/ZigBee 3.0/BLE/SigMesh
- pairing: automatic, manual
- use: indoor
- number of control buttons: 1
- power supply: 5 V DC/1.0 A



BLE SigMesh Wi-Fi

Order code
H5002
Order number
30 69 050 020

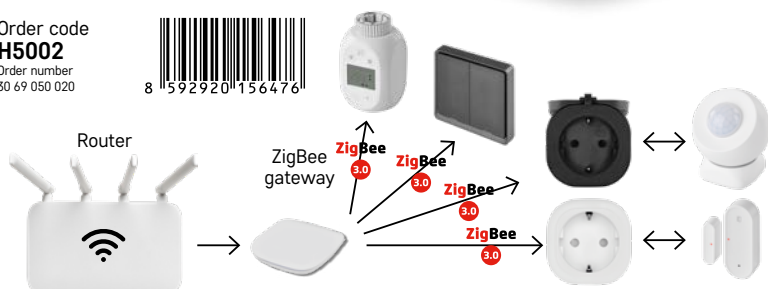

GoSmart Signal Repeater IP-2213Z

The ZigBee signal repeater is an effective device for extending ZigBee signal range. The ideal solution for areas the signal from the ZigBee gateway cannot reach for reasons such as thick walls, electromagnetic interference or the distance between devices.

- minimalist design
- easy installation using a USB adapter
- significant improvement in signal coverage in previously inaccessible areas
- low power consumption
- secure encryption technology
- compatibility: EMOS GoSmart, TUYA, LIDL, Smartlife, open system
- protocol: ZigBee 3.0
- pairing: automatic, manual
- use: automation
- power supply: 5 V DC/1.0 A



Order code
H5022
Order number
30 69 052 030





Extension Cords

Become the master of all the electrical appliances in your household. With smart extension cords you gain perfect oversight over power consumption and can turn your appliances on/off remotely using your mobile device, thus transforming your standard appliances into smart ones. Save time and money.

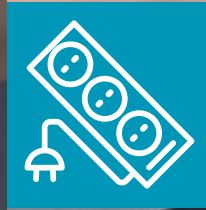

GoSmart Extension Cord

- capable of switching appliances on and off remotely using a mobile phone
- automate operation of connected devices
- energy savings and the ability to monitor consumption
- timer function; child lock
- in the event of a power cut, returns to the state it was in before the cut – ON/OFF
- voltage/current: 250 V~/16 A max.
- maximum load: 3 680 W
- type of insulation: PVC
- conductor: H05VV-F3G 1.5 mm²
- children protection

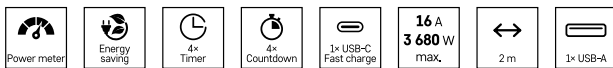

VIDEO TO WATCH

Order code
P1422SM
Order number
19 22 940 201





Sockets

Use smart indoor or outdoor sockets to keep track of your electricity usage and switch them on and off remotely using your mobile device. Save time and money.



- capable of switching appliances on and off remotely using a mobile phone
- automate operation of connected devices
- energy savings and the ability to monitor consumption
- timer function; child lock
- in the event of a power cut, returns to the state it was in before the cut – ON/OFF

GoSmart WiFi socket IP-3002S

- control via Android
- control via iOS
- max. load: 3,680 W
- transmission frequency: 2.4 GHz Wi-Fi
- no. of operations per day: 30
- minimum activation time: 1 minute



Order code
P5531
Order number
19 36 055 310



GoSmart WiFi socket IP44 IP-3006S

- control via Android
- control via iOS
- max. load: 3,680 W
- transmission frequency: 2.4 GHz
- no. of operations per day: 30
- minimum activation time: 1 minute



Order code
P5532
Order number
19 36 055 320



GoSmart Zigbee socket IP-3009S

- control via Android
- control via iOS
- max. load: 3,680 W
- transmission frequency: 2.4 GHz
- no. of operations per day: 30
- minimum activation time: 1 minute



Order code
P5533
Order number
19 36 553 300



GoSmart Zigbee socket IP-3010S

- control via Android
- control via iOS
- max. load: 3,680 W
- transmission frequency: 2.4 GHz
- no. of operations per day: 30
- minimum activation time: 1 minute



Order code
P5534
Order number
19 36 553 400





Modules

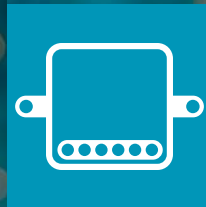

Smart modules are compact in size and easy to connect into a junction box behind a standard switch without the need to replace your old switches that match your interior. You can also connect them directly into the switchboard on a DIN rail thanks to a removable bracket. This gives you greater installation flexibility and the key benefits of smart devices.



Small in size, big in impact. Such are our switching and dimming modules, which allow you to control the lighting in your home via a mobile app. This allows you to adjust the brightness or, for example, the time they switch on or off.

- Timer, Planner (calendar), Countdown
- Easy installation in a junction box behind a light switch or socket
- Dimming modules – smooth dimming down to 0 %
- Ability to configure the behaviour of the connected switch:
 - a) Rocker switch (toggle) – toggling the switch changes the module's state
 - b) Rocker switch (synchronised) – the module tracks the switch's position
 - c) Push-button – a short press triggers the function
- State retention before power cut
- Ability to create groups of modules and control them together
- Sharing devices with family and friends
- Creation of scenes alongside other smart home products
- connection via ZigBee or Wi-Fi protocol
- 1- or 2-channel module, which you can choose depending on which switch you want to turn into a smart switch (single-switch/double-switch)

Easy installation

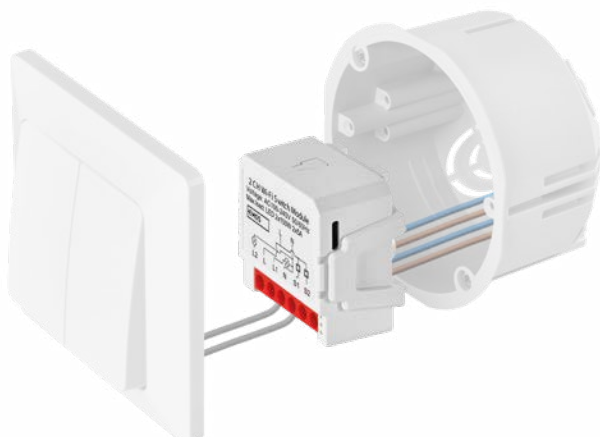

GoSmart Switching Module IP-2201SZ, ZigBee, 1-channel



- compatibility: EMOS GoSmart, TUYA, LIDL, Smartlife, open system
- protocol: ZigBee 3.0
- pairing: automatic, manual
- use: indoor
- number of control buttons: 1
- power supply: 230 V~/50 Hz, max. 0.3 W
- 16 A / 800 W LED



Order code
H5121
Order number
30 69 051 210



- Voltage-free relay
- Universal module for every application
- Switches COM / NO / NC relays
- Ideal for controlling devices with a dry contact (voltage-free) switch, such as boilers, gates or access control systems.



GoSmart Dry Contact Module IP-2241DCW, WiFi



- compatibility: EMOS GoSmart, TUYA, LIDL, Smartlife, open system
- protocol: Wi-Fi
- pairing: automatic, manual
- use: indoor
- number of control buttons: 1
- power supply: 230 V~/50 Hz, max. 0.3 W

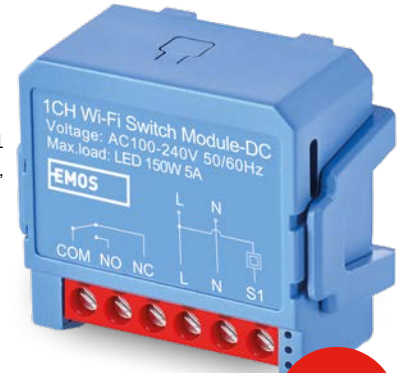

Order code
H5132
Order number
30 69 051 320



GoSmart Switching Module IP-2201SW, WiFi, 1-channel



- compatibility: EMOS GoSmart, TUYA, LIDL, Smartlife, open system
- protocol: Wi-Fi
- pairing: automatic, manual
- use: indoor
- number of control buttons: 1
- power supply: 230 V~/50 Hz, max. 0.3 W
- 16 A / 800 W LED



Order code
H5125
Order number
30 69 051 250



GoSmart Switching Module IP-2202SW, WiFi, 2-channel



- compatibility: EMOS GoSmart, TUYA, LIDL, Smartlife, open system
- protocol: Wi-Fi
- pairing: automatic, manual
- use: indoor
- number of control buttons: 1
- power supply: 230 V~/50 Hz, max. 0.3 W
- 16 A / 800 W LED

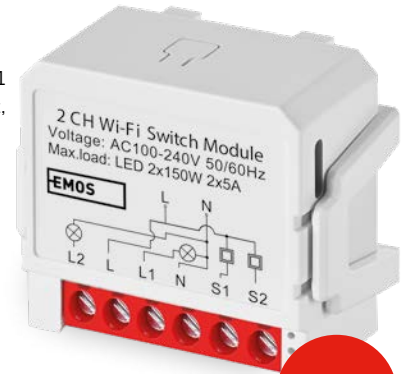

Order code
H5126
Order number
30 69 051 260



GoSmart Dimming Module IP-2211DW, WiFi, 1-channel



- compatibility: EMOS GoSmart, TUYA, LIDL, Smartlife, open system
- protocol: Wi-Fi
- pairing: automatic, manual
- use: indoor
- number of control buttons: 1
- power supply: 230 V~/50 Hz, max. 0.3 W
- Max. load: 150 W LED



Order code
H5127
Order number
30 69 051 270



GoSmart Dimming Module IP-2212DW, WiFi, 2-channel



- compatibility: EMOS GoSmart, TUYA, LIDL, Smartlife, open system
- protocol: Wi-Fi
- pairing: automatic, manual
- use: indoor
- number of control buttons: 1
- power supply: 230 V~/50 Hz, max. 0.3 W
- Max. load: 150 W LED



Order code
H5128
Order number
30 69 051 280



GoSmart Dimming Module IP-2111DZ, ZigBee, 1-channel

- compatibility: EMOS GoSmart, TUYA, LIDL, Smartlife, open system
- protocol: ZigBee 3.0
- pairing: automatic, manual
- use: indoor
- number of control buttons: 1
- power supply: 230 V~/50 Hz, max. 0.3 W

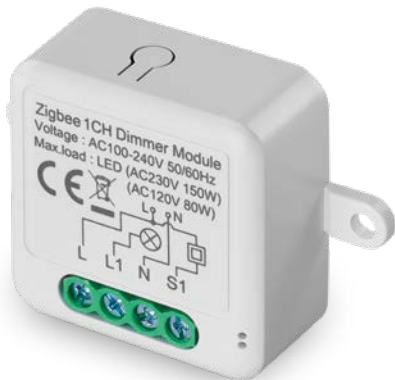

ZigBee 3.0

Order code
H5107
Order number
30 69 051 070



GoSmart Dimming Module IP-2112DZ, ZigBee, 2-channel

- compatibility: EMOS GoSmart, TUYA, LIDL, Smartlife, open system
- protocol: ZigBee 3.0
- pairing: automatic, manual
- use: indoor
- number of control buttons: 1
- power supply: 230 V~/50 Hz, max. 0.3 W



ZigBee 3.0

Order code
H5108
Order number
30 69 051 080



GoSmart Switching Module IP-2103SZ, ZigBee, 1-channel, No Neutral Conductor

- compatibility: EMOS GoSmart, TUYA, LIDL, Smartlife, open system
- protocol: ZigBee 3.0
- pairing: automatic, manual
- number of control buttons: 1
- power supply: 230 V~/50 Hz, max. 0.3 W
- use: indoor

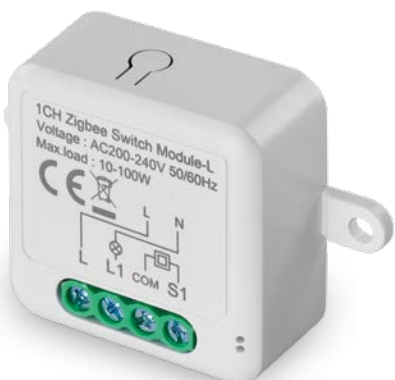

ZigBee 3.0

No Neutral

Order code
H5103
Order number
30 69 051 030



GoSmart Switching Module IP-2104SZ, ZigBee, 2-channel, No Neutral Conductor

- compatibility: EMOS GoSmart, TUYA, LIDL, Smartlife, open system
- protocol: ZigBee 3.0
- pairing: automatic, manual
- number of control buttons: 1
- power supply: 230 V~/50 Hz, max. 0.3 W
- use: indoor



ZigBee 3.0

No Neutral

Order code
H5104
Order number
30 69 051 040



Whether you are at home or on the go, control your curtains, roller shutters or external blinds using a smart motorised module connected via the ZigBee protocol.

- ability to control blinds and shutters according to pre-set scenes and based on the readings from temperature, wind and rain sensors.
- Max. load: 3 A
- additional RF433 MHz receiver for remote control
- ability to set the percentage opening of blinds and shutters, precise calibration
- option to connect a STOP button

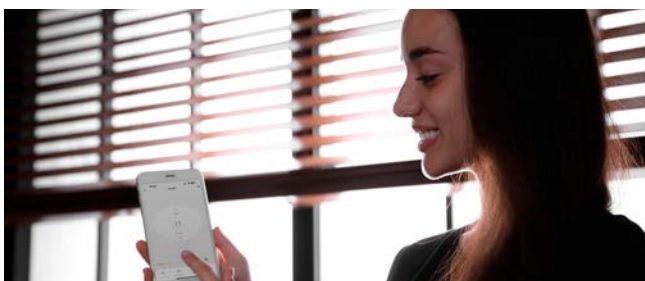

GoSmart Drive Module IP-2121CW, WiFi, 1-channel

- compatibility: EMOS GoSmart, TUYA, LIDL, Smartlife, open system
- protocol: Wi-Fi
- pairing: automatic, manual
- use: indoor
- number of control buttons: 1
- power supply: 230 V~/50 Hz, max. 0.3 W

Wi Fi



Order code
H5129
Order number
30 69 051 290



NEW

GoSmart Drive Module IP-2121CZ, ZigBee, 1-channel

- compatibility: EMOS GoSmart, TUYA, LIDL, Smartlife, open system
- protocol: ZigBee 3.0
- pairing: automatic, manual
- use: indoor
- number of control buttons: 1
- power supply: 230 V~/50 Hz, max. 0.3 W

ZigBee
3.0

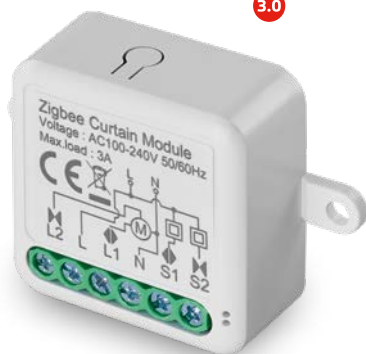

Order code
H5109
Order number
30 69 051 090



GoSmart Drive Module IP-2122CZ, ZigBee, 2-channel

- compatibility: EMOS GoSmart, TUYA, LIDL, Smartlife, open system
- protocol: ZigBee 3.0
- pairing: automatic, manual
- use: indoor
- number of control buttons: 1
- power supply: 230 V~/50 Hz, max. 0.3 W

ZigBee
3.0

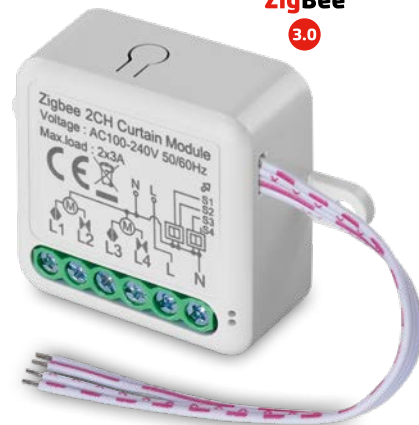

Order code
H5110
Order number
30 69 051 100



GoSmart Garage Module IP-2231SW

This smart module for controlling garage doors will enhance the security of your home and put an end to any worries about whether you have closed your garage door or entrance gate.

- remote control of garage doors using the EMOS GoSmart app on your mobile phone
- universal for use with any drive
- detection of the door/gate position using a magnetic sensor (included) (open/closed) and sending of a notification when the door/gate is in motion
- controllable directly from your car via integration with Android Auto and CarPlay
- ability to create scenes in conjunction with other smart home devices, e.g. when the garage door opens, the garage lights and the light outside the garage come on for 2 minutes to make it easier to park and leave the garage

- compatibility: EMOS GoSmart, TUYA, LIDL, Smartlife, open system
- protocol: Wi-Fi
- pairing: automatic, manual
- use: indoor
- number of control buttons: 1
- power supply: 230 V~/50 Hz, max. 0.3 W
- Max. load: 3 A

Wi-Fi



Order code
H5131
Order number
30 69 051 310





LUMINAIRES AND LIGHT SOURCES

- Light bulbs
- Strips
- Floodlights
- Garden lighting
- Ambient lighting



Create a unique
atmosphere
in your home.



Light Bulbs

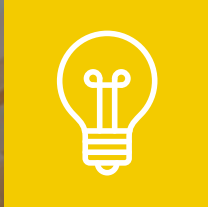

Smart bulbs will become your key to home automation. Create scenes and adjust the lighting of your home, from dimming to various colour tones. Create a pleasant atmosphere and combine quality lighting with smart features.

BENEFITS

- ▶ **circadian rhythm** – automatically adjusts the colour temperature of the light throughout the day to mimic the natural rhythm of sunlight and positively influence our biological clock, sleep and overall comfortable lifestyle
- ▶ **music mode** – the bulb synchronises with the music playing and can flash in time with the beat
- ▶ **scheduling** – setting cycles, sleep mode, light alarm
- ▶ **bulb grouping** – allows you to group bulbs that use the same communication protocol, so you do not have to control each bulb individually; for example, you can create a 'Kitchen' group and control all the kitchen lighting with a single tap.
- ▶ **reverse switch** – a feature lacking in most light bulbs, switching on and off according to the current state
- ▶ **preset scenes** – each bulb has a set of pre-programmed scenes in the app (breathing, smooth colour transitions, etc.), which can be customised to suit your preferences
- ▶ **start-up memory** – a setting that determines how the bulb will behave when switched on – e.g. whether it will light up at the previous brightness, colour temperature or a specific colour
- ▶ **dimming** – all bulbs are dimmable within a range of 100 % to 10 %

Smart Wi-Fi bulbs can be controlled from a mobile app. The bulbs allow pairing into groups and setting different properties such as colour and light intensity exactly as you need.

- control via mobile app
- option to pair multiple bulbs into groups
- ability to dim or change light colour
- accurate RGB colour rendering



GoSmart LED Bulb A60 9 W E27 RGB

- luminous flux: 806 lm
- colour temperature: 2,700–6,500 K
- beam angle: 200°
- compatibility: EMOS GoSmart, TUYA, LIDL, Smartlife



Order code **ZQW514R**
Order number 15 20 503 500



GoSmart LED Bulb A60 11 W E27 RGB

- luminous flux: 1,050 lm
- colour temperature: 2,700–6,500 K
- beam angle: 200°
- compatibility: EMOS GoSmart, TUYA, LIDL, Smartlife



Order code **ZQW515R**
Order number 15 20 503 501



GoSmart LED Bulb A60 14 W E27 RGB

- luminous flux: 1,400 lm
- colour temperature: 2,700–6,500 K
- beam angle: 200°
- compatibility: EMOS GoSmart, TUYA, LIDL, Smartlife



Order code **ZQW516R**
Order number 15 20 503 502



GoSmart LED Bulb CANDLE 4.8 W E14 RGB

- luminous flux: 470 lm
- colour temperature: 2,700–6,500 K
- beam angle: 180°
- compatibility: EMOS GoSmart, TUYA, LIDL, Smartlife



Order code **ZQW322R**
Order number 15 25 501 500



GoSmart LED Bulb MR16 4.8 W GU10 RGB

- luminous flux: 400 lm
- colour temperature: 2,700–6,500 K
- beam angle: 120°
- compatibility: EMOS GoSmart, TUYA, LIDL, Smartlife

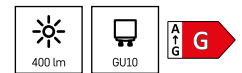

Order code **ZQW832R**
Order number 15 25 500 500





Strips

Create a unique atmosphere in your interior and gain full control over your lighting. Monitor power consumption, create various scenes and animations and set light colours and brightness levels as you need.

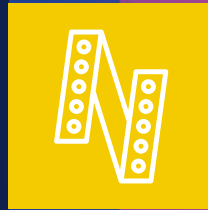

Set the mood in your home with an LED smart strip that easily adapts to your preferences. Whether you want to light up an entire room, create a subtle ambient effect or highlight the details of your furniture, this strip offers endless possibilities. It is a breeze to control – via the app or the included remote.

- control colour, brightness and modes from the app or with the remote
- RGB + CCT technology for a wide range of colours and white colour temperatures
- perfect for general lighting as well as subtle lighting accents
- can be cut to the exact length required
- compatible with smart home systems and automations



GoSmart Wi-Fi LED Strip, 2 m

- protocol: Wi-Fi + BLE
- input power: 11 W
- luminous flux: 750 lm
- colour temperature: 2,700–6,500 K
- dimming
- colour setting (RGB)
- transmission frequency: 2.4 GHz (IEEE 802.11b/g/n)

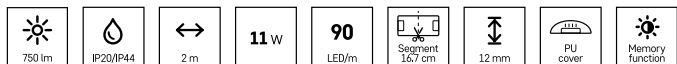

Order code
ZPW218R
Order number
15 51 021 800



GoSmart Wi-Fi LED Strip, 5 m

- protocol: Wi-Fi + BLE
- input power: 21 W
- luminous flux: 1,400 lm
- colour temperature: 2,700–6,500 K
- dimming
- colour setting (RGB)
- transmission frequency: 2.4 GHz (IEEE 802.11b/g/n)

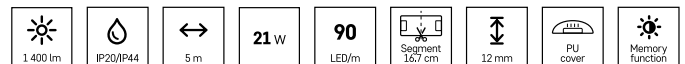

Order code
ZPW518R
Order number
15 51 051 800





Bring a burst of colourful energy and creativity into your space with smart LED neon strips that adapt to any idea. Thanks to its flexibility of shape and individual segment colour control, it transforms any interior into a unique lighting scene. Whether you control them via an app, voice commands or a controller, you have complete freedom to create and adjust the atmosphere to suit your mood, the music or the time of day.

- programmable RGBIC with more than 16 million colours
- segmented control, where each segment can light up in a different colour
- control via a mobile app, voice assistants, or a controller
- pre-set lighting modes + the option to create your own
- variable shaping
- synchronisation with music



VIDEO TO WATCH

GoSmart Flexible LED Strip NEON, 3 m

- protocol: Wi-Fi + BLE
- input power: 23 W
- dimming
- colour setting (RGBIC)
- transmission frequency: 2.4 GHz (IEEE 802.11b/g/n)

Order code
ZPW313I
Order number
15 55 313 000



8 592920 139448

GoSmart Flexible LED Strip NEON, 5 m

- protocol: Wi-Fi + BLE
- input power: 33 W
- dimming
- colour setting (RGBIC)
- transmission frequency: 2.4 GHz (IEEE 802.11b/g/n)

Order code
ZPW513I
Order number
15 55 513 000



8 592920 139462





Floodlights

Create a unique atmosphere with our smart floodlights, which offer simple, app-based control, energy savings, flexibility of use and control over your indoor and outdoor lighting.



Take full control of your outdoor lighting and create just the right atmosphere – whether you are hosting a garden party, relaxing under the pergola or want to stylishly illuminate your façade. These modern smart floodlights combine powerful light output with a soft, diffused glow and fully customisable effects that you can easily control via the app.

- each floodlight can emit a different colour thanks to RGBIC + CCT technology
- the system can be expanded to include up to 6 floodlights as required (3-piece starter kit + max. 3 expansion kits)
- soft, even lighting thanks to the integrated frosted diffuser
- two mounting options: a bar for secure attachment or a stake for driving into the ground
- a compact and flexible solution for a wide range of outdoor applications

GoSmart Outdoor Floodlight, Starter Kit (3 Pcs)

- protocol: Wi-Fi + BLE
- input power: 14 W
- luminous flux: 990 lm
- colour temperature: 3,000–6,500 K
- dimming
- colour setting (RGBIC)
- transmission frequency: 2.4 GHz (IEEE 802.11b/g/n)



Order code
ZIW184R
Order number
15 54 184 000



8 592920 136935

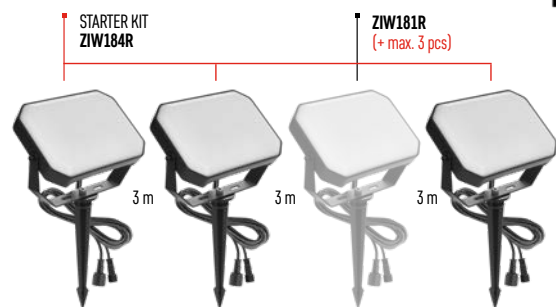

GoSmart Outdoor Floodlight, Expansion Kit (1 Pc)

- protocol: Wi-Fi + BLE
- input power: 4 W
- luminous flux: 330 lm
- colour temperature: 3,000–6,500 K
- dimming
- colour setting (RGBIC)
- transmission frequency: 2.4 GHz (IEEE 802.11b/g/n)



Order code
ZIW181R
Order number
15 54 181 000



8 592920 136959



VIDEO TO WATCH



Garden Lighting

Not just functionality but also an aesthetic experience. Our products are designed to help you create the perfect atmosphere in your garden, on your patio or around your home. Thanks to modern technology, you can use a mobile app to easily control the lighting and tailor it to your needs.

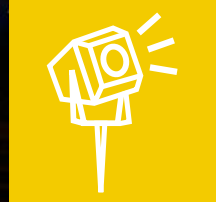

Add a unique atmosphere to your outdoor space with a smart string light that combines the classic look of party bulbs with modern RGBIC effects. Whether you are hosting a party, having a barbecue or simply enjoying a quiet evening in the garden, this string light will help you create exactly the atmosphere you want – easily and effectively.

- each bulb is fitted with a light 'drop' on a wire, which changes colour in sync with it
- programmable RGBIC – over 16 million colour combinations
- synchronisation with music
- adapter with IP44 rating – suitable for outdoor use under a roof
- control via the mobile app – adjust colours, brightness and modes in an instant
- easy to install thanks to a handy hook by each bulb

GoSmart LED String Lights – 15 Party Bulbs, 15 m

- protocol: Wi-Fi + BLE
- input power: 12 W
- dimming
- colour setting (RGBIC)
- transmission frequency: 2.4 GHz (IEEE 802.11b/g/n)

12w	IP65	15x	Timer	Dimmable 10%...100%	20 000 h
-----	------	-----	-------	---------------------	----------

Order code
ZIW17FR
Order number
15 55 017 000



VIDEO TO WATCH



These outdoor spotlights offer over 16 million colours; each spotlight can glow a different colour thanks to the programmable RGBIC, or you can choose from preset modes that will take your garden, façade or driveway to a whole new level.

- programmable RGBIC + CCT (each spotlight can glow in a different colour based on the settings in the app)
- outdoor lighting for houses, gardens, driveways and other outdoor areas
- expandable to up to 8 spotlights (4-piece starter kit + max. 4 expansion kits)
- a narrower beam of light for intense illumination of a specific spot
- spacing between lights up to 3 m
- easy to install using a spike



GoSmart Outdoor Spotlights, Starter Kit (4 Pcs)

- protocol: Wi-Fi + BLE
- input power: 7 W
- luminous flux: 400 lm
- colour temperature: 3,000–6,500 K
- dimming
- colour setting (RGBIC)
- transmission frequency: 2.4 GHz (IEEE 802.11b/g/n)

Order code
ZIW194R
Order number
14 54 194 000

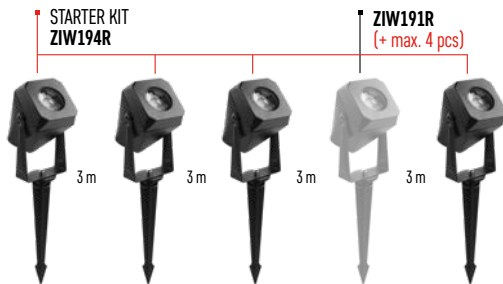

GoSmart Outdoor Spotlight, Expansion Kit (1 pc)

- protocol: Wi-Fi + BLE
- input power: 1.5 W
- luminous flux: 100 lm
- colour temperature: 3,000–6,500 K
- dimming
- colour setting (RGBIC)
- transmission frequency: 2.4 GHz (IEEE 802.11b/g/n)

Order code
ZIW191R
Order number
15 54 191 000



VIDEO TO WATCH





Programmable RGBIC

A technology that enables segmented colour control, thereby dividing the lighting into colour sections. Each light can shine in a different colour, based on the settings in the app.

Ambient Lighting



Transform your living room, bedroom, game room or home office with our decorative lighting. With a wide range of lighting modes and easy control via the mobile app, you can create the perfect atmosphere for reading, a romantic evening or thrilling video game battles.



- RGB + CCT, over 16 million colours
- dimmable in 10 – 100 % range
- interior lighting to create atmosphere, illuminate pictures, walls and details
- powered through a 1.5 m power cable
- synchronisation with music
- other features: memory function for the event of a power cut, timer, lighting modes, control via Amazon Alexa and Google Assistant, etc.



VIDEO TO WATCH

330 lm	7w	IP20	20 000 h	R _a ≥ 80	Dimmable
--------	----	------	----------	---------------------	----------



GoSmart LED Ambient Lamp, Black / White

- protocol: Wi-Fi + BLE
- input power: 7 W
- luminous flux: 330 lm
- colour temperature: 3,000–6,500 K
- dimming
- colour setting (RGB)
- transmission frequency: 2.4 GHz (IEEE 802.11b/g/n)

Order code
ZCW11BR
Order number
15 55 110 000



8 592920 133743



Order code
ZCW11WR
Order number
15 55 111 000



8 592920 133767

This smart lighting system uses an HD screen colour spectrum synchronisation sensor that automatically adjusts the backlight colours to match what is happening on screen, creating an immersive visual experience.



VIDEO TO WATCH

- programmable RGBIC
- synchronisation with music via a microphone
- a wide range of predefined scene and dynamic modes + option to create your own
- a pleasant atmosphere for watching TV that protects your eyesight
- mounted using special brackets without the need for adhesive
- multiple sizes available for TVs with screen sizes of 55", 65" and 75"



GoSmart Ambient RGB LED Lighting behind 55" (139 cm) TVs

- protocol: Wi-Fi + BLE
- input power: 24 W
- luminous flux: 450 lm
- dimming
- colour setting (RGBIC)
- transmission frequency: 2.4 GHz (IEEE 802.11b/g/n)



Order code
ZTV55
Order number
15 51 550 000



GoSmart Ambient RGB LED Lighting behind 65" (164 cm) TVs

- protocol: Wi-Fi + BLE
- input power: 24 W
- luminous flux: 610 lm
- dimming
- colour setting (RGBIC)
- transmission frequency: 2.4 GHz (IEEE 802.11b/g/n)



Order code
ZTV65
Order number
15 51 650 000



GoSmart Ambient RGB LED Lighting behind 75" (189 cm) TVs

- protocol: Wi-Fi + BLE
- input power: 24 W
- luminous flux: 660 lm
- dimming
- colour setting (RGBIC)
- transmission frequency: 2.4 GHz (IEEE 802.11b/g/n)



Order code
ZTV75
Order number
15 51 750 000





Transform the atmosphere in any room with a single touch. Modern smart LED spotlights allow you to customise the colour, brightness, and lighting modes to suit your exact needs – whether you want to create a relaxation area, a creative studio or smart lighting for everyday comfort. Easy to control via the app, voice assistants, or with the controller on the power cable.

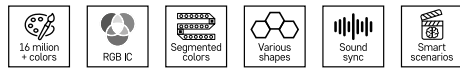

GoSmart LED Spotlight, Starter Kit (12 Pcs)

- protocol: Wi-Fi + BLE
- input power: 7 W
- colour temperature: 3,000–6,500 K
- dimming
- colour setting (RGBIC)
- transmission frequency: 2.4 GHz (IEEE 802.11b/g/n)

Order code
ZIW15CR
Order number
15 55 015 000



- programmable RGBIC + CCT technology for vivid and dynamic colours
- dimming from 10 % to 100 % for maximum comfort
- can be expanded to up to 24 lights (ideal for entire rooms and larger spaces)
- easy to power thanks to the 2 metre power cable
- flexible installation using the supplied 3M tape or screws
- a wide range of features: timer, preset modes, custom settings, etc.



VIDEO TO WATCH

GoSmart LED Spotlight, Expansion Kit (4 Pcs)

- protocol: Wi-Fi + BLE
- input power: 1.9 W
- colour temperature: 3,000–6,500 K
- dimming
- colour setting (RGBIC)
- transmission frequency: 2.4 GHz (IEEE 802.11b/g/n)

Order code
ZIW154R
Order number
15 55 154 000

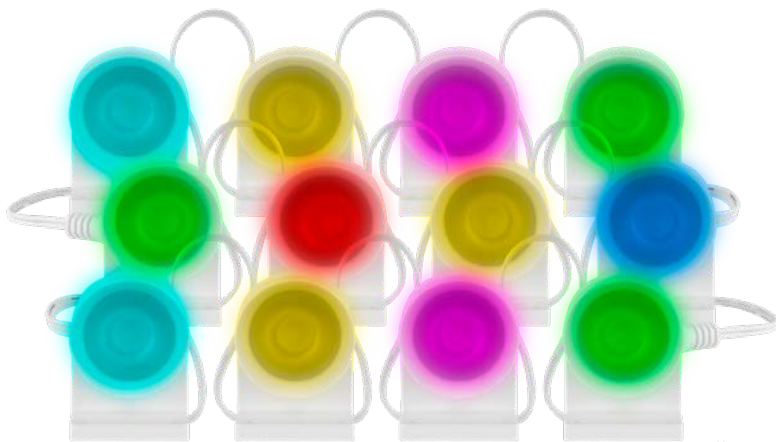

ZIW15CR
STARTER KIT

16 cm 16 cm 16 cm 16 cm 16 cm 16 cm 16 cm 16 cm 16 cm 16 cm 16 cm

ZIW154R
EXPANSION KIT (+ max. 24 pcs)





With these smart hexagonal LED panels, you can create unique lighting that is ideal for game rooms, living rooms, bedrooms and other interior spaces. Thanks to the variability of arrangement, you can let your imagination run wild and create your own works of art.

- programmable RGBIC technology
- dimming range 10–100 %
- max. expansion to 19 panels (10-piece starter kit + max. 3 expansion kits)
- other features: timer, lighting modes, DIY modes, control via mobile app, voice assistants or a controller, etc.



VIDEO TO WATCH



GoSmart LED Hexagon Light, Starter Kit (10 Pcs)

- protocol: Wi-Fi + BLE
- input power: 19 W
- dimming
- colour setting (RGBIC)
- transmission frequency: 2.4 GHz (IEEE 802.11b/g/n)

Order code
ZIW22AR
Order number
15 55 022 000

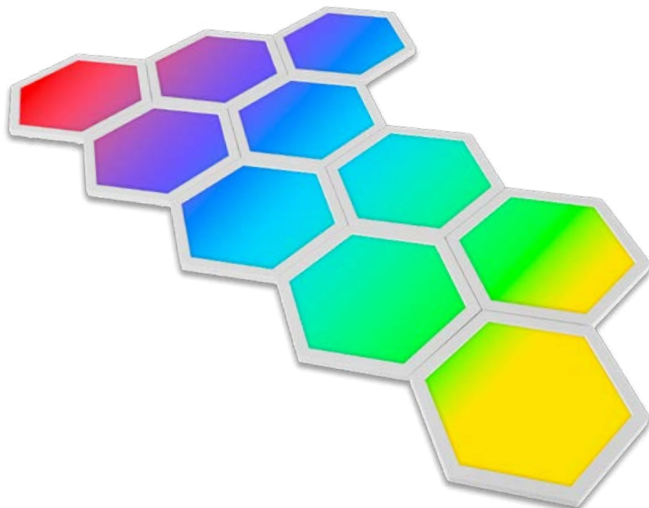

GoSmart LED Hexagon Light, Expansion Kit (3 Pcs)

- protocol: Wi-Fi + BLE
- input power: 1.8 W
- dimming
- colour setting (RGBIC)
- transmission frequency: 2.4 GHz (IEEE 802.11b/g/n)

Order code
ZIW223R
Order number
15 55 223 000

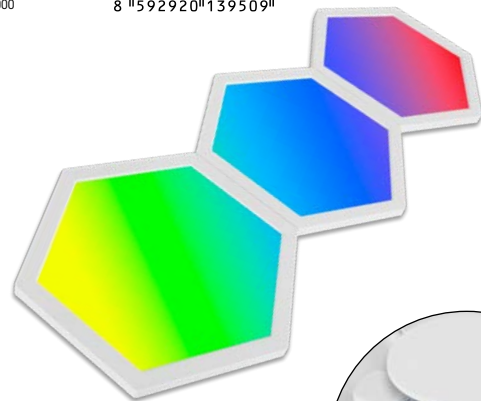

ZIW22AR
STARTER KIT

ZIW223R
EXPANSION KIT (+ max. 19 pcs)





VIDEO TO WATCH



GoSmart LED Hexagon Desk Lamp (6 Pcs)

A modern, smart LED desk lamp for creating the perfect atmosphere for work, relaxation or entertainment. The lamp consists of hexagonal panels that can be arranged into various shapes.

- programmable RGBIC technology with dimming capability from 10 % to 100 %
- controlled via a mobile app, voice assistants, or a controller
- variable placement: on a stand or wall using 3M tape
- powered through a 1.2 m USB-C cable
- other features: timer, lighting modes, DIY modes, synchronisation with music via the mobile app, etc.



- protocol: Wi-Fi + BLE
- input power: 5.5 W
- dimming
- colour setting (RGBIC)
- transmission frequency: 2.4 GHz (IEEE 802.11b/g/n)

Order code
ZIW426R
Order number
15 55 426 000

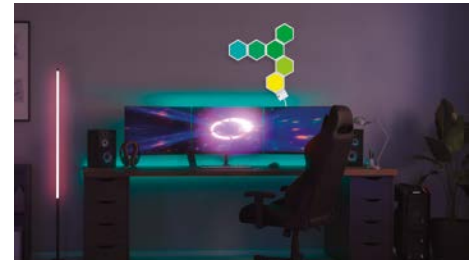

GoSmart LED Floor Lamp

This interior lamp, consisting of 4 segments with a rotation range of up to 180 degrees, allows you to choose from four different lighting directions. The lamp can be placed on the floor or hung on a wall to create modern ambient lighting in your home.

- programmable RGBIC + dimming function 10–100 %
- mounting material included
- synchronisation with music and flashing in rhythm
- other features: timer, lighting modes, DIY modes, control via a mobile app or controller, etc.

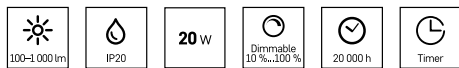

- protocol: Wi-Fi + BLE
- input power: 20 W
- luminous flux: 1,000 lm
- colour temperature: 2,700 K
- dimming
- colour setting (RGBIC)
- transmission frequency: 2.4 GHz (IEEE 802.11b/g/n)

Order code
ZCW34BR
Order number
15 55 034 000





GoSmart LED Lines Light, 9-Piece Set, White/Black

Bring unconstrained lighting design into your home. Lines is a smart LED light consisting of nine light strips and nine hexagonal connectors, which you can arrange exactly as you wish. Thanks to smart control via the app, voice commands or the controller on the cable, you can create a unique atmosphere to suit your current mood.

- RGBIC colour backlighting with smooth dimming from 10 to 100 %
- modular arrangement: strip-to-strip or strip-to-hexagon combinations for a custom design
- powered via a 1.5 m cable with an integrated controller
- includes features such as a timer, dynamic lighting modes, custom scenes, or real-time synchronisation with audio via a mobile app

- protocol: Wi-Fi + BLE
- input power: 34 W
- dimming
- colour setting (RGBIC)
- transmission frequency: 2.4 GHz (IEEE 802.11b/g/n)



VIDEO TO WATCH

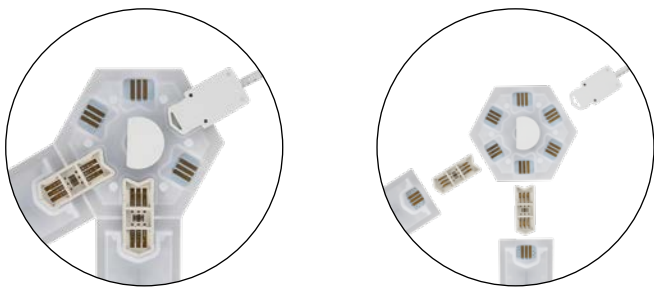
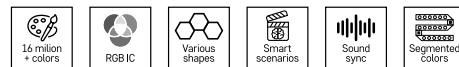

Order code
ZIW249R
Order number
15 55 249 000

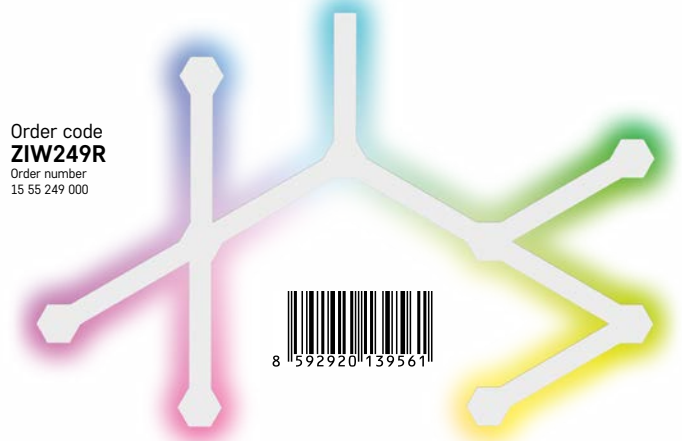

8 1592920 139561



Order code
ZIW269R
Order number
15 55 269 000

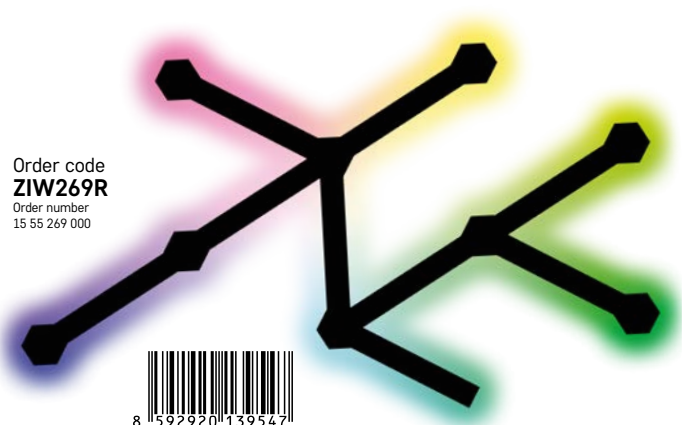

8 1592920 139547



HOUSEHOLD AND GARDEN

- Scales
- For pets
- Irrigation systems

Look after your health,
your pets and your
garden using modern
technology.





Bathroom Scales

Maintain a healthy body, mind and weight with our smart scales. Gain perfect information about your weight and other parameters that influence your healthy lifestyle.

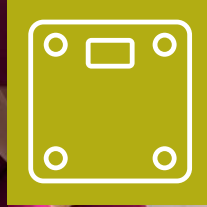

GoSmart Bathroom Scales EV112

The EV112 smart bathroom scales can track up to 18 body metrics and provide you with detailed information about your body. With clear, visual reports, you can track your progress towards achieving your dream figure.

- 18 measurable metrics such as BMI, body fat percentage, muscle mass percentage, your ideal weight and much more
- memory for up to 10 users
- weight capacity up to 180 kg (396 lb)
- weighing accuracy to the nearest 100 g
- stylish glass design with a clear, illuminated LCD screen



- LCD screen
- illuminated display
- surface of the scales: ITO toughened glass
- max. load: 180 kg
- Bluetooth
- BMI – measurement of fat, water and muscle mass
- units of weight: kg, lb

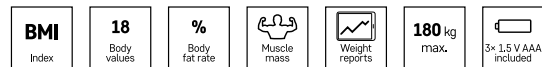

Order code
EV112
Order number
26 17 010 902





VIDEO TO WATCH

For Pets



Give your pet a healthy and happy lifestyle. These smart products, which you control via a mobile app, ensure that your pet's bowl is always stocked with fresh dry food and that they stay well-hydrated, even when you are not at home.

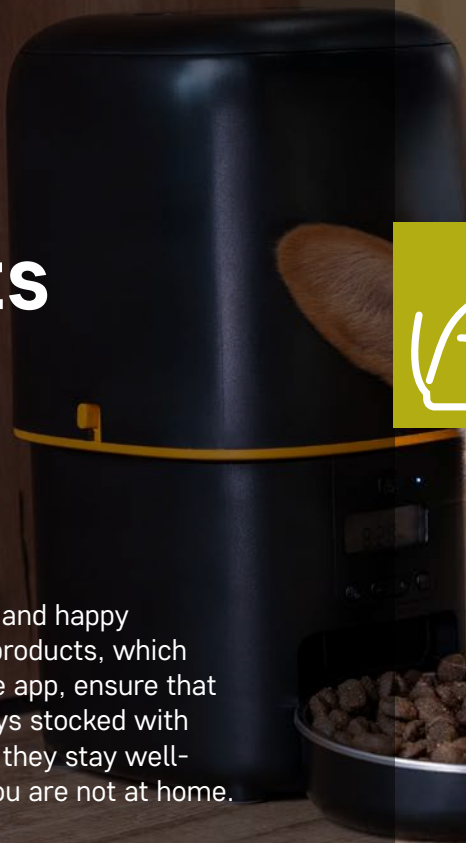

GoSmart Water Fountain PET-202

Ensure a supply of fresh water and encourage your pets to drink regularly. A high-quality 5-layer filter effectively removes heavy metals, dirt and other harmful substances, ensuring maximum water purity.

- alarm for low water level, need for tank cleaning or filter replacement
- silent running with water flow control
- available accessories

- capacity: 2.6 l
- recommendation: small and medium-sized breeds
- compatibility: EMOS GoSmart, TUYA, LIDL, Smartlife, open system
- protocol: Wi-Fi

Order code
H6102
Order number
26 31 610 200



Set of Replacement Filters for a Water Fountain

- includes 4 filters, 4 filters for the pump and a cleaning brush
- filter composition: high-density cotton, coconut fibre, activated charcoal and an ion exchanger
- change the filter every 2–4 weeks
- removes heavy metals, dirt and other impurities



Order code
H6901
Order number
26 31 690 100



Replacement Water Pump for GoSmart Fountains

- includes a 1.5 m USB-A cable
- pack also includes a replacement filter for the pump
- silent running
- ability to control the water flow



Order code
H6903
Order number
26 31 690 300



Our smart feeders can solve your feeding problems and provide a fresh serving of dry food according to a precisely set schedule. Give your pet a healthy and comfortable lifestyle and choose a feeder that suits your needs.

- precise timing and portioning of food tailored to your pet's needs, from anywhere via the mobile app
- serving size 5–6 g
- preserves the freshness of the food
- dual power supply: mains power supply and D-size backup battery in case of a power cut
- container lock
- washable stainless steel bowl
- other features: alert for jammed food, low food levels in the container, adjustable camera, two-way communication and motion detection for models with a camera, etc.

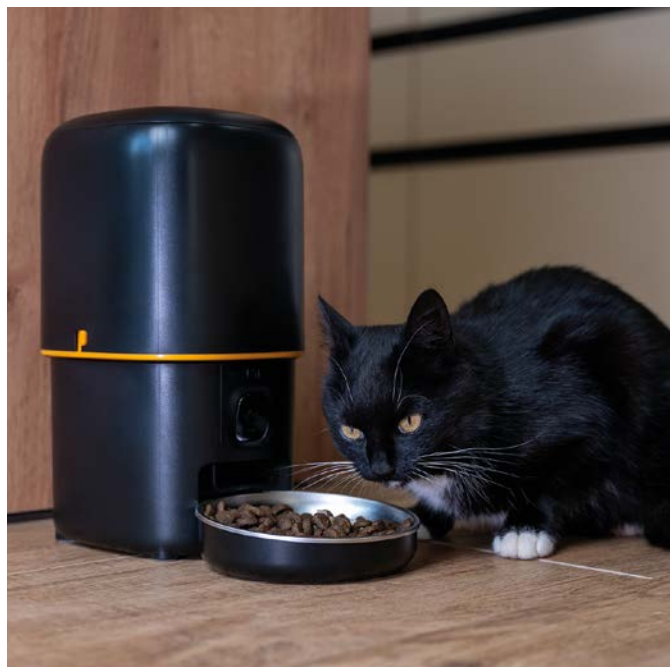
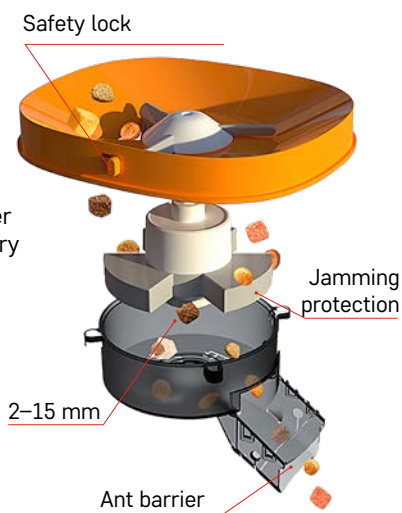

GoSmart Feeder PET-102, 4 l

- capacity: 4 l
- recommendation: small and medium-sized breeds
- one serving: 5 g
- compatibility: EMOS GoSmart, TUYA, LIDL, Smartlife, open system
- protocol: Wi-Fi

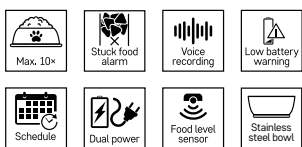

Order code
H6002
Order number
26 31 600 200



GoSmart Feeder with Camera PET-104, 4 l

- capacity: 4 l
- recommendation: small and medium-sized breeds
- one serving: 5 g
- compatibility: EMOS GoSmart, TUYA, LIDL, Smartlife, open system
- protocol: Wi-Fi
- voice communication

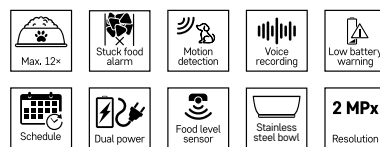

Order code
H6004
Order number
26 31 600 400



GoSmart Feeder with Camera PET-106, 6 l

- capacity: 6 l
- recommendation: medium-sized and large breeds
- one serving: 5 g
- compatibility: EMOS GoSmart, TUYA, LIDL, Smartlife, open system
- protocol: Wi-Fi
- voice communication



Order code
H6006
Order number
26 31 600 600

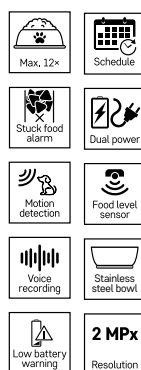



Irrigation Systems

Discover our innovative range of smart irrigation timers, which will revolutionise your garden care. Our products combine modern technology with simple controls to provide you with maximum comfort and efficiency.



The EMOS smart irrigation timer is designed with reliability and your comfort in mind. Thanks to intuitive control via your phone, watering the garden becomes an almost effortless task. You can count on trouble-free operation throughout the season, which will save you a lot of time and energy.

- version with 1 or 2 outlets
- easy operation via mobile app
- compatible with Amazon Alexa and Google Assistant
- scheduling and tracking of irrigation history
- function for delaying watering by 24, 48 or 72 hours in the event of rain
- powered by 4× AA batteries (not included)



GoSmart Irrigation Timer, 1 Outlet

- operating water pressure: 0.5–8 bar
- max. flow rate: 35 l/min
- watering frequency: unlimited
- watering duration: 1 minute – 24 hours
- watering cycles per day: unlimited
- thread: 3/4", 1"
- manual watering

Order code
PW56201
Order number
21 05 562 010



GoSmart Irrigation Timer, 2 Outlets

- operating water pressure: 0.5–8 bar
- max. flow rate: 35 l/min
- watering frequency: unlimited
- watering duration: 1 minute – 24 hours
- watering cycles per day: unlimited
- thread: 3/4", 1"
- manual watering

Order code
PW56202
Order number
21 05 562 020





Let **your home take care of itself**,
and treat yourself to **more time**
for your loved ones and your hobbies.



HOME SECURITY

- 1 Indoor IP cameras
- 2 Outdoor IP cameras
- 3 Video door phones
- 4 Video doorbells
- 5 Wireless doorbells
- 6 Detectors and sensors
- 7 Access control systems



MEASUREMENT AND REGULATION

- 8 Thermostats
- 9 Weather stations and thermometers
- 10 Regulating valves
- 11 Air quality

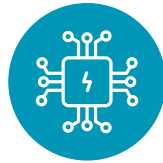

ELECTRICAL WIRING AND CONTROLS

- 12 Scene controllers
- 13 Central units
- 14 Extension cords
- 15 Sockets
- 16 Modules



LUMINAIRES AND LIGHT SOURCES

- 17 Light bulbs
- 18 Strips
- 19 Luminaires
- 20 Christmas lighting
- 21 Floodlights
- 22 Garden lighting
- 23 Ambient lighting



HOUSEHOLD AND GARDEN

- 24 Scales
- 25 For pets
- 26 Irrigation systems



EMOS spol. s r.o.

Lipnická 2844, 750 02 Přerov

e-mail: emos@emos.cz | telephone: +420 581 261 111