



**EMOS**<sup>®</sup>

A brand of **legrand**<sup>®</sup>

# Novelties Catalogue 2026





**35** years of  
**#EMOtions**

**Making**  
**Life**  
**Easy**

# EMOS®

A brand of **legrand®**

## A Czech brand with a European reach

For 35 years, we have been providing high-quality electrical solutions for households and professional users. Reliability, innovation, and long-term partnerships are the foundation of our growth.

We are a stable European distributor of small electrical products. Our products are available in more than 30 countries, where we cooperate with leading retail and wholesale chains as well as specialized distributors. Thanks to our own testing and strong focus on quality, we deliver solutions that serve customers every day.

## The basic philosophy of EMOS

### Optimal price/performance ratio

- our own specialists check the products before they leave the production plant
- our own laboratory and long-term testing ensure the stability and reliability of our product portfolio

### Stock availability

- modern logistics center with an area of 16,000 m<sup>2</sup>
- most of our product range is permanently in stock
- fast delivery throughout Europe

### Fast and easy communication

- direct representation in five countries
- local sales teams
- dedicated B2B sales portals

## Part of the Legrand multinational group

Legrand is a global specialist in electrical and digital building infrastructure. It operates in more than 90 countries worldwide and employs 40,000 people. The group offers high value-added solutions for the commercial and residential segments and invests long-term in innovation and technological development.

[www.emos.eu](http://www.emos.eu)



EMOS is a direct distributor for the Czech Republic, Slovakia, Hungary, Slovenia, Croatia, and Poland.

Direct representation in 5 countries. | Distribution representation across Europe and selected countries overseas. | A stable partner for the B2B segment.



**legrand®**

[www.legrandgroup.com](http://www.legrandgroup.com)

# EMOS dealership

## CZECH REPUBLIC

### Headquarters and logistics centre

EMOS spol. s r.o.  
Lipnická 2844  
750 02 Přerov

ID No.: 19014104  
tax ID No.: CZ19014104  
bank account number:  
296149831/0100  
e-mail: emos@emos.cz

contact person: +420 581 261 111  
customer centre B2B: +420 581 261 270  
sales fax: +420 581 701 332

warehouse: +420 581 261 160 / 290 / 293  
complaints: +420 581 261 281  
GPS: 49.467587°N, 17.448671°E

### OFFICE PRAGUE

EMOS spol. s r.o.  
PB Park, Průmyslová 1306/7  
102 00 Praha 10 – Hostivař

## HUNGARY

EMOS HU Kft.  
Budaörs Office Park, A épület  
2040 Budaörs, Szabadság út 117.

tel.: +36 70 398 5891  
fax: +36 23 41 42 99  
e-mail: info@emos.hu

## POLAND

EMOS PL Sp. z o.o.  
ul. Gałczyńskiego 6  
43-300 Bielsko-Biała

e-mail: biuro@emos.pl

## SLOVAKIA

EMOS SK s.r.o.  
Hlinická 409/22  
014 01 Bytča

ID No.: 36392961  
VAT No.: SK2020104834  
e-mail: info@emos.sk

Sales department:  
+421 415 091 614  
+421 902 966 969

## SLOVENIA

EMOS SI, d.o.o.  
Rimska cesta 92  
3311 Šempeter v Savinjski dolini

tel.: +386 8 205 17 20  
e-mail: narocila@emos-si.si

**Bosnia and Herzegovina |  
Croatia | Montenegro | North  
Macedonia | Serbia**  
Sašo Marinšek  
Managing Director EMOS SI, d.o.o.

GSM: +386 31 517 364  
e-mail: saso.marinsek@emos-si.si

## EXPORT

### Export department

Ladislav Novak  
Export Manager

phone: +420 581 261 207  
GSM: +420 724 597 640  
e-mail: ladislav.novak@emos.cz

### Estonia | Finland | Latvia | Lithuania

Raman Sinevich  
Country Manager

GSM: +371 295 901 79  
e-mail: raman.sinevich@legrand-ext.com

### Austria | Germany | Switzerland

Nikita Maurer  
Country Manager

GSM: +49 151 72161689  
e-mail: nikita.maurer@legrand.com

### Bulgaria | Republic of Moldova | Romania

Szabolcs Cseh  
Country Manager  
Baltic countries

GSM: +40 745 536 783  
e-mail: szabolcs.cseh@legrand-ext.com

### France | Latin America | Portugal | Spain

Nina Novakova  
Key Account Manager

GSM: +420 734 742 008  
e-mail: nina.novakova@emos.cz

### Belgium | Denmark | Greece | Italy | Netherlands

Magdalena Zedkova  
Key Account Manager Junior

GSM: + 420 725 965 625  
e-mail: magdalena.zedkova@emos.cz

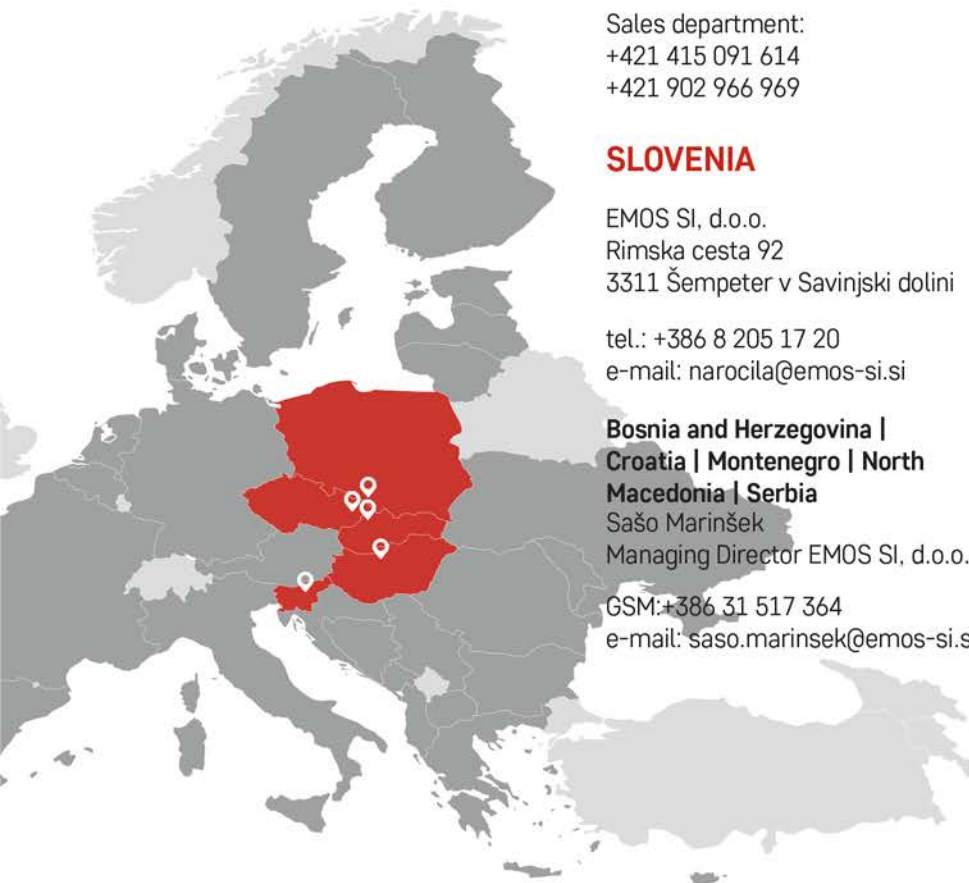

Czech Republic | Hungary | Poland | Slovakia | Slovenia

Albania | Austria | Belgium | Bosnia and Herzegovina | Bulgaria | Chile | Colombia | Croatia | Cyprus | Denmark | Estonia | Finland | France | Germany | Greece | Italy | Latvia | Lithuania | Mauritius | Montenegro | Netherlands | North Macedonia | Norway | Peru | Portugal | Republic of Moldova | Romania | Serbia | Spain | Sweden | Switzerland | Ukraine

# EMOS GoSmart

Smart living is even more affordable

Create your own smart home with EMOS GoSmart smart devices and others compatible with the TUYA platform. Connect individual products, set up automate their activities and control them remotely with the fully localized and intuitive mobile app.



## SECURITY HOME

- Indoor IP cameras
- Outdoor IP cameras
- Video door phones
- Video doorbells
- Wireless doorbell
- Sensors
- Access control systems



## MEASUREMENT AND REGULATION

- Thermostats
- Weather stations and thermometers
- Control valves
- Air quality

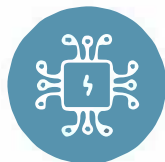

## ELECTRICAL INSTALLATIONS AND CONTROLS

- Scenic controls
- Smart hubs
- Extension leads
- Sockets
- Modules



## LUMINAIRES AND LIGHTING SOURCES

- Light bulbs
- LED Strips
- Luminaires
- Christmas lights
- Floodlights
- Garden lighting
- Ambient lighting



## HOME AND GARDEN

- Scales
- Pet care
- Irrigation systems



EMOS GoSmart



EMOS GoSmart  
is here to make your  
life more pleasant,  
safe and convenient.



EMOS GoSmart

Making Life Easy

[www.emosgosmart.eu](http://www.emosgosmart.eu)

# EMOS GoSmart products

Optimal price/  
performance ratio

With the affordable prices and excellent quality of EMOS GoSmart products, the smart home system becomes accessible to everyone. You can easily create your smart home with them without complicated renovation and installation of equipment.



WIDE RANGE

Dozens of EMOS GoSmart products are developed together with the world's leading manufacturers and industry leaders.



OPTIMAL PRICE AND QUALITY

EMOS GoSmart products are subject to quality control directly at the manufacturer and in our laboratory.



THE ONLY MOBILE APP

The EMOS GoSmart app allows you to control your device via your mobile device from anywhere.



TECHNICAL SUPPORT

We will provide you with technical support and help you get your EMOS GoSmart products up and running.



COMPATIBILITY AND EXPANDABILITY

Expand your smart home with EMOS GoSmart products and thousands of other TUYA-compatible products.

## Advanced technology

EMOS GoSmart products communicate over a Wi-Fi network, Bluetooth or ZigBee communication protocols. You can even use voice control with their compatibility with Amazon Alexa and Google Assistant.

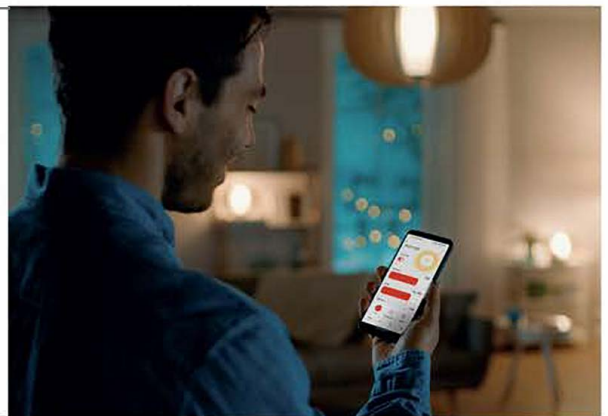
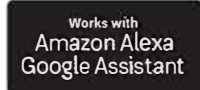

## Data security and compatibility

System priorities of EMOS GoSmart

The foundation of the EMOS GoSmart system is the TUYA global platform. This platform meets the most demanding security requirements and, using encrypted communication, allows the individual devices in a smart home to be connected while maintaining compatibility and ease of use.

Renowned brands that have chosen the TUYA platform for their smart devices include HAMA, LIDL, LEDVANCE, PHILIPS and many others.

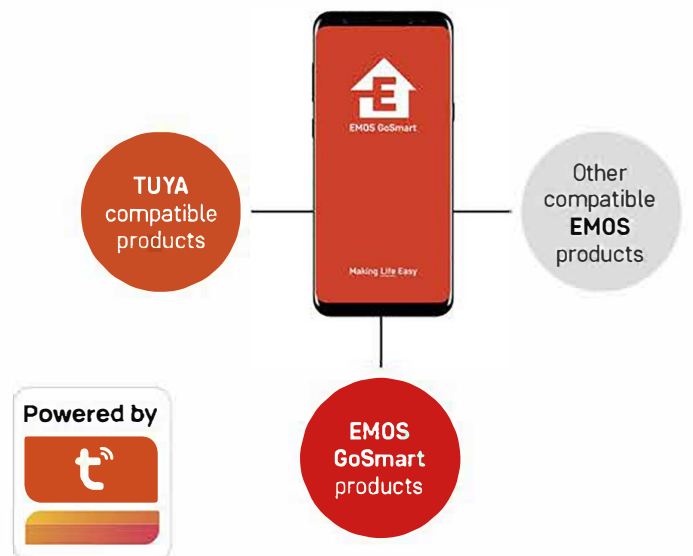

# EMOS GoSmart app

## Full localisation and ease of use

The EMOS GoSmart app makes it easy to control all your smart home devices via your Android or iOS mobile phone or tablet. Thanks to the perfect localisation, you can communicate with it in your native language.



### Smart control of your home

Smart control of your home

Control multiple devices

Instant connection from anywhere

Create and use intelligent scenarios

Share with your family in one tap

Easy control directly from your car



Without complicated settings, the EMOS GoSmart app gives you an up-to-date overview of what's happening in your home and lets you conveniently control all your smart devices remotely.



### FULL LOCALISATION

With full localisation, you'll be up and running with the app. You can communicate in your native language.



### EASY TO USE

You don't have to worry about complicated app control. Easy for everyone to use.



### SMART SCENARIOS

Let your products work together with smart scenarios.



### DEVICE MANAGEMENT

All smart home devices can be controlled with the app from anywhere.



### SMART ALERTS

The app alerts you to what's happening in your home with notifications.

Let your household take care of itself and give yourself more time for your loved ones and interests.

<b>Batteries</b> .....	<b>12</b>	PIR sensors .....	56
GP Batteries .....	12	Microwave sensors .....	58
GP Consumer batteries .....	12	Twilight sensors .....	59
GP Lithium .....	12	Decorations .....	60
GP Ultra lithium cylindrical .....	12	Connecting systems .....	60
GP Lithium button .....	13	PREMIUM connect system .....	60
GP Ultra Plus lithium button .....	13	Nano chains .....	63
GP Alkaline button .....	14	Nano chains cluster .....	63
GP Ultra Plus alkaline button .....	14	Decorations .....	64
GP Consumer batteries .....	15	Projectors .....	64
GP Zinc air .....	15	Garlands .....	65
<b>Battery chargers, powerbanks, USB chargers</b> .....	<b>17</b>	Bethlehems .....	66
Battery chargers .....	17	LED candles .....	66
GP Battery chargers .....	17	Other decorations .....	67
USB chargers .....	18	<b>Weather stations, thermometers, scales, others</b> .....	<b>68</b>
Universal adaptors .....	18	Weather stations .....	68
<b>Portable Lighting</b> .....	<b>20</b>	Weather stations GoSmart .....	68
EMOS .....	20	Weather stations .....	69
LED Plastic Flashlights .....	20	Thermometers .....	70
LED Headlights .....	21	Thermometers .....	70
LED Work Lights .....	22	Spare sensors .....	71
LED Rechargeable Work Lights .....	22	<b>TV and audio accessories</b> .....	<b>72</b>
LED Night Lights .....	23	TV wall mounts .....	72
LED Battery Night Lights .....	23	Universal remote controllers OFA .....	74
LED 230 V Night Lights .....	24	<b>Power supply extension cords, cable reels, plugs, accessories</b> .....	<b>75</b>
EMOS .....	24	Power supply extension cords and sockets .....	75
LED Flashlights display box .....	24	FRENCH Power supply extension cords and sockets .....	75
LED Keychains display box .....	25	Single socket extension cords .....	75
<b>Lighting</b> .....	<b>26</b>	1-phase 16A with PVC insulation .....	75
Light sources .....	26	Two-cores PVC .....	76
LED bulbs .....	26	SCHUKO Power supply extension cords and sockets .....	77
Classic .....	26	Single socket extension cords .....	77
Basic .....	32	1-phase 16A with PVC insulation .....	77
Light sources .....	33	Surge protectors .....	78
ECO halogen .....	33	Surge protectors EMOS FRENCH .....	78
LED tubes, tubes .....	34	Surge protectors EMOS SCHUKO .....	80
PROFI PLUS .....	34	Sockets, plugs, adaptors, timers, others .....	82
Light sources .....	36	Adaptors .....	82
Car-light bulbs .....	36	Travel adaptors .....	82
Luminaires .....	37	<b>HF signal receiving components, antennas, small electronic, accessories</b> .....	<b>84</b>
Floodlights .....	37	Accessories .....	84
CLASSIC .....	37	ZigBee GoSmart .....	84
TAMBO .....	37	<b>Videophones, doorbells</b> .....	<b>85</b>
Work Lights .....	39	Home videophones, sets .....	85
PROFI .....	39	Videophones and video doorbells GoSmart .....	85
ELION .....	39	Home videophones .....	86
CLASSIC .....	41	Cameras, Surveillance .....	87
ACCO .....	41	GoSmart Cameras .....	87
ESSENTIAL .....	42	Alarms .....	89
GLARO .....	42	Alarms GoSmart .....	89
LED Panels .....	44	Alarms .....	89
PROFI PLUS .....	44	<b>Multimeters, testers</b> .....	<b>90</b>
LUXXO .....	44	Multimeters, measuring cables .....	90
CLASSIC .....	45	Testers .....	93
DIXXO .....	45	Measuring instruments .....	95
Surface Luminaires .....	46	<b>Thermostats, CO and smoke alarms</b> .....	<b>96</b>
EXCLUSIVE .....	46	Thermostats .....	96
ILVI .....	46	Thermostats GoSmart .....	96
SABI .....	48	Thermostats .....	97
REMI .....	48	Detectors .....	99
PROFI .....	49	CO and smoke detectors .....	99
TIVI .....	49	<b>Installation material, tapes</b> .....	<b>100</b>
Cabinet Luminaires .....	50	Installation material .....	100
CLASSIC .....	50	Sockets, switches .....	100
GLASO .....	50	EMOS .....	100
Lamps and desk lamps .....	52	IP54/IP44 .....	100
Desk lamps .....	52	Modules GoSmart .....	101
Grow lamps .....	54	EMOS .....	103
Sensors .....	55	CYKLONE .....	103
Sensors GoSmart .....	55	Installation material .....	104



Terminal blocks .....	104
Fixing of cables, clips .....	106
Tapes .....	109
Other tapes .....	109



# Batteries

## GP Batteries

## GP Consumer batteries

## GP Lithium

### GP Ultra lithium cylindrical



- high-capacity batteries for demanding devices
- lightweight design with long lifespan
- resistant to extreme temperatures
- suitable for smoke detectors, cameras, and other devices
- shelf life up to 10 years



- chemical constitution: lithium
- type: CR123A (CR123AU, CR17345)
- voltage: 3 V
- capacity: 1 400 mAh
- dimensions: 17.0 × 34.5 mm
- weight: 16 g
- operating temperature: -40 °C to +60 °C
- packaging: 2 pcs, blister



4 891199 237447

**B15012U**

2/-/20/900

10 22 000 112

CR123AU

# GP Batteries

## GP Consumer batteries

### GP Lithium button

#### GP Ultra Plus lithium button



- compact batteries with high energy density
- long shelf life and reliable performance
- ideal for smartwatches, key fobs, and medical devices
- wide operating temperature range
- shelf life up to 10 years

energy  
lock5  
years  
storageready  
to use

- chemical constitution: lithium
- type: GP CR2016
- voltage: 3 V
- capacity: 90 mAh
- dimensions: 20.0 × 1.6 mm
- weight: 1.5 g
- operating temperature: -20 °C to +60 °C
- packaging: 2 pcs, blister



4 891199 236402

**B15163UP**

10 42 201 623

2/-/20/720

GP CR2016

- chemical constitution: lithium
- type: GP CR2025
- voltage: 3 V
- capacity: 165 mAh
- dimensions: 20.0 × 2.5 mm
- weight: 2.5 g
- operating temperature: -20 °C to +60 °C
- packaging: 2 pcs, blister



4 891199 236396

**B15253UP**

10 42 202 523

2/-/20/720

GP CR2025

- chemical constitution: lithium
- type: GP CR2032
- voltage: 3 V
- capacity: 240 mAh
- dimensions: 20.0 × 3.2 mm
- weight: 3.1 g
- operating temperature: -20 °C to +60 °C
- packaging: 2 pcs, blister



4 891199 236389

**B15323UP**

10 42 203 223

2/-/20/720

GP CR2032

**EMOS**A brand of 

www.emos.eu

Order Code  
Item NumberPackaging  
Type

- chemical constitution: lithium
- type: GP CR2032
- voltage: 3 V
- capacity: 240 mAh
- dimensions: 20.0 × 3.2 mm
- weight: 3.1 g
- operating temperature: -20 °C to +60 °C
- packaging: 200 pcs, display box



4 891199 236815

**B15325UP**

200/-/200/800

10 42 203 225

GP CR2032

## GP Batteries

## GP Consumer batteries

## GP Alkaline button

### GP Ultra Plus alkaline button



- small batteries with long lifespan
- suitable for watches, calculators, and other small devices
- stable performance and reliability
- wide compatibility with various devices
- shelf life up to 3 years

- chemical constitution: alkaline
- type: GP A76F (AG13, LR44, LR1154, V13GA, PX76A)
- voltage: 1.5 V
- capacity: 110 mAh (discharge load 1.6 kOhm)
- dimensions: 11.6 × 5.4 mm
- weight: 1.7 g
- operating temperature: 0 °C to +45 °C
- packaging: 2 pcs, blister



4 891199 236419

**B13763UP**

2/-/20/1,500

10 41 007 623

GP A76F

# GP Batteries

## GP Consumer batteries

### GP Zinc air



- high-capacity batteries with stable discharge performance
- activated after removing the protective foil
- suitable for hearing aids and other medical devices
- lightweight design for comfortable wear
- eco-friendly solution without mercury
- shelf life up to 3 years

- chemical constitution: zinc-air
- type: GP ZA10 (7005ZD, PR70)
- voltage: 1.45 V
- capacity: 90 mAh (discharge load 1.5 kOhm)
- dimensions: 5.8 × 3.6 mm
- weight: 0.3 g
- operating temperature: -10 °C to +50 °C
- packaging: 6 pcs, blister



4 043752 445985

**B35106**

6/60/300/3,000

10 44 001 026

GP ZA10F

- chemical constitution: zinc-air
- type: GP ZA13 (7000ZD, PR48)
- voltage: 1.45 V
- capacity: 290 mAh (discharge load 625 Ohm)
- dimensions: 7.9 × 5.4 mm
- weight: 0.8 g
- operating temperature: -10 °C to +50 °C
- packaging: 6 pcs, blister



4 043752 445961

**B35136**

6/60/300/3,000

10 44 001 306

GP ZA13F

- chemical constitution: zinc-air
- type: GP ZA312 (7002ZD, PR41)
- voltage: 1.45 V
- capacity: 170 mAh (discharge load 1.0 kOhm)
- dimensions: 7.9 × 3.6 mm
- weight: 0.5 g
- operating temperature: -10 °C to +50 °C
- packaging: 6 pcs, blister



4 043752 445978

**B35126**

6/60/300/3,000

10 44 031 206

GP ZA312F



www.emos.eu

Order Code  
Item Number

Packaging  
Type

- chemical constitution: zinc-air
- type: GP ZA675 (7003ZD, PR44)
- voltage: 1.45 V
- capacity: 620 mAh (discharge load 300 Ohm)
- dimensions: 11.6 × 5.4 mm
- weight: 1.8 g
- operating temperature: -10 °C to +50 °C
- packaging: 6 pcs, blister



4 043752 445954

**B35756**

6/60/300/3,000

10 44 067 506

GP ZA675F

# Battery chargers, powerbanks, USB chargers



## Battery chargers

### GP Battery chargers

- unique new design concept of NiMH battery chargers
- USB power supply and small size allow you to charge anytime, anywhere
- even basic models offer quick and smart charging
- high-quality GP rechargeable batteries and micro USB cable included
- “Pro” model with LED screen and advanced features



auto on/off



smart diagnostics



charge everywhere



- type of charger: intelligent
- charger design: USB-C
- power source: USB 5 V/1 A
- size of the charged cells: AAA, AA
- special features: PD charging compatible
- number of cells inside the package: 4
- type of cells inside the package: AA ReCyko 2 100
- charging time of the enclosed cells: 6:00
- number of charging channels: 4
- number of batteries charged: 1 to 4
- charging current for AA: 1 400 mA/400 mA × 4
- charging current for AAA: 1 400 mA/400 mA × 4
- charging time AA 2 700 mAh: 7:30
- charging time AAA 1 000 mAh: 3:30
- packaging: 1 pc, small paper box



charging time



ready to use



year storage



charging cycles



4 891199 235146

**B50434**

16 04 842 301

1/-/6/12

B423

- type of charger: intelligent
- charger design: USB-C
- power source: USB 5 V/2 A
- size of the charged cells: AAA, AA
- special features: PD charging compatible, Flexi Char
- number of charging channels: 4
- number of batteries charged: 1 to 4
- charging current for AA: 1200 mA (4 x AA)
- charging current for AAA: 800 mA (4x AAA)
- charging time AA 2 700 mAh: 2:45
- charging time AAA 1 000 mAh: 1:30
- packaging: 1 pc, small paper box



battery health care



capacity check



individual charging



4 891199 235160

**B534530**

16 04 845 300

1/-/6/12

M453

## USB chargers

- a choice of models supporting GaN technology and BASIC economically advantageous adapters
- GaN technology enables faster and more powerful charging while maintaining a compact size
- more USB ports, the ability to charge multiple devices at once
- most models support PD fast charging protocol
- Intelligent features for protection of connected devices

max. output 1× USB: A: 5 V/3 A – 9 V/2 A – 12 V/1,5 A (18 W); C: 5 V/3 A – 9 V/3 A – 12 V/2,5 A (30 W) = max. output total: 48 W = input voltage: 12–24 V DC = charging: fast = number of USB outputs: 2 = protection against overload, overvoltage and short circuit = designed for: smartphone, tablet = LED indicators = dimensions: 28 × 36 × 65 mm = packaging: 1 pc, box



**V02C48** 1/-/10/60  
17 04 023 400 V02C48

max. output 1× USB: A: 5 V/3 A – 9 V/3 A – 12 V/2,25 A – 20 V/1,35 A (27 W); C: 5 V/3 A – 9 V/3 A – 12 V/3 A – 15 V/3 A – 20 V/3,25 A (65 W) = max. output total: 65 W = input voltage: 100–240 V~ 50/60 Hz = charging: fast = number of USB outputs: 2 = protection against overload, overvoltage and short circuit = designed for: smartphone, tablet, notebook = dimensions: 45 × 86 × 53 mm = packaging: 1 pc, small paper box

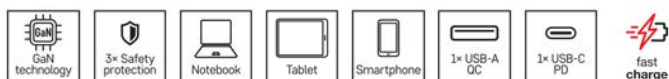

**V1TG65** 1/-/10/60  
17 04 023 500 V1TG65

## Universal adapters

- EMOS adapters come with a set of replaceable connectors
- SMPS suitable for light-current devices (torches, antennas)

input voltage: 100–240 V~ 50/60 Hz = protection against overload, overvoltage and short circuit = designed for: universal = LED indicators = output voltage: 3 V, 4.5 V, 5 V, 6 V, 7.5 V, 9 V, 12 V = output current: max. 600 mA = size of the connector: B 3,5/15; C 3,0x1,0/10; D 5,0x2,1/12; G 5,5x2,5/13; H 3,5x1,35/11; I 4x 1,7/12; S 2,35x0,75/8,7 = power supply type: cable + set of DC connectors = dimensions: 37 × 66 × 67 mm = packaging: 1 pc, box



**N3110N** 1/-/10/40  
17 03 060 022 N3110N



www.emos.eu

Order Code  
Item Number

Packaging  
Type

max. output 1× USB: 5 V/2.0 A/10 W = max. output total: 5 V/2.0 A/10 W = input voltage: 100–240 V~ 50/60 Hz = number of USB outputs: 1 = protection against overload, overvoltage and short circuit = designed for: universal = LED indicators = output voltage: 3 V, 4.5 V, 5 V, 6 V, 7.5 V, 9 V, 12 V = output current: max. 1 000 mA = size of the connector: B 3,5/15; C 3,0x1,0/10; D 5,0x2,1/12; G 5,5x2,5/13; H 3,5x1,35/11; I 4x 1,7/12; S 2,35x0,75/8,7 = power supply type: cable + set of DC connectors + USB out = dimensions: 50 × 84 × 71 mm = packaging: 1 pc, box



**N3111N** 1/-/10/40  
17 03 100 022 N3111N



max. output 1× USB: 5 V/2.0 A/10 W = max. output total: 5 V/2.0 A/10 W = input voltage: 100–240 V~ 50/60 Hz = number of USB outputs: 1 = protection against overload, overvoltage and short circuit = designed for: universal = LED indicators = output voltage: 3 V, 4.5 V, 5 V, 6 V, 7.5 V, 9 V, 12 V = output current: max. 1 500 mA = size of the connector: B 3,5/15; C 3,0x1,0/10; D 5,0x2,1/12; G 5,5x2,5/13; H 3,5x1,35/11; I 4x 1,7/12; S 2,35x0,75/8,7 = power supply type: cable + set of DC connectors + USB out = dimensions: 50 × 84 × 71 mm = packaging: 1 pc, box



**N3112N** 1/-/10/40  
17 03 150 022 N3112N



max. output 1× USB: 5 V/2.0 A/10 W = max. output total: 5 V/2.0 A/10 W = input voltage: 100–240 V~ 50/60 Hz = number of USB outputs: 1 = protection against overload, overvoltage and short circuit = designed for: universal = LED indicators = output voltage: 3 V, 4.5 V, 5 V, 6 V, 7.5 V, 9 V, 12 V = output current: max. 2 250 mA = size of the connector: B 3,5/15; C 3,0x1,0/10; D 5,0x2,1/12; G 5,5x2,5/13; H 3,5x1,35/11; I 4x 1,7/12; S 2,35x0,75/8,7 = power supply type: cable + set of DC connectors + USB out = dimensions: 50 × 84 × 71 mm = packaging: 1 pc, box



**N3113N** 1/-/10/40  
17 03 225 022 N3113N



# Portable Lighting



## EMOS

### LED Plastic Flashlights

- efficient, yet inexpensive light source
- compact and light
- battery-powered or rechargeable
- beam range over 100 m
- long lighting time

- source of light: 3× COB LED + red LED
- maximal light output: 350 lm
- maximal beam distance: 20 m
- number of lighting modes: 5
- runtime: 2–4.5 h
- impact resistance
- waterproof: no
- rechargeable
- battery: Li-Ion

- battery type: 1 800 mAh/3.7 V
- batteries included
- recharge time: 5 hrs
- power connector type: micro USB
- features: swivel handle
- dimensions: 270 × 50 × 245 mm
- weight: 590 g
- packaging: 1 pc, paper box



**P4010** 1/-/4/8  
14 40 041 500 P4010

- source of light: SMD LED + LED
- maximal light output: 25 lm
- maximal beam distance: 5 m
- number of lighting modes: 4
- runtime: 14–65 hrs
- impact resistance
- waterproof: no
- rechargeable
- battery: Li-Ion

- battery type: 1 200 mAh/3.7 V
- batteries included
- recharge time: 2,5 h
- power connector type: USB-C
- dimensions: 65 × 60 × 155 mm
- weight: 152 g
- packaging: 1 pc, box



**P3216** 1/-/-/30  
14 50 000 560 P3216

# LED Headlights

- indispensable part of outdoor gear
- selected models contains top quality CREE LED chips
- battery-powered or rechargeable
- multiple light modes
- longer lighting time at lower intensity
- multiple light sources combined for various uses

source of light: LED = maximal light output: 80 lm = maximal beam distance: 7 m = number of lighting modes: 6 = runtime: 5-10 hrs = impact resistance = waterproof: no = charging = power supply: Li-pol = battery type: 500 mAh/3,7 V = batteries included = special function: quick shutdown = accessories: power cable = dimensions: 50 × 60 × 37 mm = weight: 55 g = packaging: 1 pc, paper blister

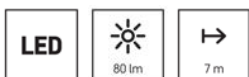

**P3543** 1/-/10/40  
14 41 351 900 P3543

source of light: LED = maximal light output: 500 lm = maximal beam distance: 120 m = number of lighting modes: 2 = runtime: 1-4 hrs = reflective head strap = impact resistance = waterproof: no = charging = power supply: Li-Ion = battery type: 800 mAh/3,7 V = batteries included = special function: battery protection = accessories: USB-C cable = dimensions: 80 × 29 × 30 mm = weight: 60 g = packaging: 1 pc, small paper box

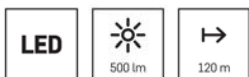

**P3544** 1/-/6/24  
14 41 361 900 P3544

source of light: 3× LED = maximal light output: 175 lm = maximal beam distance: 50 m = number of lighting modes: 5 = runtime: 2-4.5 h = impact resistance = waterproof: yes (IP43) = charging = power supply: Li-pol = battery type: 800 mAh/3,7 V = batteries included = special function: hand motion control, quick switch OFF, battery protection = accessories: USB-C cable = dimensions: 52 × 29 × 35 mm = weight: 56 g = packaging: 1 pc, small paper box



**P3545** 1/-/6/36  
14 41 371 900 P3545

source of light: 7× LED = maximal light output: 550 lm = maximal beam distance: 110 m = number of lighting modes: 7 = runtime: 3.5-9 hrs = reflective head strap = impact resistance = waterproof: yes (IP45) = charging = power supply: Li-pol / 3×AAA = battery type: 1 000 mAh (3,7 V) / LR03 (1,5 V) = batteries included: yes (Li-pol) = special function: quick switch ON/OFF, battery protection = accessories: USB-C cable = dimensions: 64 × 48 × 32 mm = weight: 77 g = packaging: 1 pc, small paper box



**P3546** 1/-/6/36  
14 41 381 900 P3546

# EMOS

## LED Work Lights

### LED Rechargeable Work Lights

- with quality SMD/COB LED chips, lights the whole workspace
- adjustable body and numerous magnets and hooks for easy work
- reinforced ABS plastic – withstands most impacts and falls
- selected models are equipped with a powerbank function

- source of light: COB LED + LED
- maximal light output: 500 lm
- maximal beam distance: 30 m
- number of lighting modes: 3
- runtime: 2.5–6 hrs
- impact resistance
- waterproof: yes (IP54)
- rechargeable
- battery: Li-Ion

- battery type: 2 000 mAh/3.7 V
- batteries included
- recharge time: 3 hrs
- power connector type: USB-C
- features: swivel handle, 1× hook, 1× magnet
- dimensions: 48 × 30 × 207 mm
- weight: 280 g
- packaging: 1 pc, box



**P4546**

1/-/-/18

14 50 000 580

P4546

# EMOS

## LED Night Lights

### LED Battery Night Lights

- better orientation in the dark for both children and adults
- smart solution for places without power (attic or cabinet)
- with switch, photosensor (day/night) or PIR sensor
- very low power consumption

- source of light: LED
- light color: warm white/multicolor
- power source: Li-Ion battery 3.7 V/1,200 mAh
- switch
- automatic on/off
- time delay: 30 minutes
- dimensions: 155 × 85 × 69 mm
- packaging: 1 pc, box



LED    20 lm    3 m

RECHARGEABLE    3 LIGHTING MODES    MULTI COLOUR

8 592920 149614    **P3325**    1/-/6/24  
14 60 000 000    P3325

- source of light: 4× LED
- light color: warm white
- power source: 3× 1.5 V AAA
- switch
- dimensions: 71 × 24 mm
- packaging: 2 pcs, paper blister



LED    15 lm    3 m    Impact resistance    ON/OFF    3× AAA    warm white

8 592920 152508    **P3327**    2/-/10/80  
14 40 043 100    P3327

## LED 230 V Night Lights

- better orientation in the dark for both children and adults
- very low power consumption
- socket-powered – comfortable and eco-friendly (no batteries)
- selected models with USB output
- with switch, photosensor (day/night) or PIR sensor

- source of light: LED
- light color: warm white
- power source: 230 V~/50 Hz
- switch
- dimensions: 63 × 63 × 65 mm
- packaging: 1 pc, paper blister



**P3326** 1/-/5/20  
14 56 000 210 P3326

## EMOS

### LED Flashlights display box

- ready to use (battery included)
- always at hand: in pocket, bag or car
- batteries included
- compact size

- source of light: 4× LED
- light color: warm white
- power source: 3× 1.5 V AAA (included)
- switch
- dimensions: 79 × 26 mm
- packaging: 10 pcs, display box



warm white



**P4722** 10/-/10/40  
14 40 033 104 P4722



www.emos.eu

Order Code  
Item Number

Packaging  
Type

- source of light: COB LED
- maximal light output: 100 lm
- maximal beam distance: 20 m
- number of lighting modes: 3
- runtime: 4-8 hrs
- impact resistance
- waterproof: no
- rechargeable
- battery: Li-pol
- battery type: 200 mAh/3,7 V
- batteries included
- recharge time: 1.5 h
- power connector type: USB C
- features: pendant for hanging
- dimensions: 56 × 26 × 10 mm
- weight: 22 g
- packaging: 12 pcs, display box



**P4724** 12/-/12/48  
14 50 000 570 P4724

## LED Keychains display box

- cute LED keychains for children
- different designs and motives
- selected models also make a sound when lit up
- powered by button batteries (included)

- source of light: LED
- maximal light output: 5 lm
- number of lighting modes: 4
- impact resistance: no
- waterproof: no
- rechargeable: no
- battery: 3× 1,5 V LR43
- battery type: LR43 (1,5 V)
- batteries included
- packaging: 12 pcs, display box



**P4723** 12/-/12/48  
14 39 013 903 P4723W/P4723B/  
P4723P

# Lighting



## Light sources

### LED bulbs

#### Classic

- energy-saving LED bulbs with long lifespan
- an ideal choice with excellent price-to-performance ratio
- provides stable, flicker-free light for better focus at work
- offers pleasant lighting that is gentle on the eyes
- available in a wide range of types and shapes
- using: lighting for modern interiors, households, and offices

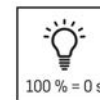
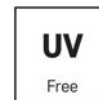

- replacement of incandescent bulb: 39 W
- shape: MR16
- luminous flux: 450 lm
- color temperature: 6 500 K
- power: 4 W
- luminous efficacy: 113 lm/W
- energy efficiency class: E
- beam angle: 100°
- color rendering index (CRI): Ra >80
- voltage: 220-240 V~
- dimensions: 50 × 50 × 58 mm
- packaging: 1 pc, small box



**ZQ8E24** 1/-/10/60  
15 25 730 118 ZQ8E24

- replacement of incandescent bulb: 16 W
- shape: MR16
- luminous flux: 150 lm
- color temperature: 6 500 K
- power: 1.3 W
- luminous efficacy: 115 lm/W
- energy efficiency class: E
- beam angle: 100°
- color rendering index (CRI): Ra >80
- voltage: 220-240 V~
- dimensions: 50 × 50 × 58 mm
- packaging: 1 pc, small box



**ZQ8EL4** 1/-/10/60  
15 25 730 119 ZQ8EL4

- replacement of incandescent bulb: 72 W
- shape: MR16
- luminous flux: 1 000 lm
- color temperature: 6 500 K
- power: 7 W
- luminous efficacy: 143 lm/W
- energy efficiency class: D
- beam angle: 100°
- color rendering index (CRI): Ra >80

- voltage: 220-240 V~
- dimensions: 50 × 50 × 58 mm
- packaging: 1 pc, small box



**ZQ8D64** 1/-/10/60  
15 25 730 120 ZQ8D64

- replacement of incandescent bulb: 75 W
- shape: MR16
- luminous flux: 565 lm
- color temperature: 6 500 K
- power: 5.8 W
- luminous efficacy: 115 lm/W
- energy efficiency class: E
- beam angle: 36°
- color rendering index (CRI): Ra >80

- voltage: 220-240 V~
- dimensions: 50 × 50 × 56 mm
- packaging: 1 pc, small box



**ZQ8E34N** 1/-/10/60  
15 25 730 121 ZQ8E34N

- replacement of incandescent bulb: 16 W
- shape: MR16
- luminous flux: 150 lm
- color temperature: 3 000 K
- power: 1.3 W
- luminous efficacy: 115 lm/W
- energy efficiency class: E
- beam angle: 100°
- color rendering index (CRI): Ra >80

- voltage: 220-240 V~
- dimensions: 50 × 50 × 58 mm
- packaging: 1 pc, small box



**ZQ8EL2** 1/-/10/60  
15 25 730 237 ZQ8EL2

- replacement of incandescent bulb: 72 W
- shape: MR16
- luminous flux: 1 000 lm
- color temperature: 3 000 K
- power: 7 W
- luminous efficacy: 143 lm/W
- energy efficiency class: D
- beam angle: 100°
- color rendering index (CRI): Ra >80

- voltage: 220-240 V~
- dimensions: 50 × 50 × 58 mm
- packaging: 1 pc, small box



**ZQ8D62** 1/-/10/60  
15 25 730 238 ZQ8D62

- replacement of incandescent bulb: 75 W
- shape: MR16
- luminous flux: 565 lm
- color temperature: 3 000 K
- power: 5.8 W
- luminous efficacy: 115 lm/W
- energy efficiency class: E
- beam angle: 36°
- color rendering index (CRI): Ra >80

- voltage: 220-240 V~
- dimensions: 50 × 50 × 56 mm
- packaging: 1 pc, small box



**ZQ8E32N** 1/-/10/60  
15 25 730 239 ZQ8E32N

- replacement of incandescent bulb: 16 W
- shape: MR16
- luminous flux: 150 lm
- color temperature: 4 000 K
- power: 1.3 W
- luminous efficacy: 115 lm/W
- energy efficiency class: E
- beam angle: 100°
- color rendering index (CRI): Ra >80

- voltage: 220-240 V~
- dimensions: 50 × 50 × 58 mm
- packaging: 1 pc, small box



**ZQ8EL3** 1/-/10/60  
15 25 730 434 ZQ8EL3

- replacement of incandescent bulb: 72 W
- shape: MR16
- luminous flux: 1 000 lm
- color temperature: 4 000 K
- power: 7 W
- luminous efficacy: 143 lm/W
- energy efficiency class: D
- beam angle: 100°
- color rendering index (CRI): Ra >80

- voltage: 220-240 V~
- dimensions: 50 × 50 × 58 mm
- packaging: 1 pc, small box



**ZQ8D63** 1/-/10/60  
15 25 730 435 ZQ8D63

- replacement of incandescent bulb: 25 W
- shape: Candle
- luminous flux: 250 lm
- color temperature: 2 700 K
- power: 2.2 W
- luminous efficacy: 114 lm/W
- energy efficiency class: E
- beam angle: 240°
- color rendering index (CRI): Ra >80

- voltage: 220-240 V~
- dimensions: 37 × 37 × 93 mm
- packaging: 1 pc, small box



**ZQ3E01** 1/-/10/40  
15 25 731 438 ZQ3E01

- replacement of incandescent bulb: 25 W
- shape: Candle
- luminous flux: 250 lm
- color temperature: 4 000 K
- power: 2.2 W
- luminous efficacy: 114 lm/W
- energy efficiency class: E
- beam angle: 240°
- color rendering index (CRI): Ra >80

- voltage: 220-240 V~
- dimensions: 37 × 37 × 93 mm
- packaging: 1 pc, small box



**ZQ3E03** 1/-/10/40  
15 25 731 459 ZQ3E03

- replacement of incandescent bulb: 120 W
- shape: Classic A60
- luminous flux: 1 901 lm
- color temperature: 6 500 K
- power: 14 W
- luminous efficacy: 136 lm/W
- energy efficiency class: D
- beam angle: 180°
- color rendering index (CRI): Ra >80

- voltage: 220-240 V~
- dimensions: 60 × 60 × 120 mm
- packaging: 1 pc, small box



**ZQ5D77** 1/-/10/20  
15 25 733 128 ZQ5D77

- = replacement of incandescent bulb: 120 W
- = shape: Classic A60
- = luminous flux: 1 901 lm
- = color temperature: 4 000 K
- = power: 14 W
- = luminous efficacy: 136 lm/W
- = energy efficiency class: D
- = beam angle: 180°
- = color rendering index (CRI): Ra >80

- = voltage: 220-240 V~
- = dimensions: 60 × 60 × 120 mm
- = packaging: 1 pc, small box



**QZ5D76** 1/-/10/20  
15 25 733 501 QZ5D76

- = replacement of incandescent bulb: 120 W
- = shape: Classic A60
- = luminous flux: 1 901 lm
- = color temperature: 2 700 K
- = power: 14 W
- = luminous efficacy: 136 lm/W
- = energy efficiency class: D
- = beam angle: 180°
- = color rendering index (CRI): Ra >80

- = voltage: 220-240 V~
- = dimensions: 60 × 60 × 120 mm
- = packaging: 1 pc, small box



**QZ5D75** 1/-/10/20  
15 25 733 502 QZ5D75

- = replacement of incandescent bulb: 32 W
- = shape: JC
- = luminous flux: 350 lm
- = color temperature: 6 500 K
- = power: 2.5 W
- = luminous efficacy: 140 lm/W
- = energy efficiency class: D
- = beam angle: 300°
- = color rendering index (CRI): Ra >80

- = voltage: 220-240 V~
- = dimensions: 14 × 14 × 43 mm
- = packaging: 1 pc, small box



**QZ9D14** 1/-/10/80  
15 25 736 101 QZ9D14

- = replacement of incandescent bulb: 40 W
- = shape: JC
- = luminous flux: 470 lm
- = color temperature: 6 500 K
- = power: 4.2 W
- = luminous efficacy: 112 lm/W
- = energy efficiency class: E
- = beam angle: 300°
- = color rendering index (CRI): Ra >80

- = voltage: 220-240 V~
- = dimensions: 18 × 18 × 49 mm
- = packaging: 1 pc, small box

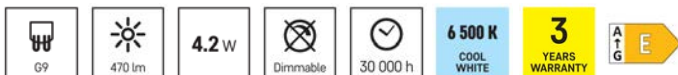

**QZ9E24** 1/-/10/80  
15 25 736 102 QZ9E24

- = replacement of incandescent bulb: 40 W
- = shape: JC
- = luminous flux: 470 lm
- = color temperature: 6 500 K
- = power: 4.2 W
- = luminous efficacy: 112 lm/W
- = energy efficiency class: E
- = beam angle: 300°
- = color rendering index (CRI): Ra >80

- = voltage: 220-240 V~
- = dimensions: 18 × 18 × 49 mm
- = packaging: 2 pcs, small box



**QZ9E24.2** 2/-/20/160  
15 25 736 103 QZ9E24.2



www.emos.eu

Order Code  
Item Number

Packaging  
Type

- = replacement of incandescent bulb: 32 W
- = shape: JC
- = luminous flux: 350 lm
- = color temperature: 3 000 K
- = power: 2.5 W
- = luminous efficacy: 140 lm/W
- = energy efficiency class: D
- = beam angle: 300°
- = color rendering index (CRI): Ra >80

- = voltage: 220-240 V~
- = dimensions: 14 × 14 × 43 mm
- = packaging: 1 pc, small box



**ZQ9D12** 1/-/10/80  
15 25 736 213 ZQ9D12

- = replacement of incandescent bulb: 40 W
- = shape: JC
- = luminous flux: 470 lm
- = color temperature: 3 000 K
- = power: 4.2 W
- = luminous efficacy: 112 lm/W
- = energy efficiency class: E
- = beam angle: 300°
- = color rendering index (CRI): Ra >80

- = voltage: 220-240 V~
- = dimensions: 18 × 18 × 49 mm
- = packaging: 1 pc, small box



**ZQ9E22** 1/-/10/80  
15 25 736 214 ZQ9E22

- = replacement of incandescent bulb: 40 W
- = shape: JC
- = luminous flux: 470 lm
- = color temperature: 3 000 K
- = power: 4.2 W
- = luminous efficacy: 112 lm/W
- = energy efficiency class: E
- = beam angle: 300°
- = color rendering index (CRI): Ra >80

- = voltage: 220-240 V~
- = dimensions: 18 × 18 × 49 mm
- = packaging: 2 pcs, small box



**ZQ9E22.2** 2/-/20/160  
15 25 736 215 ZQ9E22.2

- = replacement of incandescent bulb: 32 W
- = shape: JC
- = luminous flux: 350 lm
- = color temperature: 4 000 K
- = power: 2.5 W
- = luminous efficacy: 140 lm/W
- = energy efficiency class: D
- = beam angle: 300°
- = color rendering index (CRI): Ra >80

- = voltage: 220-240 V~
- = dimensions: 14 × 14 × 43 mm
- = packaging: 1 pc, small box



**ZQ9D13** 1/-/10/80  
15 25 736 413 ZQ9D13

- = replacement of incandescent bulb: 40 W
- = shape: JC
- = luminous flux: 470 lm
- = color temperature: 4 000 K
- = power: 4.2 W
- = luminous efficacy: 112 lm/W
- = energy efficiency class: E
- = beam angle: 300°
- = color rendering index (CRI): Ra >80

- = voltage: 220-240 V~
- = dimensions: 18 × 18 × 49 mm
- = packaging: 1 pc, small box



**ZQ9E23** 1/-/10/80  
15 25 736 414 ZQ9E23



www.emos.eu

Order Code  
Item Number

Packaging  
Type

- = replacement of incandescent bulb: 40 W
- = shape: JC
- = luminous flux: 470 lm
- = color temperature: 4 000 K
- = power: 4.2 W
- = luminous efficacy: 112 lm/W
- = energy efficiency class: E
- = beam angle: 300°
- = color rendering index (CRI): Ra >80

- = voltage: 220-240 V~
- = dimensions: 18 × 18 × 49 mm
- = packaging: 2 pcs, small box



**ZQ9E23.2** 2/-/20/160  
15 25 736 415 ZQ9E23.2

- = replacement of incandescent bulb: 48 W
- = shape: JC
- = luminous flux: 600 lm
- = color temperature: 3 000 K
- = power: 4,3 W
- = luminous efficacy: 140 lm/W
- = energy efficiency class: D
- = beam angle: 300°
- = color rendering index (CRI): Ra >80

- = voltage: 220-240 V~
- = dimensions: 18 × 18 × 60 mm
- = packaging: 1 pc, small box



**ZQ9D32** 1/-/10/80  
15 25 766 201 ZQ9D32

- = replacement of incandescent bulb: 48 W
- = shape: JC
- = luminous flux: 600 lm
- = color temperature: 4 000 K
- = power: 4,3 W
- = luminous efficacy: 140 lm/W
- = energy efficiency class: D
- = beam angle: 300°
- = color rendering index (CRI): Ra >80

- = voltage: 220-240 V~
- = dimensions: 18 × 18 × 60 mm
- = packaging: 1 pc, small box



**ZQ9D33** 1/-/10/80  
15 25 766 202 ZQ9D33

- = replacement of incandescent bulb: 48 W
- = shape: JC
- = luminous flux: 600 lm
- = color temperature: 6 500 K
- = power: 4,3 W
- = luminous efficacy: 140 lm/W
- = energy efficiency class: D
- = beam angle: 300°
- = color rendering index (CRI): Ra >80

- = voltage: 220-240 V~
- = dimensions: 18 × 18 × 60 mm
- = packaging: 1 pc, small box

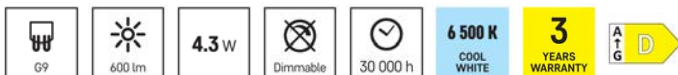

**ZQ9D34** 1/-/10/80  
15 25 766 203 ZQ9D34

- = replacement of incandescent bulb: 60 W
- = shape: JC
- = luminous flux: 806 lm
- = color temperature: 3 000 K
- = power: 4,9 W
- = luminous efficacy: 164 lm/W
- = energy efficiency class: C
- = beam angle: 300°
- = color rendering index (CRI): Ra >80

- = voltage: 230 V~/50 Hz
- = dimensions: 18 × 18 × 60 mm
- = packaging: 1 pc, small box



**ZQ9C42** 1/-/10/80  
15 25 766 204 ZQ9C42



www.emos.eu

Order Code  
Item Number

Packaging  
Type

- replacement of incandescent bulb: 60 W
- shape: JC
- luminous flux: 806 lm
- color temperature: 4 000 K
- power: 4,9 W
- luminous efficacy: 164 lm/W
- energy efficiency class: C
- beam angle: 300°
- color rendering index (CRI): Ra >80
- voltage: 230 V~/50 Hz
- dimensions: 18 × 18 × 60 mm
- packaging: 1 pc, small box



**ZQ9C43** 1/-/10/80  
15 25 766 205 ZQ9C43

- replacement of incandescent bulb: 60 W
- shape: JC
- luminous flux: 806 lm
- color temperature: 6 500 K
- power: 4,9 W
- luminous efficacy: 164 lm/W
- energy efficiency class: C
- beam angle: 300°
- color rendering index (CRI): Ra >80
- voltage: 230 V~/50 Hz
- dimensions: 18 × 18 × 60 mm
- packaging: 1 pc, small box



**ZQ9C44** 1/-/10/80  
15 25 766 206 ZQ9C44

## Basic

- lighting solution with optimal quality at the best price
- maximum lighting efficiency with minimal energy use
- perfect replacement for traditional tungsten filament bulbs
- available in a wide range of types and shapes
- using: lighting for modern interiors, households, and offices



- replacement of incandescent bulb: 72 W
- shape: MR16
- luminous flux: 1 000 lm
- color temperature: 6 500 K
- power: 10 W
- luminous efficacy: 100 lm/W
- energy efficiency class: F
- beam angle: 110°
- color rendering index (CRI): Ra >80
- voltage: 220-240 V~
- dimensions: 50 × 50 × 58 mm
- packaging: 1 pc, small box



**ZL8F54** 1/-/10/90  
15 25 730 117 ZL8F54

- replacement of incandescent bulb: 72 W
- shape: MR16
- luminous flux: 1 000 lm
- color temperature: 3 000 K
- power: 10 W
- luminous efficacy: 100 lm/W
- energy efficiency class: F
- beam angle: 110°
- color rendering index (CRI): Ra >80
- voltage: 220-240 V~
- dimensions: 50 × 50 × 58 mm
- packaging: 1 pc, small box



**ZL8F52** 1/-/10/90  
15 25 730 236 ZL8F52

- replacement of incandescent bulb: 72 W
- shape: MR16
- luminous flux: 1 000 lm
- color temperature: 4 000 K
- power: 10 W
- luminous efficacy: 100 lm/W
- energy efficiency class: F
- beam angle: 110°
- color rendering index (CRI): Ra >80

- voltage: 220-240 V~
- dimensions: 50 × 50 × 58 mm
- packaging: 1 pc, small box



**ZL8F53** 1/-/10/90  
15 25 730 433 ZL8F53

## Light sources

### ECO halogen

- energy-saving replacement for halogen reflector lights
- excellent luminous efficacy, energy saving and long lifespan
- selected models with dimming capability
- using: lighting for indoor and outdoor spaces

- replacement of incandescent bulb: 22 W
- dimmable
- shape: JC
- luminous flux: 220 lm
- color temperature: 2 700 K
- power: 14 W
- luminous efficacy: 11 lm/W
- energy efficiency class: G
- beam angle: 270°

- color rendering index (CRI): 99.9
- voltage: 12 V
- dimensions: 33 × 9 × 9 mm
- packaging: 1 pc, small box



**ZE0505A** 1/10/100/800  
15 28 001 402 ZE0505A

- replacement of incandescent bulb: 26 W
- dimmable
- shape: JC
- luminous flux: 260 lm
- color temperature: 2 700 K
- power: 25 W
- luminous efficacy: 10 lm/W
- energy efficiency class: G
- beam angle: 270°

- color rendering index (CRI): 99.9
- voltage: 230 V~/50 Hz
- dimensions: 40 × 14 × 14 mm
- packaging: 1 pc, small box



**ZE0304** 1/10/100/800  
15 28 020 000 ZE0304

**EMOS**

A brand of Legrand

www.emos.eu

Order Code  
Item NumberPackaging  
Type

- replacement of incandescent bulb: 31 W
- dimmable
- shape: JC
- luminous flux: 340 lm
- color temperature: 2 700 K
- power: 30 W
- luminous efficacy: 11 lm/W
- energy efficiency class: G
- beam angle: 270°

- color rendering index (CRI): 99.9
- voltage: 230 V~/50 Hz
- dimensions: 40 × 14 × 14 mm
- packaging: 1 pc, small box



**ZE0305** 1/10/100/800  
15 28 021 000 ZE0305

- replacement of incandescent bulb: 47 W
- dimmable
- shape: JC
- luminous flux: 580 lm
- color temperature: 2 700 K
- power: 42 W
- luminous efficacy: 13 lm/W
- energy efficiency class: G
- beam angle: 270°

- color rendering index (CRI): 99.9
- voltage: 220-240 V~
- dimensions: 40 × 14 × 14 mm
- packaging: 1 pc, small box



**ZE0306** 1/10/100/800  
15 28 022 000 ZE0306

## Light sources

### LED tubes, tubes

#### PROFI PLUS

- designed as a professional replacement for fluorescent tubes
- features excellent luminous efficacy and high energy savings
- offers extended lifespan and 5-year warranty
- using: administrative and industrial spaces

- shape: T8
- luminous flux: 1 100 lm
- color temperature: 4 000 K
- power: 6.5 W
- luminous efficacy: 169 lm/W
- energy efficiency class: C
- beam angle: 250°
- color rendering index (CRI): Ra >80
- voltage: 230 V~/50 Hz

- dimensions: 603 × 27 × 27 mm
- packaging: 10 pcs, small box



**Z73217** 10/-/-/10  
15 35 253 000 Z73217

- shape: T8
- luminous flux: 1 100 lm
- color temperature: 6 500 K
- power: 6.5 W
- luminous efficacy: 169 lm/W
- energy efficiency class: C
- beam angle: 250°
- color rendering index (CRI): Ra >80
- voltage: 230 V~/50 Hz

- dimensions: 603 × 27 × 27 mm
- packaging: 10 pcs, small box

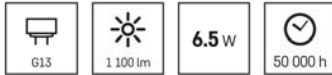

**Z73218** 10/-/-/10  
15 35 254 000 Z73218

- shape: T8
- luminous flux: 2 550 lm
- color temperature: 4 000 K
- power: 15 W
- luminous efficacy: 170 lm/W
- energy efficiency class: C
- beam angle: 250°
- color rendering index (CRI): Ra >80
- voltage: 230 V~/50 Hz

- dimensions: 1 213 × 27 × 27 mm
- packaging: 10 pcs, small box

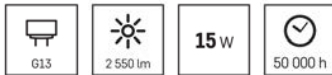

**Z73227** 10/-/-/10  
15 35 255 000 Z73227

- shape: T8
- luminous flux: 2 550 lm
- color temperature: 6 500 K
- power: 15 W
- luminous efficacy: 170 lm/W
- energy efficiency class: C
- beam angle: 250°
- color rendering index (CRI): Ra >80
- voltage: 230 V~/50 Hz

- dimensions: 1 213 × 27 × 27 mm
- packaging: 10 pcs, small box



**Z73228** 10/-/-/10  
15 35 256 000 Z73228

- shape: T8
- luminous flux: 4 050 lm
- color temperature: 4 000 K
- power: 24 W
- luminous efficacy: 169 lm/W
- energy efficiency class: C
- beam angle: 250°
- color rendering index (CRI): Ra >80
- voltage: 230 V~/50 Hz

- dimensions: 1 514 × 27 × 27 mm
- packaging: 10 pcs, small box



**Z73237** 10/-/-/10  
15 35 257 000 Z73237

- shape: T8
- luminous flux: 4 050 lm
- color temperature: 6 500 K
- power: 24 W
- luminous efficacy: 169 lm/W
- energy efficiency class: C
- beam angle: 250°
- color rendering index (CRI): Ra >80
- voltage: 230 V~/50 Hz

- dimensions: 1 514 × 27 × 27 mm
- packaging: 10 pcs, small box



**Z73238** 10/-/-/10  
15 35 258 000 Z73238

# Light sources

---

## Car-light bulbs

- premium OSRAM LED car bulbs for front headlights
- available in various socket types for every driver
- up to 150% brighter light than the minimum legal requirement
- up to 150 m longer beam distance than competing brands
- 20% whiter light for better visibility and a more stylish look

---

**C3101.2**

2/-/-/10

31 32 310 120

C3101.2



4 062 172 3876 13



- international marking: H7
- use for: main headlight
- packaging: 1 pc, small box

# Luminaires

## Floodlights

### CLASSIC

## TAMBO

## CLASSIC

- offers an ultra-slim design and complete reliability
- milky PC diffuser ensures pleasantly diffused light
- angled mounting bracket allow easy and secure installation
- selected models with adjustable PIR sensor and twilight sensor
- IP54 protection guarantees resistance to water and dust
- operating cost savings of up to 70% vs. halogen floodlights
- 3 years warranty
- using: basic applications in commercial and private spaces

- power: 10 W
- luminous flux: 1 000 lm
- color temperature: 4 000 K
- light color: neutral white
- color rendering index (CRI): Ra > 80
- voltage: 220–240 V~
- IP rating: IP65
- beam angle: 110°
- dimensions: 105 × 71 × 36 mm

- supply cable length: 30 cm
- lead-in cable material: rubber
- lead-in cable type: 3G1.0 mm<sup>2</sup>
- body material: aluminum
- mechanical impact protection: IK07
- packaging: 1 pc, box

**ZS2514**

1/-/-14

15 31 291 000

ZS2514



- power: 10 W
- luminous flux: 1 000 lm
- color temperature: 4 000 K
- light color: neutral white
- color rendering index (CRI): Ra > 80
- voltage: 220–240 V~
- IP rating: IP44
- beam angle: 110°
- dimensions: 105 × 116 × 39 mm

- supply cable length: 30 cm
- lead-in cable material: rubber
- lead-in cable type: 3G1.0 mm<sup>2</sup>
- body material: aluminum
- mechanical impact protection: IK07
- packaging: 1 pc, box

**ZS2914**

1/-/-14

15 31 291 010

ZS2914



- power: 20 W
- luminous flux: 2 000 lm
- color temperature: 4 000 K
- light color: neutral white
- color rendering index (CRI): Ra > 80
- voltage: 220–240 V~
- IP rating: IP65
- beam angle: 110°
- dimensions: 126 × 96 × 38 mm

- supply cable length: 30 cm
- lead-in cable material: rubber
- lead-in cable type: 3G1.0 mm<sup>2</sup>
- body material: aluminum
- mechanical impact protection: IK07
- packaging: 1 pc, box

**ZS2524**

1/-/-12

15 31 292 000

ZS2524



- power: 20 W
- luminous flux: 2 000 lm
- color temperature: 4 000 K
- light color: neutral white
- color rendering index (CRI): Ra > 80
- voltage: 220–240 V~
- IP rating: IP44
- beam angle: 110°
- dimensions: 126 × 138 × 39 mm

- supply cable length: 30 cm
- lead-in cable material: rubber
- lead-in cable type: 3G1.0 mm<sup>2</sup>
- body material: aluminum
- mechanical impact protection: IK07
- packaging: 1 pc, box



**ZS2924** 1/-/-12  
15 31 292 020 ZS2924

- power: 30 W
- luminous flux: 3 000 lm
- color temperature: 4 000 K
- light color: neutral white
- color rendering index (CRI): Ra > 80
- voltage: 220–240 V~
- IP rating: IP65
- beam angle: 110°
- dimensions: 155 × 130 × 39 mm

- supply cable length: 30 cm
- lead-in cable material: rubber
- lead-in cable type: 3G1.0 mm<sup>2</sup>
- body material: aluminum
- mechanical impact protection: IK07
- packaging: 1 pc, box



**ZS2534** 1/-/-10  
15 31 293 000 ZS2534

- power: 30 W
- luminous flux: 3 000 lm
- color temperature: 4 000 K
- light color: neutral white
- color rendering index (CRI): Ra > 80
- voltage: 220–240 V~
- IP rating: IP44
- beam angle: 110°
- dimensions: 155 × 172 × 39 mm

- supply cable length: 30 cm
- lead-in cable material: rubber
- lead-in cable type: 3G1.0 mm<sup>2</sup>
- body material: aluminum
- mechanical impact protection: IK07
- packaging: 1 pc, box



**ZS2934** 1/-/-10  
15 31 293 030 ZS2934

- power: 50 W
- luminous flux: 5 000 lm
- color temperature: 4 000 K
- light color: neutral white
- color rendering index (CRI): Ra > 80
- voltage: 220–240 V~
- IP rating: IP65
- beam angle: 110°
- dimensions: 190 × 148 × 39 mm

- supply cable length: 30 cm
- lead-in cable material: rubber
- lead-in cable type: 3G1.0 mm<sup>2</sup>
- body material: aluminum
- mechanical impact protection: IK07
- packaging: 1 pc, box



**ZS2544** 1/-/-7  
15 31 295 000 ZS2544

- power: 50 W
- luminous flux: 5 000 lm
- color temperature: 4 000 K
- light color: neutral white
- color rendering index (CRI): Ra > 80
- voltage: 220–240 V~
- IP rating: IP44
- beam angle: 110°
- dimensions: 190 × 191 × 39 mm

- supply cable length: 30 cm
- lead-in cable material: rubber
- lead-in cable type: 3G1.0 mm<sup>2</sup>
- body material: aluminum
- mechanical impact protection: IK07
- packaging: 1 pc, box



**ZS2944** 1/-/-7  
15 31 295 050 ZS2944

**EMOS**A brand of 

www.emos.eu

Order Code  
Item NumberPackaging  
Type

- power: 100 W
- luminous flux: 10 000 lm
- color temperature: 4 000 K
- light color: neutral white
- color rendering index (CRI): Ra > 80
- voltage: 220–240 V~
- IP rating: IP65
- beam angle: 110°
- dimensions: 275 × 219 × 41 mm
- supply cable length: 30 cm
- lead-in cable material: rubber
- lead-in cable type: 3G1.0 mm<sup>2</sup>
- body material: aluminum
- mechanical impact protection: IK07
- packaging: 1 pc, box

**ZS2554**

1/-/-7

15 31 296 000

ZS2554

## Luminaires

## Work Lights

## PROFI

### ELION

- floodlights with battery offer maximum variability
- robust design suitable for working in harsh environments
- no need for a nearby power socket
- folding stand for easy transport and storage
- IP54 rating ensures water resistance
- 120° lighting angle
- 3 years warranty
- use: construction, garage, workshop, car repair shop, camping

- power: 20 W
- luminous flux: 3 000 lm
- color temperature: 4 000 K
- light color: neutral white
- color rendering index (CRI): Ra > 80
- voltage: 220–240 V~
- IP rating: IP65/IP44
- beam angle: 110°
- dimensions: 212 × 143 × 248 mm
- supply cable length: 1.5 m
- lead-in cable material: rubber
- lead-in cable type: H05RN-F
- body material: aluminum
- mechanical impact protection: IK07
- packaging: 1 pc, box

**ZS3323**

1/-/-6

15 31 251 011

ZS3323

- power: 30 W
- luminous flux: 4 800 lm
- color temperature: 4 000 K
- light color: neutral white
- color rendering index (CRI): Ra > 80
- voltage: 220–240 V~
- IP rating: IP65/IP44
- beam angle: 110°
- dimensions: 252 × 280 × 169 mm
- supply cable length: 1.5 m
- lead-in cable material: rubber
- lead-in cable type: H05RN-F
- body material: aluminum
- mechanical impact protection: IK07
- packaging: 1 pc, box

**ZS3333**

1/-/-4

15 31 251 021

ZS3333



www.emos.eu

Order Code  
Item Number

Packaging  
Type

- power: 50 W
- luminous flux: 8 000 lm
- color temperature: 4 000 K
- light color: neutral white
- color rendering index (CRI): Ra > 80
- voltage: 220-240 V~
- IP rating: IP65/IP44
- beam angle: 110°
- dimensions: 281 × 182 × 297 mm

- supply cable length: 1.5 m
- lead-in cable material: rubber
- lead-in cable type: H05RN-F
- body material: aluminum
- mechanical impact protection: IK07
- packaging: 1 pc, box



**ZS3343** 1/-/-/4  
15 31 251 031 ZS3343

- power: 100 W
- luminous flux: 16 000 lm
- color temperature: 4 000 K
- light color: neutral white
- color rendering index (CRI): Ra > 80
- voltage: 220-240 V~
- IP rating: IP65/IP44
- beam angle: 110°
- dimensions: 398 × 349 × 247 mm

- supply cable length: 1.5 m
- lead-in cable material: rubber
- lead-in cable type: H05RN-F
- body material: aluminum
- mechanical impact protection: IK07
- packaging: 1 pc, box



**ZS3353** 1/-/-/2  
15 31 251 041 ZS3353

- power: 2× 30 W
- luminous flux: 2× 4 800 lm
- color temperature: 4 000 K
- light color: neutral white
- color rendering index (CRI): Ra > 80
- voltage: 220-240 V~
- IP rating: IP65/IP44
- beam angle: 110°
- dimensions: 1 153 × 1 075 × 1 686 mm

- supply cable length: 3 m
- lead-in cable material: rubber
- lead-in cable type: H05RN-F 3G1.0 mm<sup>2</sup>
- body material: aluminum
- mechanical impact protection: IK08
- packaging: 1 pc, box



**ZS3333.2** 1/-/-/2  
15 31 251 051 ZS3333.2

- power: 2× 50 W
- luminous flux: 2× 8 000 lm
- color temperature: 4 000 K
- light color: neutral white
- color rendering index (CRI): Ra > 80
- voltage: 220-240 V~
- IP rating: IP65/IP44
- beam angle: 110°
- dimensions: 1 153 × 1 075 × 1 705 mm

- supply cable length: 3 m
- lead-in cable material: rubber
- lead-in cable type: H07RN-F
- body material: aluminum
- mechanical impact protection: IK08
- packaging: 1 pc, box



**ZS3343.2** 1/-/-/2  
15 31 251 061 ZS3343.2

# Luminaires

## Work Lights

### CLASSIC

#### ACCO

#### CLASSIC

- offer greater flexibility thanks to the integrated battery
- do not require connection to the power grid
- robust design for demanding environments
- practical stand allows better adjustment of the light direction
- IP54 guarantees resistance to water and dust
- 3 years warranty
- using: lighting of workplaces, in garages, workshops, car services

- power: 20 W
- luminous flux: 1 650 lm
- color temperature: 6 500 K
- light color: cool white
- color rendering index (CRI): Ra > 80
- voltage: 5 V DC
- IP rating: IP54
- beam angle: 120°
- dimensions: 212 × 177 × 227 mm

- battery: Li-Ion 5 000 mAh
- AKU lighting time: 3 – 12 hours
- lead-in cable type: USB C
- body material: aluminum
- mechanical impact protection: IK05
- packaging: 1 pc, box

**ZS2813**

15 42 032 000

1/-/-/5

ZS2813

- power: 35 W
- luminous flux: 3 300 lm
- color temperature: 6 500 K
- light color: cool white
- color rendering index (CRI): Ra > 80
- voltage: 5 V DC
- IP rating: IP54
- beam angle: 120°
- dimensions: 266 × 220 × 276 mm

- battery: Li-Ion 10 000 mAh
- AKU lighting time: 3 – 12 hours
- lead-in cable type: USB C
- body material: aluminum
- mechanical impact protection: IK05
- packaging: 1 pc, box

**ZS2823**

15 42 033 000

1/-/-/4

ZS2823

- power: 50 W
- luminous flux: 4 950 lm
- color temperature: 6 500 K
- light color: cool white
- color rendering index (CRI): Ra > 80
- voltage: 5 V DC
- IP rating: IP54
- beam angle: 120°
- dimensions: 292 × 219 × 276 mm

- battery: Li-Ion 15 000 mAh
- AKU lighting time: 3 – 12 hours
- lead-in cable type: USB C
- body material: aluminum
- mechanical impact protection: IK05
- packaging: 1 pc, box

**ZS2833**

15 42 035 000

1/-/-/2

ZS2833

# Luminaires

## Work Lights

### ESSENTIAL

#### GLARO

- IP65/44 rating for max. performance in demanding environments
- portability provides high flexibility for all models
- adjustable light direction
- durable metal construction
- foldable for transport and storage
- applications: construction sites, workshops, car service areas

- power: 30 W
- luminous flux: 3 000 lm
- color temperature: 4 000 K
- light color: neutral white
- color rendering index (CRI): Ra > 80
- voltage: 220–240 V~
- IP rating: IP65/IP44
- beam angle: 120°
- dimensions: 215 × 57 × 229 mm



- supply cable length: 1.5 m
- lead-in cable material: rubber
- lead-in cable type: H05RN-F
- body material: aluminum
- mechanical impact protection: IK08
- packaging: 1 pc, box



**ZS3213** 1/-/-/8  
15 31 223 500 ZS3213

- power: 50 W
- luminous flux: 5 000 lm
- color temperature: 4 000 K
- light color: neutral white
- color rendering index (CRI): Ra > 80
- voltage: 220–240 V~
- IP rating: IP65/IP44
- beam angle: 120°
- dimensions: 248 × 59 × 255 mm



- supply cable length: 1.5 m
- lead-in cable material: rubber
- lead-in cable type: H05RN-F
- body material: aluminum
- mechanical impact protection: IK08
- packaging: 1 pc, box



**ZS3214** 1/-/-/8  
15 31 224 500 ZS3214

- power: 100 W
- luminous flux: 10 000 lm
- color temperature: 4 000 K
- light color: neutral white
- color rendering index (CRI): Ra > 80
- voltage: 220–240 V~
- IP rating: IP65/IP44
- beam angle: 120°
- dimensions: 297 × 59 × 290 mm



- supply cable length: 1.5 m
- lead-in cable material: rubber
- lead-in cable type: H05RN-F
- body material: aluminum
- mechanical impact protection: IK08
- packaging: 1 pc, box



**ZS3215** 1/-/-/4  
15 31 225 500 ZS3215



www.emos.eu

Order Code  
Item Number

Packaging  
Type

- power: 2× 30 W
- luminous flux: 2× 3 000 lm
- color temperature: 4 000 K
- light color: neutral white
- color rendering index (CRI): Ra > 80
- voltage: 220–240 V~
- IP rating: IP65/IP44
- beam angle: 120°
- dimensions: 732 × 630 × 1 723 mm

- supply cable length: 3 m
- lead-in cable material: rubber
- lead-in cable type: H05RN-F
- body material: aluminum
- mechanical impact protection: IK08
- packaging: 1 pc, box



**ZS3213.2** 1/-/-/2  
15 31 223 502 ZS3213.2

- power: 2× 50 W
- luminous flux: 2× 5 000 lm
- color temperature: 4 000 K
- light color: neutral white
- color rendering index (CRI): Ra > 80
- voltage: 220–240 V~
- IP rating: IP65/IP44
- beam angle: 120°
- dimensions: 732 × 630 × 1 748 mm

- supply cable length: 3 m
- lead-in cable material: rubber
- lead-in cable type: H05RN-F
- body material: aluminum
- mechanical impact protection: IK08
- packaging: 1 pc, box



**ZS3214.2** 1/-/-/2  
15 31 224 502 ZS3214.2

- power: 2× 100 W
- luminous flux: 2× 10 000 lm
- color temperature: 4 000 K
- light color: neutral white
- color rendering index (CRI): Ra > 80
- voltage: 220–240 V~
- IP rating: IP65/IP44
- beam angle: 120°
- dimensions: 732 × 630 × 1 784 mm

- supply cable length: 3 m
- lead-in cable material: rubber
- lead-in cable type: H05RN-F
- body material: aluminum
- mechanical impact protection: IK08
- packaging: 1 pc, box



**ZS3215.2** 1/-/-/2  
15 31 225 402 ZS3215.2

# Luminaires

## LED Panels

### PROFI PLUS

## LUXXO

## PROFI PLUS

- provide an efficient solution for indoor lighting
- available in square or rectangular design
- offer high efficiency with an energy class A light source
- 5-year warranty
- application: offices, classrooms, indoor spaces

- power: 22 W
- replacement of incandescent bulb: 4× 18 W CFL
- luminous flux: 4 000 lm
- color temperature: 4 000 K
- body material: steel plate
- color rendering index (CRI): Ra > 80
- beam angle: 120°
- type of mounting: recessed
- dimensions: 595 × 595 × 32 mm

- body colour: white
- line: LUXXO
- warranty period: 5 years
- UGR<: 22



**ZB2110** 1/-/-/5  
15 44 102 220 ZB2110

- power: 22 W
- replacement of incandescent bulb: 4× 18 W CFL
- luminous flux: 3 800 lm
- color temperature: 4 000 K
- body material: steel plate
- color rendering index (CRI): Ra > 80
- beam angle: 90°
- type of mounting: recessed
- dimensions: 595 × 595 × 32 mm

- body colour: white
- line: LUXXO
- warranty period: 5 years
- UGR<: 19



**ZB2120** 1/-/-/5  
15 44 102 221 ZB2120

- power: 22 W
- replacement of incandescent bulb: 2× 36 W CFL
- luminous flux: 4 000 lm
- color temperature: 4 000 K
- body material: steel plate
- color rendering index (CRI): Ra > 80
- beam angle: 120°
- type of mounting: recessed
- dimensions: 295 × 1 195 × 32 mm

- body colour: white
- line: LUXXO
- warranty period: 5 years
- UGR<: 22



**ZB4110** 1/-/-/5  
15 44 202 220 ZB4110

- power: 22 W
- replacement of incandescent bulb: 4× 18 W CFL
- luminous flux: 3 800 lm
- color temperature: 4 000 K
- body material: steel plate
- color rendering index (CRI): Ra > 80
- beam angle: 90°
- type of mounting: recessed
- dimensions: 295 × 1 195 × 32 mm
- body colour: white
- line: LUX XO
- warranty period: 5 years
- UGR<: 19

4 000 K  
NEUTRAL  
WHITE

8 592920 152935

**ZB4120**

15 44 202 221

1/-/-/5

ZB4120

# Luminaires

## LED Panels

### CLASSIC

## DIX XO

## CLASSIC

- represent an economical option for indoor lighting
- elegant design ideal for classrooms and offices
- combine high efficiency and excellent performance
- 5 years warranty
- using: offices, classrooms, indoor spaces etc.

- power: 36 W
- replacement of incandescent bulb: 4× 18 W CFL
- luminous flux: 4 000 lm
- color temperature: 4 000 K
- body material: steel plate
- color rendering index (CRI): Ra > 80
- beam angle: 120°
- type of mounting: recessed
- dimensions: 595 × 595 × 28 mm
- body colour: white
- line: DIX XO
- warranty period: 5 years
- UGR<: 22

4 000 K  
NEUTRAL  
WHITE

8 592920 149102

**ZB2410**

15 44 103 645

1/-/-/6

ZB2410

# Luminaires

## Surface Luminaires

### EXCLUSIVE

#### ILVI

#### EXCLUSIVE

- luminaires in a circular shape with very economical LED diodes
- they have a timer function and smooth dimming
- allows setting colors and pleasant night lighting
- it illuminates the ceiling above and creates a pleasant halo effect
- 3 years warranty
- using: lighting of interiors in households, office spaces or hotels

- power: 30 W
- replacement of incandescent bulb: 115 W
- luminous flux: 180–1 800 lm
- color temperature: 2 700–6 500 K
- body material: steel plate
- color rendering index (CRI): Ra > 80
- beam angle: 120°
- type of mounting: surface
- dimensions: 400 × 70 mm in diameter

- dimming function
- body colour: white/wood
- line: ILVI
- warranty period: 3 years

**ZM5114**

1/-/-/5

15 39 095 300

ZM5114

- power: 45 W
- replacement of incandescent bulb: 160 W
- luminous flux: 270–2 700 lm
- color temperature: 2 700–6 500 K
- body material: steel plate
- color rendering index (CRI): Ra > 80
- beam angle: 120°
- type of mounting: surface
- dimensions: 500 × 70 mm in diameter

- dimming function
- body colour: white/wood
- line: ILVI
- warranty period: 3 years

**ZM5115**

1/-/-/5

15 39 095 450

ZM5115

- power: 30 W
- replacement of incandescent bulb: 115 W
- luminous flux: 180–1 800 lm
- color temperature: 2 700–6 500 K
- body material: steel plate
- color rendering index (CRI): Ra > 80
- beam angle: 120°
- type of mounting: surface
- dimensions: 400 × 70 mm in diameter

- dimming function
- body colour: black/wood
- line: ILVI
- warranty period: 3 years

**ZM5116**

1/-/-/5

15 39 096 300

ZM5116

- power: 45 W
- replacement of incandescent bulb: 160 W
- luminous flux: 270–2 700 lm
- color temperature: 2 700–6 500 K
- body material: steel plate
- color rendering index (CRI): Ra > 80
- beam angle: 120°
- type of mounting: surface
- dimensions: 500 × 70 mm in diameter

- dimming function
- body colour: black/wood
- line: ILVI
- warranty period: 3 years



**ZM5117** 1/-/-/5  
15 39 096 450 ZM5117

- power: 30 W
- replacement of incandescent bulb: 115 W
- luminous flux: 180–1 800 lm
- color temperature: 2 700–6 500 K
- body material: steel plate
- color rendering index (CRI): Ra > 80
- beam angle: 120°
- type of mounting: surface
- dimensions: 400 × 70 mm in diameter

- dimming function
- body colour: black/champagne
- line: ILVI
- warranty period: 3 years



**ZM5118** 1/-/-/5  
15 39 097 300 ZM5118

- power: 45 W
- replacement of incandescent bulb: 160 W
- luminous flux: 270–2 700 lm
- color temperature: 2 700–6 500 K
- body material: steel plate
- color rendering index (CRI): Ra > 80
- beam angle: 120°
- type of mounting: surface
- dimensions: 500 × 70 mm in diameter

- dimming function
- body colour: black/champagne
- line: ILVI
- warranty period: 3 years



**ZM5119** 1/-/-/5  
15 39 097 450 ZM5119

- power: 30 W
- replacement of incandescent bulb: 115 W
- luminous flux: 180–1 800 lm
- color temperature: 2 700–6 500 K
- body material: steel plate
- color rendering index (CRI): Ra > 80
- beam angle: 120°
- type of mounting: surface
- dimensions: 400 × 70 mm in diameter

- dimming function
- body colour: wood
- line: ILVI
- warranty period: 3 years



**ZM5160** 1/-/-/5  
15 39 098 300 ZM5160

- power: 45 W
- replacement of incandescent bulb: 160 W
- luminous flux: 270–2 700 lm
- color temperature: 2 700–6 500 K
- body material: steel plate
- color rendering index (CRI): Ra > 80
- beam angle: 120°
- type of mounting: surface
- dimensions: 500 × 70 mm in diameter

- dimming function
- body colour: wood
- line: ILVI
- warranty period: 3 years



**ZM5161** 1/-/-/5  
15 39 098 450 ZM5161

## SABI

- control via remote control
- adjustable light intensity and color temperature
- option to save favorite lighting settings for quick scene changes
- timer and night light function
- easy installation
- 3 year warranty

- power: 30 W
- replacement of incandescent bulb: 110 W
- luminous flux: 180–1 800 lm
- color temperature: 2 700–6 500 K
- body material: plastic (PS) + steel plate
- color rendering index (CRI): Ra > 80
- beam angle: 115°
- type of mounting: surface
- dimensions: 400 × 60 mm

- dimming function
- body colour: white
- line: SABI
- warranty period: 3 years

**ZM5111**

1/-/-/5

15 39 087 303

LD-MYRC30-400

- power: 45 W
- replacement of incandescent bulb: 170 W
- luminous flux: 270–2 700 lm
- color temperature: 2 700–6 500 K
- body material: plastic (PS) + steel plate
- color rendering index (CRI): Ra > 80
- beam angle: 115°
- type of mounting: surface
- dimensions: 500 × 70 mm

- dimming function
- body colour: white
- line: SABI
- warranty period: 3 years

**ZM5112**

1/-/-/5

15 39 087 452

LD-MYRC45-500

## REMI

- control via remote control
- adjustable light intensity and color temperature
- option to save favorite lighting settings for quick scene changes
- timer and night light function
- easy installation
- 3 year warranty

- power: 45 W
- replacement of incandescent bulb: 160 W
- luminous flux: 270–2 700 lm
- color temperature: 2 700–6 500 K
- body material: plastic (PS) + steel plate
- color rendering index (CRI): Ra > 80
- beam angle: 115°
- type of mounting: surface
- dimensions: 510 × 70 mm

- dimming function
- body colour: white
- line: REMI
- warranty period: 3 years

**ZM5113**

1/-/-/5

15 39 087 453

LD-PBRC45-510

# Luminaires

## Surface Luminaires

### PROFI

#### TIVI

#### PROFI

- ceiling lamps with a light source of energy class A
- high luminous efficacy and simple design
- IP44 enclosure ensures water resistance
- easy installation
- use: indoor and outdoor environment of premises and houses

- power: 8.6 W
- replacement of incandescent bulb: 90 W
- luminous flux: 1 440 lm
- color temperature: 4 000 K
- body material: steel plate
- color rendering index (CRI): Ra > 80
- motion sensor: MW
- beam angle: 120°
- sensor detection range: 10 m

- type of mounting: surface
- dimensions: 325 × 90 mm in diameter
- body colour: white
- line: TIVI
- warranty period: 5 years

**ZM3406M**

1/-/-2

15 39 085 900

CL06-A17 MW

- power: 12.5 W
- replacement of incandescent bulb: 135 W
- luminous flux: 2 100 lm
- color temperature: 4 000 K
- body material: steel plate
- color rendering index (CRI): Ra > 80
- motion sensor: MW
- beam angle: 120°
- sensor detection range: 10 m

- type of mounting: surface
- dimensions: 380 × 100 mm in diameter
- body colour: white
- line: TIVI
- warranty period: 5 years

**ZM3408M**

1/-/-2

15 39 085 130

CL06-A24 MW

- power: 19 W
- replacement of incandescent bulb: 170 W
- luminous flux: 3 000 lm
- color temperature: 4 000 K
- body material: steel plate
- color rendering index (CRI): Ra > 80
- beam angle: 120°
- type of mounting: surface
- dimensions: 380 × 100 mm in diameter

- body colour: white
- line: TIVI
- warranty period: 5 years

**ZM3409**

1/-/-2

15 39 085 190

CL06-A24

# Luminaires

## Cabinet Luminaires

### CLASSIC

## GLASO

## CLASSIC

- functional accessory for any bathroom
- combines lighting and decorative function
- available in 3 colors – white, black and silver
- neutral white light color
- easy installation – 4 different mounting options
- IP44 rating for damp environments

- power: 6 W
  - length: 300 mm
  - luminous flux: 700 lm
  - color temperature: 4 000 K
  - light color: neutral white
  - material: aluminium (Al)
  - dimensions: 300 × 128 × 38 mm
  - lifetime: 25 000 hours
  - beam angle: 120°
- = packaging: 1 pc, small box



**ZS2160** 1/-/-/6  
15 39 300 621 ZS2160

- power: 10 W
  - length: 500 mm
  - luminous flux: 1 000 lm
  - color temperature: 4 000 K
  - light color: neutral white
  - material: aluminium (Al)
  - dimensions: 500 × 128 × 38 mm
  - lifetime: 25 000 hours
  - beam angle: 120°
- = packaging: 1 pc, small box



**ZS2161** 1/-/-/6  
15 39 301 021 ZS2161

- power: 6 W
  - length: 300 mm
  - luminous flux: 700 lm
  - color temperature: 4 000 K
  - light color: neutral white
  - material: aluminium (Al)
  - dimensions: 300 × 128 × 38 mm
  - lifetime: 25 000 hours
  - beam angle: 120°
- = packaging: 1 pc, small box



**ZS2163** 1/-/-/6  
15 39 300 622 ZS2163

- power: 10 W
- length: 500 mm
- luminous flux: 1 000 lm
- color temperature: 4 000 K
- light color: neutral white
- material: aluminium (Al)
- dimensions: 500 × 128 × 38 mm
- lifetime: 25 000 hours
- beam angle: 120°

= packaging: 1 pc, small box



	<b>10 W</b>				<b>4 000 K</b> NEUTRAL WHITE	<b>3</b> YEARS WARRANTY
--	-------------	--	--	--	---------------------------------	----------------------------



<b>ZS2164</b>	1/-/-/6
15 39 301 022	ZS2164

- power: 6 W
- length: 300 mm
- luminous flux: 700 lm
- color temperature: 4 000 K
- light color: neutral white
- material: aluminium (Al)
- dimensions: 300 × 128 × 38 mm
- lifetime: 25 000 hours
- beam angle: 120°

= packaging: 1 pc, small box



	<b>6 W</b>				<b>4 000 K</b> NEUTRAL WHITE	<b>3</b> YEARS WARRANTY
--	------------	--	--	--	---------------------------------	----------------------------



<b>ZS2166</b>	1/-/-/6
15 39 300 623	ZS2166

- power: 10 W
- length: 500 mm
- luminous flux: 1 000 lm
- color temperature: 4 000 K
- light color: neutral white
- material: aluminium (Al)
- dimensions: 500 × 128 × 38 mm
- lifetime: 25 000 hours
- beam angle: 120°

= packaging: 1 pc, small box



	<b>10 W</b>				<b>4 000 K</b> NEUTRAL WHITE	<b>3</b> YEARS WARRANTY
--	-------------	--	--	--	---------------------------------	----------------------------



<b>ZS2167</b>	1/-/-/6
15 39 301 023	ZS2167

# Luminaires

## Lamps and desk lamps

### Desk lamps

- new models of table lamps with bulb socket or built-in LED
- modern design with wood decor
- suitable for study rooms, children's rooms or as interior decoration

- model: POPPY
- power: 25 W
- colour: white
- supply cable length: 1.5 m
- power adaptor: 220-230 V
- dimensions: 150 × 150 × 400 mm
- packaging: 1 pc, box

**Z7640W**

1/-/-/3

15 38 201 000

Z7640W

- model: POPPY
- power: 25 W
- colour: pink
- supply cable length: 1.5 m
- power adaptor: 220-230 V
- dimensions: 150 × 150 × 400 mm
- packaging: 1 pc, box

**Z7640P**

1/-/-/3

15 38 201 100

Z7640P

- model: POPPY
- power: 25 W
- colour: green
- supply cable length: 1.5 m
- power adaptor: 220-230 V
- dimensions: 150 × 150 × 400 mm
- packaging: 1 pc, box

**Z7640GR**

1/-/-/3

15 38 201 200

Z764GR



www.emos.eu

Order Code  
Item Number

Packaging  
Type

- model: NINA
- power: 25 W
- colour: black
- supply cable length: 1.5 m
- power adaptor: 220-240 V
- dimensions: 150 × 150 × 385 mm
- packaging: 1 pc, box



**Z7642B** 1/-/-2  
15 38 201 500 Z7642B

- model: NINA
- power: 25 W
- colour: gold
- supply cable length: 1.5 m
- power adaptor: 220-240 V
- dimensions: 150 × 150 × 400 mm
- packaging: 1 pc, box



**Z7642GL** 1/-/-2  
15 38 201 600 Z7642GL

- model: TARA
- power: 4.5 W
- luminous flux: 280 lm
- colour: black
- supply cable length: 1.6 m
- power adaptor: 220-240 V
- number of LED: 14
- color temperature: 4 000 K
- dimensions: 130 × 130 × 360 mm

- color rendering index (CRI): Ra > 85
- packaging: 1 pc, box



**Z7641B** 1/-/-8  
15 38 201 300 Z7641B

- model: TARA
- power: 4.5 W
- luminous flux: 280 lm
- colour: white
- supply cable length: 1.6 m
- power adaptor: 220-240 V
- number of LED: 14
- color temperature: 4 000 K
- dimensions: 130 × 130 × 360 mm

- color rendering index (CRI): Ra > 85
- packaging: 1 pc, box



**Z7641W** 1/-/-8  
15 38 201 400 Z7641W

## Grow lamps

- growth lamps for germination, seedling development and plant vit
- effectively replace sunlight on cloudy days and in shaded areas
- timer ensures plants receive exactly the amount of light they need

- model: EM101
- power: 5 W
- luminous flux: 235 lm
- colour: white
- supply cable length: 1.5 m
- power adaptor: USB-A cable
- number of LED: 15
- color temperature: 3 500 K
- dimensions: 110 × 110 × 220 mm
- color rendering index (CRI): Ra > 85
- packaging: 1 pc, box

**Z7901**

1/-/-/20

15 38 900 010

Z7901

- model: EM102
- power: 8 W
- luminous flux: 300 lm
- colour: white
- supply cable length: 1.7 m
- power adaptor: USB-A cable
- number of LED: 39
- color temperature: 3 100 K
- dimensions: 120 × 120 × 195 mm
- color rendering index (CRI): Ra > 80
- packaging: 1 pc, box

**Z7902**

1/-/-/20

15 38 900 020

Z7902

- model: EM103
- power: 15 W
- luminous flux: 800 lm
- colour: white
- supply cable length: 1.5 m
- power adaptor: 24 V DC/1000 mA, included
- number of LED: 28
- color temperature: 3 900 K
- dimensions: 536 × 180 × 215 mm
- color rendering index (CRI): Ra > 95
- packaging: 1 pc, box

**Z7903**

1/-/-/10

15 38 900 030

Z7903

- model: EM104
- power: 7 W
- luminous flux: 300 lm
- colour: white
- supply cable length: 1.7 m
- power adaptor: USB-A cable
- number of LED: 30
- color temperature: 3 200 K
- dimensions: 318 × 134 × 186 mm
- color rendering index (CRI): Ra > 80
- packaging: 1 pc, box

**Z7904**

1/-/-/6

15 38 900 040

Z7904

**EMOS**A brand of 

www.emos.eu

Order Code  
Item NumberPackaging  
Type

- model: EM105
- power: 7 W
- luminous flux: 450 lm
- colour: white
- supply cable length: 1.5 m
- power adaptor: 24 V DC/1000 mA, included
- number of LED: 21
- color temperature: 3 800 K
- dimensions: 210 × 210 × 517 mm

- color rendering index (CRI): Ra >95
- packaging: 1 pc, box

**Z7905**

1/-/-/6

15 38 900 050

Z7905

## Luminaires

## Sensors

### Sensors GoSmart



- Sensors to secure your home
- Motion detection and instant notification in the app
- Window and door security check
- Real-time identification of unusual situations
- Connect to your home network via ZigBee protocol
- Compatibility with EMOS GoSmart products and TUYA devices
- Voice control with Google Assistant and Amazon Alexa

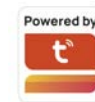

- product: motion sensor
- detection angle: 60°
- detection distance: 8 m
- IP rating: IP20
- sensor type: PIR
- power source: 1× CR123A (3 V)
- packaging: 1 pc, paper box
- supported OS: Android, iOS
- compatibility: EMOS GoSmart, TUYA, LIDL, Smartlife
- protocol: Zigbee 3.0
- transmission frequency: 2,4 GHz ZigBee (IEEE 802.15.4)
- notifications to the mobile app
- application languages: EN, CZ, SK, PL, DE, HU, SI, FR,
- mounting type: surface-mounted

**H5024**

1/-/-/72

30 69 052 040

IP-2310Z

- product: door/window sensor
- IP rating: IP20
- sensor type: magnetic
- power source: 1× CR2032 (3 V)
- packaging: 1 pc, paper box
- supported OS: Android, iOS
- compatibility: EMOS GoSmart, TUYA, LIDL, Smartlife
- protocol: Zigbee 3.0
- transmission frequency: 2,4 GHz ZigBee (IEEE 802.15.4)
- notifications to the mobile app
- application languages: EN, CZ, SK, PL, DE, HU, SI, FR,

ZigBee 3.0

**H5025**

1/-/-/96

30 69 052 050

IP-2111Z

## PIR sensors

- practical solution for automatic lighting control
- reliable detection of people
- high resistance to interference
- helps reduce electricity consumption
- suitable for corridors, staircases, entrances and technical rooms
- easy installation and simple setup
- modern and discreet design

- product: motion sensor
  - detection angle: 360°
  - detection distance: 6 m
  - switching time: min. 10 sekunds – max. 15 minutes
  - IP rating: IP20
  - sensor type: PIR
  - power source: 220–240 V~
  - max. resistive load: 1 200 W
  - packaging: 1 pc, small box
- mounting type: surface-mounted

**GS11111**

1/-/-/20

14 54 008 200

GS11111



- product: motion sensor
  - detection angle: 180°
  - detection distance: 12 m
  - switching time: min. 10 sekunds – max. 15 minutes
  - IP rating: IP65
  - sensor type: PIR
  - power source: 220–240 V~
  - max. resistive load: 1 200 W
  - packaging: 1 pc, small box
- mounting type: surface-mounted

**GS11151**

1/-/-/40

14 54 015 200

GS11151



- product: motion sensor
  - detection angle: 360°
  - detection distance: 20 m
  - switching time: min. 30 seconds - max. 60 minutes
  - IP rating: IP54
  - sensor type: PIR
  - power source: 220–240 V~
  - packaging: 1 pc, small box
  - compatibility: DALI
- protocol: DALI
  - mounting type: attached/recessed
  - mounting hole: 56–60 mm

**GS13142**

1/-/-/40

14 54 000 100

GS13142



- product: motion sensor
  - detection angle: 360°
  - detection distance: 8 m
  - switching time: min. 10 seconds – max. 30 minutes
  - IP rating: IP65
  - sensor type: PIR
  - power source: 220–240 V~
  - max. resistive load: 2 000 W
  - packaging: 1 pc, small box
- mounting type: surface-mounted

**GS11A51**

1/-/-/40

14 54 000 400

GS11A51



- product: motion sensor
- detection angle: 360°
- detection distance: 8 m
- switching time: min. 10 seconds – max. 30 minutes
- IP rating: IP65
- sensor type: PIR
- power source: 220–240 V~
- max. resistive load: 2 000 W
- packaging: 1 pc, small box

▪ mounting type: surface-mounted



**GS11B51**

1/-/-/40

14 54 000 500

GS11B51

- product: motion sensor
- detection angle: 180°/360°
- detection distance: 12 m
- switching time: min. 10 sekunds – max. 15 minutes
- IP rating: IP65
- sensor type: PIR
- power source: 220–240 V~
- max. resistive load: 1 200 W
- packaging: 1 pc, small box

▪ mounting type: surface-mounted



**GS14151**

1/-/-/40

14 54 000 600

GS14151

- product: motion sensor
- detection angle: 180°/360°
- detection distance: 12 m
- switching time: min. 10 sekunds – max. 15 minutes
- IP rating: IP65
- sensor type: PIR
- power source: 220–240 V~
- max. resistive load: 1 200 W
- packaging: 1 pc, small box

▪ mounting type: surface-mounted



**GS14251**

1/-/-/40

14 54 000 700

GS14251

- product: motion sensor
- detection angle: 160°
- detection distance: 9 m
- switching time: min. 10 sekunds – max. 15 minutes
- IP rating: IP20
- sensor type: PIR
- power source: 220–240 V~
- max. resistive load: 1 200 W
- packaging: 1 pc, small box

▪ mounting type: recessed



**GS15117**

1/-/-/40

14 54 000 800

GS15117

- product: motion sensor
- detection angle: 360°
- detection distance: 3 m
- switching time: min. 10 sekunds – max. 15 minutes
- IP rating: IP20
- sensor type: PIR
- power source: 220–240 V~
- max. resistive load: 1 200 W
- packaging: 1 pc, small box

▪ mounting type: recessed  
▪ mounting hole: 63–66 mm



**GS12111**

1/-/-/36

14 54 016 100

GS12111

**EMOS**A brand of 

www.emos.eu

Order Code  
Item NumberPackaging  
Type

- product: motion sensor
- detection angle: 190°
- detection distance: 10 m
- switching time: min. 10 seconds – max. 7 minutes
- IP rating: IP20
- sensor type: PIR
- power source: 220–240 V~
- max. resistive load: 500 W
- packaging: 1 pc, small box



8 592920 157312

**GS15114**

1/-/-/40

14 55 000 900

GS15114

## Microwave sensors

- automatically switch lights on at dusk and off at dawn
- ensure convenient and worry-free control of outdoor lighting
- help reduce electricity consumption
- ideal for gardens, driveways, entrances and parking areas
- reliable operation under all lighting conditions
- easy installation and simple setup
- practical solution for residential and commercial spaces

- product: motion sensor
- detection angle: 360°
- detection distance: 16 m
- switching time: min. 10 seconds – max. 12 minutes
- IP rating: IP20
- sensor type: microwave
- power source: 220–240 V~
- max. resistive load: 1 200 W
- packaging: 1 pc, small box

- mounting type: recessed
- mounting hole: 63–66 mm



8 592920 152102

**GS22111**

1/-/-/24

14 54 013 200

GS22111

- product: motion sensor
- detection angle: 360°
- detection distance: 6 m
- switching time: min. 10 seconds – max. 12 minutes
- IP rating: IP20
- sensor type: microwave
- power source: 220–240 V~
- max. resistive load: 2 000 W
- packaging: 1 pc, small box

- mounting type: surface-mounted



8 592920 157176

**GS31111**

1/-/-/40

14 54 000 200

GS31111

- product: motion sensor
- detection angle: 360°
- detection distance: 6 m
- switching time: min. 10 seconds – max. 12 minutes
- IP rating: IP20
- sensor type: microwave
- power source: 220–240 V~
- max. resistive load: 2 000 W
- packaging: 1 pc, small box

- mounting type: recessed
- mounting hole: 63–66 mm



8 592920 157190

**GS32111**

1/-/-/30

14 54 000 300

GS32111

- product: motion sensor
  - detection angle: 360°
  - detection distance: 8 m
  - switching time: min. 10 seconds – max. 12 minutes
  - IP rating: IP20
  - sensor type: microwave
  - power source: 220–240 V~
  - max. resistive load: 2 000 W
  - packaging: 1 pc, small box
- mounting type: surface-mounted



**GS21111**

1/-/-/36

14 54 017 100

GS21111

## Twilight sensors

- reliability in demanding environments
- instant response – extremely fast detection with no delay
- suitable for automated systems
- universal use in residential and commercial areas
- modern design

- product: dusk sensor
- switching time: 1 hour - 9 hours
- IP rating: IP65
- sensor type: twilight sensor
- power source: 220–240 V~
- max. resistive load: 1 800 W
- packaging: 1 pc, small box
- mounting type: surface-mounted



**GS41151**

1/-/-/50

14 54 000 110

GS41151

# Decorations

## Connecting systems

### PREMIUM connect system

- Unique EMOS connection system for light chains
- Connect up to 2,000 LEDs with a single adapter
- Choice of classic chains or icicle lights
- Warm, cool or mixed twinkling light color
- Suitable for Christmas, wedding and festive lighting
- 3 year warranty

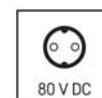

**DOAW01** 1/-/-/36  
15 50 060 000 DOAW01



- product: chain
- light color: warm white
- dimensions: 5 m
- area of use: both outdoor and indoor
- function: glowing
- number of LED: 50

- supply line length: 10 cm
- cable colour: black
- power: max. 24 W
- IP rating: IP44
- lifetime: 10 000 hours
- packaging: 1 pc, box



**DOAW02** 1/-/-/36  
15 50 060 001 DOAW02



- product: chain
- light color: warm white
- dimensions: 5 m
- area of use: both outdoor and indoor
- function: glowing
- number of LED: 50

- supply line length: 10 cm
- cable colour: white
- power: max. 24 W
- IP rating: IP44
- lifetime: 10 000 hours
- packaging: 1 pc, box



**DOAW03** 1/-/-/16  
15 50 060 002 DOAW03



- product: chain
- light color: warm white
- dimensions: 10 m
- area of use: both outdoor and indoor
- function: glowing
- number of LED: 100

- supply line length: 10 cm
- cable colour: black
- power: max. 24 W
- IP rating: IP44
- lifetime: 10 000 hours
- packaging: 1 pc, box



**DOAC01** 1/-/-/36  
15 50 062 000 DOAC01



- product: chain
- light color: cool white
- dimensions: 5 m
- area of use: both outdoor and indoor
- function: glowing
- number of LED: 50

- supply line length: 10 cm
- cable colour: black
- power: max. 24 W
- IP rating: IP44
- lifetime: 10 000 hours
- packaging: 1 pc, box



**DOAC02** 1/-/-/36  
15 50 062 001 DOAC02



- product: chain
- light color: cool white
- dimensions: 5 m
- area of use: both outdoor and indoor
- function: glowing
- number of LED: 50

- supply line length: 10 cm
- cable colour: white
- power: max. 24 W
- IP rating: IP44
- lifetime: 10 000 hours
- packaging: 1 pc, box



**DOAC03** 1/-/-/16  
15 50 062 002 DOAC03





- product: chain
- light color: cool white
- dimensions: 10 m
- area of use: both outdoor and indoor
- function: glowing
- number of LED: 100

- supply line length: 10 cm
- cable colour: black
- power: max. 24 W
- IP rating: IP44
- lifetime: 10 000 hours
- packaging: 1 pc, box



**DOAC04** 1/-/-/16  
15 50 062 007 DOAC04



- product: chain
- light color: cool white
- dimensions: 10 m
- area of use: both outdoor and indoor
- function: glowing/blinking
- number of LED: 100
- supply line length: 10 cm
- cable colour: black
- power: max. 24 W
- IP rating: IP44
- lifetime: 10 000 hours
- packaging: 1 pc, box

**DOAN01** 1/-/-/16  
15 50 063 002 DOAN01





- product: chain
- light color: WW/CW
- dimensions: 10 m
- area of use: both outdoor and indoor
- function: glowing/blinking
- number of LED: 100
- supply line length: 10 cm
- cable colour: black
- power: max. 24 W
- IP rating: IP44
- lifetime: 10 000 hours
- packaging: 1 pc, box

**DOCW01** 1/-/-/24  
15 50 060 003 DOCW01



- product: icicles
- light color: warm white
- dimensions: 3 × 0.4 m
- area of use: both outdoor and indoor
- function: glowing
- number of LED: 50
- supply line length: 10 cm
- cable colour: black
- power: max. 24 W
- IP rating: IP44
- lifetime: 10 000 hours
- packaging: 1 pc, box

**DOCW02** 1/-/-/24  
15 50 060 004 DOCW02



- product: icicles
- light color: warm white
- dimensions: 3 × 0.4 m
- area of use: both outdoor and indoor
- function: glowing
- number of LED: 50
- supply line length: 10 cm
- cable colour: white
- power: max. 24 W
- IP rating: IP44
- lifetime: 10 000 hours
- packaging: 1 pc, box

**DOCW03** 1/-/-/24  
15 50 060 005 DOCW03



- product: icicles
- light color: warm white
- dimensions: 3 × 0.4 m
- area of use: both outdoor and indoor
- function: glowing/blinking
- number of LED: 50
- supply line length: 10 cm
- cable colour: black
- power: max. 24 W
- IP rating: IP44
- lifetime: 10 000 hours
- packaging: 1 pc, box

**DOCW04** 1/-/-/24  
15 50 060 006 DOCW04



- product: icicles
- light color: warm white
- dimensions: 3 × 0.4 m
- area of use: both outdoor and indoor
- function: glowing/blinking
- number of LED: 50
- supply line length: 10 cm
- cable colour: white
- power: max. 24 W
- IP rating: IP44
- lifetime: 10 000 hours
- packaging: 1 pc, box

**DOCC01** 1/-/-/24  
15 50 062 003 DOCC01



- product: icicles
- light color: cool white
- dimensions: 3 × 0.4 m
- area of use: both outdoor and indoor
- function: glowing
- number of LED: 50
- supply line length: 10 cm
- cable colour: black
- power: max. 24 W
- IP rating: IP44
- lifetime: 10 000 hours
- packaging: 1 pc, box

**DOCC02** 1/-/-/24  
15 50 062 004 DOCC02



- product: icicles
- light color: cool white
- dimensions: 3 × 0.4 m
- area of use: both outdoor and indoor
- function: glowing
- number of LED: 50
- supply line length: 10 cm
- cable colour: white
- power: max. 24 W
- IP rating: IP44
- lifetime: 10 000 hours
- packaging: 1 pc, box

**DOCC03** 1/-/-/24  
15 50 062 005 DOCC03

- product: icicles
- light color: cool white
- dimensions: 3 × 0.4 m
- area of use: both outdoor and indoor
- function: glowing/blinking
- number of LED: 50
- supply line length: 10 cm
- cable colour: black
- power: max. 24 W
- IP rating: IP44
- lifetime: 10 000 hours
- packaging: 1 pc, box

**DOCC04** 1/-/-/24  
15 50 062 006 DOCC04

- product: icicles
- light color: cool white
- dimensions: 3 × 0.4 m
- area of use: both outdoor and indoor
- function: glowing/blinking
- number of LED: 50
- supply line length: 10 cm
- cable colour: white
- power: max. 24 W
- IP rating: IP44
- lifetime: 10 000 hours
- packaging: 1 pc, box

**EMOS**A brand of  Legrand

www.emos.eu

Order Code  
Item NumberPackaging  
Type**DOCN01**

1/-/-/24

15 50 063 000

DOCN01



8 592920 159996

- product: icicles
- light color: WW/CW
- dimensions: 3 × 0.4 m
- area of use: both outdoor and indoor
- function: glowing/blinking
- number of LED: 50

- supply line length: 10 cm
- cable colour: black
- power: max. 24 W
- IP rating: IP44
- lifetime: 10 000 hours
- packaging: 1 pc, box

**DOCN02**

1/-/-/24

15 50 063 001

DOCN02



8 592920 159897

- product: icicles
- light color: WW/CW
- dimensions: 3 × 0.4 m
- area of use: both outdoor and indoor
- function: glowing/blinking
- number of LED: 50

- supply line length: 10 cm
- cable colour: white
- power: max. 24 W
- IP rating: IP44
- lifetime: 10 000 hours
- packaging: 1 pc, box

**DOZB01**

1/-/5/30

15 50 065 000

DOZB01



8 592920 160046

- product: cable
- timer: no
- remote control: no
- area of use: both outdoor and indoor
- supply line length: 10 m
- input voltage: 80 V DC

- IP rating: IP44
- packaging: 1 pc, hanging

**DOZW01**

1/-/5/30

15 50 065 003

DOZW01



8 592920 160015

- product: cable
- timer: no
- remote control: no
- area of use: both outdoor and indoor
- supply line length: 10 m
- input voltage: 80 V DC

- IP rating: IP44
- packaging: 1 pc, hanging

**DOZB03**

1/-/10/160

15 50 065 002

DOZB03



8 592920 160077

- product: splitter
- timer: no
- remote control: no
- area of use: both outdoor and indoor
- supply line length: 0,4 m
- input voltage: 80 V DC

- IP rating: IP44
- packaging: 1 pc, hanging

**DOZB02**

1/-/-/48

15 50 065 001

DOZB02



8 592920 160107

- product: adapter
- timer
- remote control: yes (CR2032, included)
- area of use: both outdoor and indoor
- power supply type: AC adapter
- input voltage: 230 V AC

- power: 24 W
- IP rating: IP44
- packaging: 1 pc, box



# Decorations



## Nano chains

### Nano chains cluster

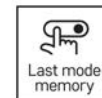
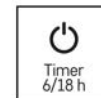
- Stylish light chains densely decorated with fine LEDs
- Includes a practical spool for easy installation and storage
- Available in various lengths for decorating trees up to 2 meters
- Warm, cool or colored light
- Ideal for Christmas, wedding and festive lighting





**D3FW02** 1/-/-/7  
15 50 030 036 D3FW02



- product: hedgehog
- light color: warm white
- dimensions: 9,6 m
- area of use: both outdoor and indoor
- timer
- function: 8 modes (multi-functional)
- number of LED: 960
- supply line length: 5 m
- cable colour: copper
- power: 5,9 W
- IP rating: IP44
- lifetime: 10 000 hours

**D3FW03** 1/-/-/7  
15 50 030 037 D3FW03



- product: hedgehog
- light color: warm white
- dimensions: 14,4 m
- area of use: both outdoor and indoor
- timer
- function: 8 modes (multi-functional)
- number of LED: 1 440
- supply line length: 5 m
- cable colour: copper
- power: 7,1 W
- IP rating: IP44
- lifetime: 10 000 hours

**D3FW04** 1/-/-/7  
15 50 030 038 D3FW04



- product: hedgehog
- light color: warm white
- dimensions: 19,2 m
- area of use: both outdoor and indoor
- timer
- function: 8 modes (multi-functional)
- number of LED: 1 920
- supply line length: 5 m
- cable colour: copper
- power: 8,3 W
- IP rating: IP44
- lifetime: 10 000 hours

**D3FC02** 1/-/-/7  
15 50 032 011 D3FC02



- product: hedgehog
- light color: cool white
- dimensions: 9,6 m
- area of use: both outdoor and indoor
- timer
- function: 8 modes (multi-functional)
- number of LED: 960
- supply line length: 5 m
- cable colour: silver
- power: 5,9 W
- IP rating: IP44
- lifetime: 10 000 hours

**D3FC03** 1/-/-/7  
15 50 032 012 D3FC03



- product: hedgehog
- light color: cool white
- dimensions: 14,4 m
- area of use: both outdoor and indoor
- timer
- function: 8 modes (multi-functional)
- number of LED: 1 440
- supply line length: 5 m
- cable colour: silver
- power: 7,1 W
- IP rating: IP44
- lifetime: 10 000 hours

**D3FC04** 1/-/-/7  
15 50 032 013 D3FC04

- product: hedgehog
- light color: cool white
- dimensions: 19,2 m
- area of use: both outdoor and indoor
- timer
- function: 8 modes (multi-functional)
- number of LED: 1 920
- supply line length: 5 m
- cable colour: silver
- power: 8,3 W
- IP rating: IP44
- lifetime: 10 000 hours

**D3FM02** 1/-/-/7  
15 50 034 004 D3FM02

- product: hedgehog
- light color: multicolor
- dimensions: 9,6 m
- area of use: both outdoor and indoor
- timer
- function: 8 modes (multi-functional)
- number of LED: 960
- supply line length: 5 m
- cable colour: silver
- power: 5,9 W
- IP rating: IP44
- lifetime: 10 000 hours

**D3FM03** 1/-/-/7  
15 50 034 005 D3FM03

- product: hedgehog
- light color: multicolor
- dimensions: 14,4 m
- area of use: both outdoor and indoor
- timer
- function: 8 modes (multi-functional)
- number of LED: 1 440
- supply line length: 5 m
- cable colour: silver
- power: 7,1 W
- IP rating: IP44
- lifetime: 10 000 hours

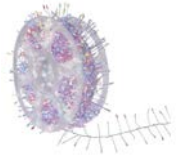
**D3FM04** 1/-/-/7  
15 50 034 006 D3FM04

- product: hedgehog
- light color: multicolor
- dimensions: 19,2 m
- area of use: both outdoor and indoor
- timer
- function: 8 modes (multi-functional)
- number of LED: 1 920
- supply line length: 5 m
- cable colour: silver
- power: 8,3 W
- IP rating: IP44
- lifetime: 10 000 hours

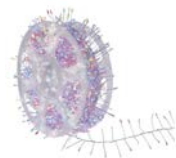
## Decorations

## Decorations

## Projectors

- simple and highly effective lighting decoration for indoor and outd
- can be installed on a stand or ground stake
- various seasonal animation themes – Christmas, Halloween, New

- product: projector
- technology: LED
- light color: cool white
- timer
- remote control: no
- pattern: Halloween, Christmas, New Year's Eve
- function: rotating light
- area of use: both outdoor and indoor
- power supply type: AC adapter
- supply line length: 3 m
- power: 3,6 W
- input voltage: 230 V~
- output voltage: 12 V DC
- IP rating: IP44
- lifetime: 10 000 hours
- material: plastic
- warranty period: 2 years
- packaging: 1 pc, box



cool white



**DCPC10**  
15 50 005 022

1/-/-/10  
DCPC10

# Garlands

- versatile use throughout the house
- easy installation
- ideal for creating a festive and cozy atmosphere
- timer function – decorations turn on and off by themselves

- product: curtain
- light color: warm white
- dimensions: 190 × 50 cm
- area of use: both outdoor and indoor
- timer
- remote control: no
- number of LED: 125
- supply line length: 3 m
- power: 3.5 W

- IP rating: IP44
- lifetime: 10 000 hours



warm white



**DCGW17** 1/-/-/14  
15 50 000 193 DCGW17

- product: curtain
- light color: cool white
- dimensions: 160 × 95 cm
- area of use: both outdoor and indoor
- timer
- remote control: no
- number of LED: 131
- supply line length: 3 m
- power: 3,2 W

- IP rating: IP44
- lifetime: 10 000 hours



cool white



**DCGC02** 1/-/-/5  
15 50 002 048 DCGC02

- product: curtain
- light color: warm white
- dimensions: 170 × 85 cm
- area of use: both outdoor and indoor
- timer
- remote control: no
- number of LED: 120
- supply line length: 1 m
- power: 0,43 W

- IP rating: IP44
- lifetime: 10 000 hours



warm white **8** MULTI FUNCTIONS



**DCGW18** 1/-/-/10  
15 50 000 194 DCGW18

- product: curtain
- light color: cool white
- dimensions: 170 × 85 cm
- area of use: both outdoor and indoor
- timer
- remote control: no
- number of LED: 120
- supply line length: 1 m
- power: 0,43 W

- IP rating: IP44
- lifetime: 10 000 hours

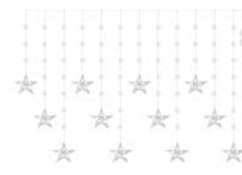

cool white **8** MULTI FUNCTIONS



**DCGC03** 1/-/-/10  
15 50 002 049 DCGC03

## Bethlehems

- traditional Christmas decoration in a modern design
- practical size
- timer switches the light on and off automatically after the set period

- product: nativity scene
- light color: warm white
- dimensions: 16,5 × 10 × 19 cm
- area of use: indoor
- timer
- remote control: no
- number of LED: 20
- power: 0,05 W
- IP rating: IP20

▪ lifetime: 10 000 hours



8 592920 160497

**DCWW44**

1/-/-/10

15 50 000 197

DCWW44

## LED candles

- decorative candles for indoor use
- the timer automatically turns the candle on and off
- convenient power supply using standard batteries

- product: candle
- light color: warm white
- dimensions: 7,5 × 10 cm/12,5 cm
- area of use: indoor
- timer
- remote control: yes (1× CR2025, included)
- number of LED: 2× 1
- power: 2× 0,006 W
- IP rating: IP20

▪ lifetime: 10 000 hours



8 592920 159255

**DCCV25**

1/-/-/6

15 50 000 196

DCCV25

## Other decorations

- creating a Christmas atmosphere and brightening the interior
- timer function – decorations turn on and off by themselves
- versatile use not only for Christmas
- practical power supply with commonly available batteries
- easy installation
- great gift for your loved ones

- product: star
  - light color: warm white
  - dimensions: 40 × 40 cm
  - area of use: both outdoor and indoor
  - timer
  - remote control: no
  - number of LED: 60
  - supply line length: 0.5 m
  - power: 0,17 W
- IP rating: IP44
  - lifetime: 10 000 hours

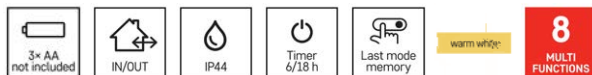

8 592920 159279

**DCGW19**

1/-/-/10

15 50 000 195

DCGW19

# Weather stations, thermometers, scales, others



## Weather stations

### Weather stations GoSmart



- Can evaluate current weather and predict its further development
- Display temperature and humidity and exact date and time
- Wireless communication with up to 3 sensors (AA/AAA batteries)
- Large color display, LED backlight (perm/temp) and projection
- Connection to home network via WiFi
- Compatibility with EMOS GoSmart products and TUYA devices
- Voice control with Google Assistant and Amazon Alexa



- LED backlight display
- the possibility of hanging on the wall
- color backlight display (Black Mask)
- date
- calendar
- alarm clock
- outdoor temperature: -40 °C to +70 °C, resolution 0.1
- indoor temperature: -10 °C to +50 °C, resolution 0.1
- outdoor humidity: 1 % až 99 % RV, resolution 1 %
- indoor humidity: 1 % to 99 % RH, resolution 1 %
- min. and max. temperature
- weather forecast
- temperature warning
- barometer
- rain gauge
- anemometer
- moon phase
- range of the sensor: up to 100 m



**E6001**

1/-/-/2

26 06 187 000

E6001

- outdoor temperature: 1. -40 °C to +70 °C, resolution
- outdoor humidity: 1 % až 99 % RV, resolution 1 %
- weather forecast: yes - only in app
- temperature warning: yes - only in the application
- rain gauge
- anemometer
- range of the sensor: up to 100 m
- possible additional sensor: 3 (E06000)
- main unit size: 60 × 60 × 61 mm



**E6000**

1/-/-/2

26 06 188 000

E6000

# Weather stations

- can evaluate current weather and predict its further development
- display temperature and humidity (in and out), time and date
- wireless comm. with up to 3 sensors (powered by AA or AAA)
- large colour display, LED backlight (perm/temp) & projector
- with stand/for hanging on the wall, +battery or mains powered

LED backlight display = the possibility of hanging on the wall = color backlight display (Black Mask) = alarm clock = outdoor temperature: -50 °C to +70 °C, resolution 0.1 °C = indoor temperature: -10 °C to +50 °C, resolution 0.1 °C = outdoor humidity: 20 % to 95 % RH, resolution 1 % = indoor humidity: 20 % to 95 % RH, resolution 1 % = min. and max. temperature = weather forecast = range of the sensor: up to 50 m = possible additional sensor: yes, 1 sensor (E05018) = main unit size: 20 × 85 × 96 mm



**E8647N** 1/-/-/20  
26 06 184 000 E8647N

LED backlight display = the possibility of hanging on the wall = color backlight display (Black Mask) = alarm clock = outdoor temperature: -50 °C to +70 °C, resolution 0.1 °C = indoor temperature: -10 °C to +50 °C, resolution 0.1 °C = outdoor humidity: 20 % to 95 % RH, resolution 1 % = indoor humidity: 20 % to 95 % RH, resolution 1 % = min. and max. temperature = weather forecast = range of the sensor: up to 50 m = possible additional sensor: yes, 1 sensor (E05018) = main unit size: 85 × 20 × 96 mm



**E8647W** 1/-/-/20  
26 06 185 000 E8647W

LED backlight display = the possibility of hanging on the wall = color backlight display (Black Mask) = time zones = date = calendar = alarm clock = outdoor temperature: -40 °C to +70 °C, resolution 0.1 °C = indoor temperature: 0 °C to +50 °C, resolution 0.1 °C = outdoor humidity: 20 % to 99 % RH, resolution 1 % = indoor humidity: 20 % to 99 % RH, resolution 1 % = min. and max. temperature = weather forecast = temperature warning = pressure trend = barometer = moon phase = range of the sensor: up to 80 m = possible additional sensor: 3 (E05018) = main unit size: 284 × 25 × 107 mm



**E8625** 1/-/-/10  
26 06 186 000 E8625

# Thermometers

## Thermometers

- displays indoor & outdoor temperature, some also humidity
- wireless or with probe (wire-connected, out the window)
- measures indoor humidity via integrated sensor in the body
- selected models also feature calendar, alarm and ice warning
- can be hung on a wall, window or stand

thermometer design: wireless = clock: yes, quartz = LED backlight display = date = alarm clock = snooze = indoor temperature: -10 °C to +50 °C, resolution 0.1 °C = indoor humidity: 10 % to 95 % RH, resolution 1 % = min. and max. temperature = power of station: 1× 1.5 V AA (not included) = main unit size: 88 × 37 × 86 mm = screen size: 75 × 64 mm

**E0114N**

1/-/-/20

26 03 124 000

E0114N

thermometer design: wireless = indoor temperature: -10 °C to +50 °C, resolution 0.1 °C = indoor humidity: 1 % to 99 % RH, resolution 1 % = min. and max. temperature = the possibility of hanging on the wall = power of station: 2× 1.5 V AAA (not included) = main unit size: 66 × 25 × 100 mm = screen size: 53 × 82 mm

**E0558**

1/-/-/20

26 03 206 000

E0558

thermometer design: wireless = clock: yes, quartz = date = alarm clock = snooze = indoor temperature: -10 °C to +50 °C, resolution 0.1 °C = indoor humidity: 1 % to 99 % RH, resolution 1 % = outdoor temperature: -40 °C to +60 °C, resolution 0.1 °C = outdoor humidity: 1 % až 99 % RV, resolution 1 % = min. and max. temperature = range in open space: up to 100 m = possible additional sensor: 3 (E00387) = the possibility of hanging on the wall = power of station: 2× 1.5 V AAA (not included) = power of sensor: 2× 1.5 V AA (not included) = main unit size: 66 × 25 × 100 mm = sensor size: 21 × 38 × 100 mm = screen size: 53 × 82 mm

**E0558W**

1/-/-/20

26 03 208 000

E0558W

thermometer design: wire = clock: yes, quartz = alarm clock = snooze = indoor temperature: -10 °C to +50 °C, resolution 0.1 °C = indoor humidity: 1 % to 99 % RH, resolution 1 % = outdoor temperature: -50 °C to +70 °C, resolution 0.1 °C = min. and max. temperature = wired probe for sensor: 1,9 m, Ø 14 mm = the possibility of hanging on the wall = power of station: 2× 1.5 V AAA (not included) = main unit size: 66 × 25 × 100 mm = screen size: 53 × 82 mm



**E0558P**

1/-/-/20

26 03 207 000

E0558P



designed for the type of main unit: E8610, E8614, E8620, E8625, E8636, E8647N, E8647W = range in open space: up to 100 m = operating temperature: -40 °C to +70 °C, resolution 0.1 °C = power source: 2× 1.5 V AA (not included) = dimensions: 95 × 95 × 156 mm



**E00032**

1/-/-/20

26 03 209 000

E00032

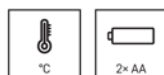

## Spare sensors

- wireless sensors and wired probes for EMOS weather stations
- measure outdoor temperature and humidity
- range of up to 25–100 m in an open area

designed for the type of main unit: E6000 = indicator of outdoor humidity: 1 % to 99 % RH, resolution 1 % = range in open space: up to 100 m = operating temperature: -40 °C to +70 °C, resolution 0.1 °C = power source: 2× 1.5 V AA (not included) = dimensions: 50 × 33 × 96 mm



**E06000**

1/-/-/50

26 93 000 250

E06000



# TV and audio accessories



## TV wall mounts

- fixed, tilting and bracket mounts for TVs of various sizes
- meet strictest rigidity, load and variability requirements
- in various sizes, with high load capacity
- installation material for standard wall types included

- holder type: fix
- screen diagonal: 26–60" (65–152 cm)
- min. VESA mounting dimensions: 75 × 75 mm
- max. VESA mounting dimensions: 400 × 400 mm
- distance from a wall: 23 mm
- max. load capacity (kg): 50
- dimensions: 450 × 430 × 23 mm
- packaging: 1 pc, paper box



**KT01F**

32 32 101 000

1/-/-/10

KT01F

- holder type: fix
- screen diagonal: 42–100" (107–254 cm)
- min. VESA mounting dimensions: 75 × 75 mm
- max. VESA mounting dimensions: 700 × 600 mm
- distance from a wall: 33 mm
- max. load capacity (kg): 100
- dimensions: 770 × 600 × 33 mm
- packaging: 1 pc, paper box



**KT02F**

32 32 102 000

1/-/-/2

KT02F

- holder type: fix
- screen diagonal: 50–120" (127–305 cm)
- min. VESA mounting dimensions: 75 × 75 mm
- max. VESA mounting dimensions: 900 × 600 mm
- distance from a wall: 38 mm
- max. load capacity (kg): 120
- dimensions: 995 × 625 × 38 mm
- packaging: 1 pc, paper box



**KT03F**

32 32 103 000

1/-/-/2

KT03F



www.emos.eu

Order Code  
Item Number

Packaging  
Type

- holder type: tilting
- screen diagonal: 26–65" (65–165 cm)
- min. VESA mounting dimensions: 75 × 75 mm
- max. VESA mounting dimensions: 400 × 400 mm
- tilt: +/-10°
- distance from a wall: 47,5 mm
- max. load capacity (kg): 60
- dimensions: 440 × 430 × 47,5 mm
- packaging: 1 pc, paper box



**KT01T**  
32 32 201 000

1/-/-/5  
KT01T

- holder type: tilting
- screen diagonal: 32–75" (81–191 cm)
- min. VESA mounting dimensions: 75 × 75 mm
- max. VESA mounting dimensions: 600 × 400 mm
- tilt: +/-10°
- distance from a wall: 47,5 mm
- max. load capacity (kg): 75
- dimensions: 640 × 430 × 47,5 mm
- packaging: 1 pc, paper box



**KT02T**  
32 32 202 000

1/-/-/5  
KT02T

- holder type: tilting
- screen diagonal: 42–85" (107–216 cm)
- min. VESA mounting dimensions: 75 × 75 mm
- max. VESA mounting dimensions: 700 × 500 mm
- tilt: +/-12°
- distance from a wall: 70 mm
- max. load capacity (kg): 100
- dimensions: 770 × 530 × 70 mm
- packaging: 1 pc, paper box



**KT03T**  
32 32 203 000

1/-/-/3  
KT03T

- holder type: console
  - screen diagonal: 26–60" (65–152 cm)
  - min. VESA mounting dimensions: 75 × 75 mm
  - max. VESA mounting dimensions: 400 × 400 mm
  - tilt: +/-8°
  - positioning: +/- 90°
  - distance from a wall: 55-390 mm
  - max. load capacity (kg): 30
  - dimensions: 420 × 420 × 390 mm
- = packaging: 1 pc, paper box

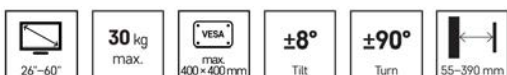

**KT01C**  
32 32 301 000

1/-/-/5  
KT01C

- holder type: console
  - screen diagonal: 42–85" (107–216 cm)
  - min. VESA mounting dimensions: 75 × 75 mm
  - max. VESA mounting dimensions: 600 × 400 mm
  - tilt: +/-10°
  - positioning: +/- 90°
  - distance from a wall: 80-400 mm
  - max. load capacity (kg): 45
  - dimensions: 640 × 430 × 400 mm
- = packaging: 1 pc, paper box



**KT02C**  
32 32 302 000

1/-/-/2  
KT02C

- holder type: console = packaging: 1 pc, paper box
- screen diagonal: 32-98" (81-249 cm)
- min. VESA mounting dimensions: 75 × 75 mm
- max. VESA mounting dimensions: 600 × 400 mm
- tilt: +/-5°
- positioning: +/- 90°
- distance from a wall: 80-650 mm
- max. load capacity (kg): 80
- dimensions: 680 × 420 × 650 mm

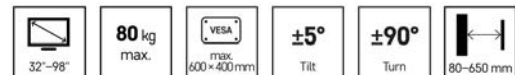

8 592920 153376

<b>KT03C</b>	1/-/-/1
32 32 303 000	KT03C

## Universal remote controllers OFA

- 100 % guaranteed compatibility with your devices
- controller pairs with most devices due to vast code database
- quality material manufacturing
- service support: +420 581 261 101/e-mail: oneforall@emos.cz

possible number of controlled devices: 2 = designed for: TV, DVB-T, SAT, KAB TV, IPTV = code search: manual = simple set settings = learning function = code remembered after removing the battery = range: 15 m = power source: 2× AAA = model line: Big Button = dimensions: 40 × 17 × 150 mm = weight: 220 g = packaging: 1 pc, small paper box



8 716 184 078323

<b>KE6821</b>	1/-/3/24
32 33 068 300	URC6821

possible number of controlled devices: 1 = designed for: TV Hisense = code search: readjustment of the code for a particular HISENSE line = learning function = code remembered after removing the battery = range: 15 m = power source: 2× AAA = model line: special TV = dimensions: 19 × 45 × 230 mm = weight: 80 g = packaging: 1 pc, small paper box



8 716 184 079641

<b>KE4916</b>	1/-/3/24
32 33 049 160	URC 4916

# Power supply extension cords, cable reels, plugs, accessories



## Power supply extension cords and sockets

### FRENCH Power supply extension cords and sockets

#### Single socket extension cords

### 1-phase 16A with PVC insulation

- 15–30 m extension cable with one socket
- conductor cross-section: 1.5 mm<sup>2</sup>, max. load: 3 680 W
- PVC insulation – ideal for the garage or workshop
- orange reflective colour – always visible to avoid tripping
- round socket, child socket covers

<p><b>PC0111</b>      1/5/-/20</p> <p>19 01 210 150      PC0111</p>     <ul style="list-style-type: none"> <li>▪ length: 1.5 m</li> <li>▪ number of sockets: 1× 2P + PE</li> <li>▪ maximum load: 3 680 W</li> <li>▪ conductor cross section: 1.0 mm<sup>2</sup></li> <li>▪ conductor: H05VV-F3G</li> <li>▪ type of insulation: PVC</li> </ul> <ul style="list-style-type: none"> <li>▪ children protection</li> <li>▪ packaging: 1 pc, foil</li> </ul>	<p><b>PC0113R</b>      1/5/-/20</p> <p>19 01 210 301      PC0113R</p>     <ul style="list-style-type: none"> <li>▪ length: 3 m</li> <li>▪ number of sockets: 1× 2P + PE</li> <li>▪ maximum load: 3 680 W</li> <li>▪ conductor cross section: 1.5 mm<sup>2</sup></li> <li>▪ conductor: H05VV-F3G</li> <li>▪ type of insulation: PVC</li> </ul> <ul style="list-style-type: none"> <li>▪ children protection</li> <li>▪ packaging: 1 pc, foil</li> </ul>
<p><b>PC0115R</b>      1/-/-/20</p> <p>19 01 210 500      PC0115R</p>     <ul style="list-style-type: none"> <li>▪ length: 5 m</li> <li>▪ number of sockets: 1× 2P + PE</li> <li>▪ maximum load: 3 680 W</li> <li>▪ conductor cross section: 1.5 mm<sup>2</sup></li> <li>▪ conductor: H05VV-F3G</li> <li>▪ type of insulation: PVC</li> </ul> <ul style="list-style-type: none"> <li>▪ children protection</li> <li>▪ packaging: 1 pc, foil</li> </ul>	<p><b>P01110</b>      1/-/-/10</p> <p>19 01 811 005      P01110</p>     <ul style="list-style-type: none"> <li>▪ length: 10 m</li> <li>▪ conductor cross section: 1.5 mm<sup>2</sup></li> <li>▪ voltage: 230 V</li> <li>▪ current: 16 A</li> <li>▪ IP rating: IP20</li> <li>▪ number of sockets: 1</li> </ul> <ul style="list-style-type: none"> <li>▪ thermal fuse: no</li> <li>▪ conductor: H05VV-F3G</li> <li>▪ max. unreeled load: 16 A max./3 680 W</li> <li>▪ children protection</li> <li>▪ packaging: 1 pc, packet</li> </ul>

## Two-cores PVC

- extension cable with one socket
- length: 1.5 or 5 m, PVC insulation – ideal for the interior
- conductor: 0.75 mm<sup>2</sup>, child socket covers

### PC01305

1/-/10/30

19 02 210 500

PC01305



8 592920 150986



- length: 5 m
- number of sockets: 1
- maximum load: 575 W
- conductor cross section: 0.75 mm<sup>2</sup>
- conductor: H03VVH2-F
- type of insulation: PVC

- children protection
- packaging: 1 pc, hanging

### PC01303

1/-/10/30

19 02 210 300

PC01303



8 592920 151013

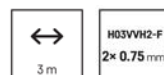

- length: 3 m
- number of sockets: 1
- maximum load: 575 W
- conductor cross section: 0.75 mm<sup>2</sup>
- conductor: H03VVH2-F
- type of insulation: PVC

- children protection
- packaging: 1 pc, hanging

### PC01301

1/-/10/60

19 02 210 150

PC01301



8 592920 151044



- length: 1.5 m
- number of sockets: 1
- maximum load: 575 W
- conductor cross section: 0.75 mm<sup>2</sup>
- conductor: H03VVH2-F
- type of insulation: PVC

- children protection
- packaging: 1 pc, hanging

# Power supply extension cords and sockets

## SCHUKO Power supply extension cords and sockets

### Single socket extension cords

#### 1-phase 16A with PVC insulation

- 2–30 m extension cable with one socket
- conductor cross section: 1.5 mm, max. load: 3 680 W
- PVC insulation - ideal for the garage or workshop
- orange reflective colour - always visible to avoid tripping
- round socket, child socket covers

<b>PC0121R</b> 19 21 210 150  8 592920 157752	1/5/-/20 PC0121R  1.5 m  H05VV-F3G 1.5 mm <sup>2</sup>		<b>PC0123R</b> 19 21 210 300  8 592920 157763	1/5/-/20 PC0123R  3 m  H05VV-F3G 1.5 mm <sup>2</sup>	
<ul style="list-style-type: none"> <li>▪ length: 1.5 m</li> <li>▪ number of sockets: 1× 2P + PE</li> <li>▪ voltage/current: 250 V~/16 A max.</li> <li>▪ maximum load: 3 680 W</li> <li>▪ type of insulation: PVC</li> <li>▪ conductor: H05VV-F3G 1.5 mm<sup>2</sup></li> </ul>	<ul style="list-style-type: none"> <li>▪ material of the sockets + plugs: plastic</li> <li>▪ packaging: 1 pc, foil+hanging</li> </ul>		<ul style="list-style-type: none"> <li>▪ length: 3 m</li> <li>▪ number of sockets: 1× 2P + PE</li> <li>▪ voltage/current: 250 V~/16 A max.</li> <li>▪ maximum load: 3 680 W</li> <li>▪ type of insulation: PVC</li> <li>▪ conductor: H05VV-F3G 1.5 mm<sup>2</sup></li> </ul>	<ul style="list-style-type: none"> <li>▪ material of the sockets + plugs: plastic</li> <li>▪ packaging: 1 pc, foil+hanging</li> </ul>	
<b>PC0125R</b> 19 21 210 501  8 592920 157794	1/-/-/20 PC0125R  5 m  H05VV-F3G 1.5 mm <sup>2</sup>		<b>P01210R</b> 19 21 811 005  8 592920 154458	1/-/-/10 P01210R  10 m  H05VV-F3G 1.5 mm <sup>2</sup>	
<ul style="list-style-type: none"> <li>▪ length: 5 m</li> <li>▪ number of sockets: 1× 2P + PE</li> <li>▪ voltage/current: 250 V~/16 A max.</li> <li>▪ maximum load: 3 680 W</li> <li>▪ type of insulation: PVC</li> <li>▪ conductor: H05VV-F3G 1.5 mm<sup>2</sup></li> </ul>	<ul style="list-style-type: none"> <li>▪ material of the sockets + plugs: plastic</li> <li>▪ packaging: 1 pc, foil+hanging</li> </ul>		<ul style="list-style-type: none"> <li>▪ length: 10 m</li> <li>▪ conductor cross section: 1.5 mm<sup>2</sup></li> <li>▪ voltage: 230 V</li> <li>▪ current: 16 A</li> <li>▪ IP rating: IP20</li> <li>▪ number of sockets: 1</li> </ul>	<ul style="list-style-type: none"> <li>▪ thermal fuse: no</li> <li>▪ conductor: H05VV-F3G</li> <li>▪ max. unreeled load: 16 A max./3 680 W</li> <li>▪ children protection</li> <li>▪ packaging: 1 pc, packet</li> </ul>	

# Surge protectors

## Surge protectors EMOS FRENCH

- extension cord with surge protector
- protects TV, satellite or laptop from power surges
- EMOS surge protectors have 3 or 6 sockets and 1,5-5 m lead
- max. load: 2 300 W
- black/white design, illuminated switch, child socket covers

- rated voltage: 250 V~, 50 Hz
- maximum load: 2 300 W
- conductor: H05VV-F3G 1.0 mm<sup>2</sup>
- energy absorption: 380 J L-N
- protection level Up: 1.3 kV (L/N)
- open-circuit voltage UOC: 6 kV (L/N)
- response time: 1 ns
- overload protection: yes, 10 A/ 250V~
- surge protector indicator

- dimensions: 233 × 53 × 40 mm
- packaging: 1 pc, box

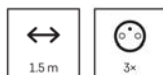
**P54013**

1/-/-/15

19 09 030 150

S9P339P

- rated voltage: 250 V~, 50 Hz
- maximum load: 2 300 W
- conductor: H05VV-F3G 1.0 mm<sup>2</sup>
- energy absorption: 380 J L-N
- protection level Up: 1.3 kV (L/N)
- open-circuit voltage UOC: 6 kV (L/N)
- response time: 1 ns
- overload protection: yes, 10 A/ 250V~
- surge protector indicator

- dimensions: 233 × 53 × 40 mm
- packaging: 1 pc, box

**P54014**

1/-/-/15

19 09 030 151

S9P339P

- rated voltage: 250 V~, 50 Hz
- maximum load: 2 300 W
- conductor: H05VV-F3G 1.0 mm<sup>2</sup>
- energy absorption: 380 J L-N
- protection level Up: 1.3 kV (L/N)
- open-circuit voltage UOC: 6 kV (L/N)
- response time: 1 ns
- overload protection: yes, 10 A/ 250V~
- surge protector indicator

- dimensions: 358 × 53 × 40 mm
- packaging: 1 pc, box

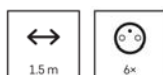
**P54015**

1/-/-/10

19 09 060 151

S9P631P



www.emos.eu

Order Code  
Item Number

Packaging  
Type

- rated voltage: 250 V~, 50 Hz
- maximum load: 2 300 W
- conductor: H05VV-F3G 1.0 mm<sup>2</sup>
- energy absorption: 380 J L-N
- protection level Up: 1.3 kV (L/N)
- open-circuit voltage UOC: 6 kV (L/N)
- response time: 1 ns
- overload protection: yes, 10 A/ 250V~
- surge protector indicator

- dimensions: 358 × 53 × 40 mm
- packaging: 1 pc, box

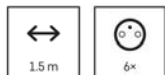

**P54018**  
19 09 060 152

1/-/-/10  
S9P631P

- rated voltage: 250 V~, 50 Hz
- maximum load: 2 300 W
- conductor: H05VV-F3G 1.0 mm<sup>2</sup>
- energy absorption: 380 J L-N
- protection level Up: 1.3 kV (L/N)
- open-circuit voltage UOC: 6 kV (L/N)
- response time: 1 ns
- overload protection: yes, 10 A/ 250V~
- surge protector indicator

- dimensions: 358 × 53 × 40 mm
- packaging: 1 pc, box

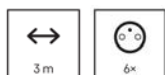

**P54016**  
19 09 060 301

1/-/-/10  
S9P631P

- rated voltage: 250 V~, 50 Hz
- maximum load: 2 300 W
- conductor: H05VV-F3G 1.0 mm<sup>2</sup>
- energy absorption: 380 J L-N
- protection level Up: 1.3 kV (L/N)
- open-circuit voltage UOC: 6 kV (L/N)
- response time: 1 ns
- overload protection: yes, 10 A/ 250V~
- surge protector indicator

- dimensions: 358 × 53 × 40 mm
- packaging: 1 pc, box

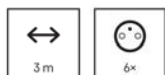

**P54019**  
19 09 060 302

1/-/-/10  
S9P631P

- rated voltage: 250 V~, 50 Hz
- maximum load: 2 300 W
- conductor: H05VV-F3G 1.0 mm<sup>2</sup>
- energy absorption: 380 J L-N
- protection level Up: 1.3 kV (L/N)
- open-circuit voltage UOC: 6 kV (L/N)
- response time: 1 ns
- overload protection: yes, 10 A/ 250V~
- surge protector indicator

- dimensions: 358 × 53 × 40 mm
- packaging: 1 pc, box



**P54017**  
19 09 060 500

1/-/-/10  
S9P631P

## Surge protectors EMOS SCHUKO

- extension cable with overvoltage protection
- protects TV, satellite or laptop from mains overvoltage
- black or white design, backlit switch & child socket covers

- rated voltage: 250 V~, 50 Hz
- maximum load: 2 300 W
- conductor: H05VV-F3G 1.5 mm<sup>2</sup>
- energy absorption: 380 J L-N
- protection level Up: 1.3 kV (L/N)
- open-circuit voltage UOC: 6 kV (L/N)
- response time: 1 ns
- overload protection: yes, 10 A/ 250V~
- surge protector indicator



- dimensions: 358 × 53 × 40 mm
- packaging: 1 pc, box



**P54219**  
19 09 060 304

1/-/-/10  
S9P615P

- rated voltage: 250 V~, 50 Hz
- maximum load: 2 300 W
- conductor: H05VV-F3G 1.5 mm<sup>2</sup>
- energy absorption: 380 J L-N
- protection level Up: 1.3 kV (L/N)
- open-circuit voltage UOC: 6 kV (L/N)
- response time: 1 ns
- overload protection: yes, 10 A/ 250V~
- surge protector indicator

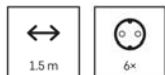

- dimensions: 358 × 53 × 40 mm
- packaging: 1 pc, box



**P54218**  
19 09 060 154

1/-/-/10  
S9P615P

- rated voltage: 250 V~, 50 Hz
- maximum load: 2 300 W
- conductor: H05VV-F3G 1.5 mm<sup>2</sup>
- energy absorption: 380 J L-N
- protection level Up: 1.3 kV (L/N)
- open-circuit voltage UOC: 6 kV (L/N)
- response time: 1 ns
- overload protection: yes, 10 A/ 250V~
- surge protector indicator



- dimensions: 358 × 53 × 40 mm
- packaging: 1 pc, box



**P54217**  
19 09 060 501

1/-/-/10  
S9P615P

- rated voltage: 250 V~, 50 Hz
- maximum load: 2 300 W
- conductor: H05VV-F3G 1.5 mm<sup>2</sup>
- energy absorption: 380 J L-N
- protection level Up: 1.3 kV (L/N)
- open-circuit voltage UOC: 6 kV (L/N)
- response time: 1 ns
- overload protection: yes, 10 A/ 250V~
- surge protector indicator

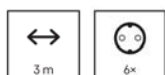

- dimensions: 358 × 53 × 40 mm
- packaging: 1 pc, box



**P54216**  
19 09 060 303

1/-/-/10  
S9P615P



www.emos.eu

Order Code  
Item Number

Packaging  
Type

- rated voltage: 250 V~, 50 Hz
- maximum load: 2 300 W
- conductor: H05VV-F3G 1.5 mm<sup>2</sup>
- energy absorption: 380 J L-N
- protection level Up: 1.3 kV (L/N)
- open-circuit voltage UOC: 6 kV (L/N)
- response time: 1 ns
- overload protection: yes, 10 A/ 250V~
- surge protector indicator

- dimensions: 358 × 53 × 40 mm
- packaging: 1 pc, box



**P54215**  
19 09 060 153

1/-/-/10  
S9P615P

- rated voltage: 250 V~, 50 Hz
- maximum load: 2 300 W
- conductor: H05VV-F3G 1.5 mm<sup>2</sup>
- energy absorption: 380 J L-N
- protection level Up: 1.3 kV (L/N)
- open-circuit voltage UOC: 6 kV (L/N)
- response time: 1 ns
- overload protection: yes, 10 A/ 250V~
- surge protector indicator

- dimensions: 233 × 53 × 40 mm
- packaging: 1 pc, box

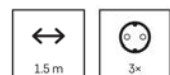

**P54214**  
19 09 030 153

1/-/-/15  
S9P338P

- rated voltage: 250 V~, 50 Hz
- maximum load: 2 300 W
- conductor: H05VV-F3G 1.5 mm<sup>2</sup>
- energy absorption: 380 J L-N
- protection level Up: 1.3 kV (L/N)
- open-circuit voltage UOC: 6 kV (L/N)
- response time: 1 ns
- overload protection: yes, 10 A/ 250V~
- surge protector indicator

- dimensions: 233 × 53 × 40 mm
- packaging: 1 pc, box

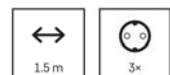

**P54213**  
19 09 030 152

1/-/-/15  
S9P338P

# Sockets, plugs, adaptors, timers, others

## Adaptors

- splitter sockets with 1–3 outlets, fitted with child covers
- enable connecting multiple devices into one socket
- max. load 3 680 W, IP20 enclosure
- for connecting devices with round or flat plugs
- with or without switch

### P0078

1/-/6/36

19 05 120 050

P0078



8 592920 151235

16 A



IP20



product: adapter plug 2x+1xUSB-A+1xUSB-C 5 V DC 3,4 A max. 17 W =  
voltage/current: 250 V~/16 A max. = maximum load: 3 680 W = children protection =  
IP rating: IP20 = material: plastic = packaging: 1 pc, hanging

## Travel adaptors

- travel aid for connecting to FRENCH and SCHUKO sockets
- often in the form of universal adapter w/ min. 5 plug types
- can be used in more than 150 world countries
- also with adapter w/ SCHUKO socket (used in DE, HU, SI etc.)
- max. current load of 10 or 16 A

### P0055E

1/-/10/50

19 10 001 000

1.500211C-E



8 592920 158838



designed for: for foreigners arriving in Europe and having a different plug type than  
SCHUKO or FRENCH = using: plugs (USA, GB, JP, CN, AU etc.) into the SCHUKO (DE, HU,  
SI etc.) or FRENCH (CZ, SK, PL) systems = packaging: 1 pc, small box

### P0055U

1/-/10/20

19 10 001 100

1.500295C-E



8 592920 158821



designed for: for foreigners arriving in Europe and having a different plug type than  
SCHUKO or FRENCH = using: plugs (USA, GB, JP, CN, AU etc.) into the SCHUKO (DE, HU,  
SI etc.) or FRENCH (CZ, SK, PL) systems = packaging: 1 pc, small box

**P0056U**

1/-/5/20

19 10 001 200

1.302474



8 592920 158845

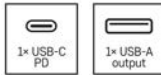

designed for: for Europeans travelling abroad = using: America, Asia, Australia, New Zealand, China, Great Britain, Hong Kong, India, etc. = packaging: 1 pc, small box

# HF signal receiving components, antennas, small electronic, accessories



## Accessories

### ZigBee GoSmart

- To expand the smart home with additional sensors and products
- Allows automation settings for added sensors and products
- Communication protocols Wi-Fi/Zigbee 3.0/BLE/SigMesh
- Compatibility with EMOS GoSmart products and TUYA devices



- product: IP gateway
  - connectivity: 2.4 GHz WIFI
  - maximum number of connected clients: 128
  - compatibility: EMOS GoSmart, TUYA, LIDL, Smartlife
  - protocol: Wi-Fi/Zigbee 3.0/BLE/SigMesh
  - pairing: automatic, manual
  - use: indoor
  - number of control buttons: 1
  - power supply: 5 V DC/1.0 A
- supported OS: Android, iOS



8 592920 156476

**H5002**

1/-/-/48

30 69 050 020

IP-2000Z



# Videophones, doorbells

## Home videophones, sets

## Videophones and video doorbells GoSmart



- Perfect access control for commercial and private properties
- Unusual activity alerts sent to mobile devices
- Two-way communication with the visitor without opening the door
- Automatic video and audio recording when motion is detected
- Night vision for perfect images in all lighting conditions
- Compatibility with EMOS GoSmart products and TUYA devices
- Voice control with Google Assistant and Amazon Alexa



product: doorphone set with WiFi = screen size: 7" = possibility to record = lock control = gate control = intercom = power supply for the screen: 24 V DC (BUS) = optional connection of CCTV camera = monitor size: 152 × 205 × 22 mm = dimensions of the camera unit: 125 × 235 × 35 mm = camera viewing angle: 170° = packaging: 1 pc, paper box = supported OS: Android, iOS = compatibility: EMOS GoSmart, TUYA, LIDL, Smartlife, Open system = protocol: Wi-fi = connectivity: 2.4 GHz WIFI = voice communication: twoWay = other function: unlocking via rfid chip or fingerprint, doorbell button



--	--	--	--	--	--	--	--	--	--



**H4080**  
30 10 040 800

1/-/-/4  
IP-880

product: video phone = screen size: 7" = lock and gate control: door lock, the gate rails = intercom = power supply for the monitor: 24 V DC (BUS) = recommended camera unit: H4082, H4083, H4084 = monitor size: 152 × 205 × 22 mm = packaging: 1 pc, box



--	--	--	--	--	--	--	--	--



**H4081**  
30 10 040 810

1/-/-/12  
IP-880B

product: camera unit for 1 user = number of buttons on the camera unit: 1 = power supply: 24 V DC (BUS) = number of wires (monitor/lock/power supply): 2 = dimensions of the camera unit: 125 × 235 × 35 mm = IP rating: IP44 = camera viewing angle: 170° = door lock control = installation: surface/surfaced = packaging: 1 pc, box



**H4082** 1/-/-/6  
30 10 040 820 IP-881

product: camera unit for 2 users = number of buttons on the camera unit: 2 = power supply: 24 V DC (BUS) = number of wires (monitor/lock/power supply): 2 = dimensions of the camera unit: 125 × 235 × 35 mm = IP rating: IP44 = camera viewing angle: 170° = door lock control = installation: surface/surfaced = packaging: 1 pc, box



**H4083** 1/-/-/6  
30 10 040 830 IP-882

product: camera unit for 3 users = number of buttons on the camera unit: 3 = power supply: 24 V DC (BUS) = number of wires (monitor/lock/power supply): 2 = dimensions of the camera unit: 125 × 235 × 35 mm = IP rating: IP44 = camera viewing angle: 170° = door lock control = installation: surface/surfaced = packaging: 1 pc, box



**H4084** 1/-/-/6  
30 10 040 840 IP-883

## Home videophones

- part of modern household security
- kit consists of camera and monitor with intuitive controls
- expandable with extra inputs, screens or CCTV cameras
- gate control from inside the house, touch/mechanical keys
- higher class videophones also w/ photographic memory/Wi-Fi
- white or infrared camera illumination ensures night vision
- colour display, up to 16 ringtones, power supply included

- product: video set
- screen size: 7
- lock control
- gate control
- power supply for the screen: 230 V/50 Hz
- monitor size: 125 × 185 × 25 mm
- dimensions of the camera unit: 150 × 60 × 40 mm
- camera viewing angle: 120°
- packaging: 1 pc, paper box



**H2060** 1/-/-/6  
30 10 002 060 EM-04Z

- product: video set
- screen size: 7"
- lock control
- power supply for the screen: 12 V / 2 A DC (include)
- monitor size: 179 × 126 × 18 mm
- dimensions of the camera unit: 155 × 55 × 40 mm
- camera viewing angle: 120°
- packaging: 1 pc, box
- voice communication: twoWay



**H2020** 1/-/-/8  
30 10 002 020 EM-LS07Q

## Cameras, Surveillance

### GoSmart Cameras



- For keeping people safe and protecting the interiors of homes
- Surveillance of exteriors of commercial and private buildings
- Alerts of unusual activity sent to mobile devices
- Two-way voice communication
- Automatic video and audio recording when motion is detected
- Connection to home network via WIFI protocol
- Compatibility with EMOS GoSmart products and TUYA devices
- Voice control with Google Assistant and Amazon Alexa

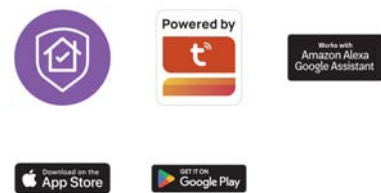

- automatic image saving
- setting the detection area
- night vision
- camera viewing angle: 180°
- IP rating: IP21
- camera resolution: 2 560 × 1 440
- motion detection
- sound detection
- compatibility: EMOS GoSmart, TUYA, LIDL, Smartlife
- protocol: Wi-Fi
- transmission frequency: 2.4 GHz/5 GHz Dual Band
- voice communication: twoWay
- motion tracking
- motorised rotation
- motion detection angle: 120°
- motion detection range: 10 meters
- human body recognition



**H4062** 1/-/-/18  
30 24 040 620 IP-220W

- automatic image saving
- setting the detection area
- night vision
- camera viewing angle: 135°
- IP rating: IP44
- camera resolution: 2 880 × 1 620
- motion detection
- sound detection
- compatibility: EMOS GoSmart, TUYA, LIDL, Smartlife
- protocol: Wi-Fi
- transmission frequency: 2.4 GHz WIFI
- voice communication: twoWay
- motion tracking
- motorised rotation
- motion detection angle: 135°
- motion detection range: 9 metres
- human body recognition



**H4067** 1/-/-/9  
30 24 040 670 IP-1200



www.emos.eu

Order Code  
Item Number

Packaging  
Type

- automatic image saving
- setting the detection area
- night vision
- camera viewing angle: 180°
- IP rating: IP21
- camera resolution: 2 560 × 1 440
- motion detection
- sound detection
- compatibility: EMOS GoSmart, TUYA, LIDL, Smartlife

- protocol: Wi-Fi
- transmission frequency: 2.4 GHz/5 GHz Dual Band
- voice communication: two-way
- motion tracking
- motorised rotation
- motion detection angle: 120°
- motion detection range: 10 meters
- human body recognition



**H4072** 1/-/-18  
30 24 040 720 IP-220G

- automatic image saving
- setting the detection area
- night vision
- camera viewing angle: 135°
- IP rating: IP44
- camera resolution: 2 880 × 1 620
- motion detection
- sound detection
- compatibility: EMOS GoSmart, TUYA, LIDL, Smartlife

- protocol: Wi-Fi
- transmission frequency: 2.4 GHz WIFI
- voice communication: two-way
- motion detection angle: 135°
- motion detection range: 9 metres
- human body recognition



**H4073** 1/-/-12  
30 24 040 730 IP-1150

- automatic image saving
- setting the detection area
- night vision
- camera viewing angle: 110°
- IP rating: IP44
- camera resolution: 2 560 × 1 440
- motion detection
- compatibility: EMOS GoSmart, TUYA, LIDL, Smartlife
- protocol: Wi-Fi

- transmission frequency: 2.4 GHz/5 GHz Dual Band
- voice communication: two-way
- motion tracking
- motorised rotation
- motion detection angle: 100°
- motion detection range: 10 meters
- human body recognition



**H4074** 1/-/-2  
30 24 040 740 IP-1300

# Cameras, Surveillance

## Alarms

### Alarms GoSmart



- Reliable protection of property against unauthorized access
- Smart motion detection with adjustable sensitivity
- Control and notifications via mobile app (Android/iOS)
- Flexible power supply and easy installation
- Connection to home network via WiFi and RF
- Compatibility with EMOS GoSmart products and TUYA devices
- Voice control with Google Assistant and Amazon Alexa



- product: alarm
  - detection angle: 110°
  - detection distance: 8 m
  - switching time: 5 s, 30 s, 1 min, 3 min, 5 min, 8 min
  - IP rating: IP21
  - sensor type: PIR
  - power source: DC USB 5 V / 3× AA
  - packaging: 1 pc, paper box
  - supported OS: Android, iOS
- compatibility: EMOS GoSmart, TUYA, LIDL, Smartlife,
  - protocol: Wi-Fi, RF
  - transmission frequency: 2.4 GHz WIFI (IEEE802.11b/
  - notifications to the mobile app
  - application languages: EN, CZ, SK, PL, DE, HU, SI, FR,



--	--	--	--	--	--	--	--	--	--



**H530** 1/-/-12  
30 69 050 300 EM-126L

### Alarms

- reliable protection of property against unauthorized entry
- motion detection when doors/windows are opened or glass is brok
- remote control with activation, deactivation, and SOS functions
- loud siren to deter intruders and alert surroundings
- easy installation, ideal for homes and offices

- mounting type: #
  - mounting hole: #
  - product: alarm
  - detection angle: 110°
  - detection distance: 8 m
  - switching time: 5 s, 30 s, 1 min, 3 min, 5 min, 8 min
  - IP rating: IP21
  - sensor type: PIR
  - power source: DC USB 5 V / 3× AA
- packaging: 1 pc, paper box
  - protocol: RF



--	--	--	--	--	--	--	--



**H8106** 1/-/-24  
30 81 000 010 EM-125L

# Multimeters, testers



## Multimeters, measuring cables

- multimeters measure electrical quantities – voltage, etc.
- automatic or manual measurement range selection
- also measure temperature and allow diode or transistor tests
- clamp multimeter for higher values, w/o circuit interruption
- plus spare measuring leads with tips, for any multimeter

AC voltage: 200–600 V = AC current: 200 mA – 10 A = DC voltage: 2–600 V = DC current: 200 mA – 10 A = screen display: 3.5 digit = backlight display = range selection: manual = electrical resistance: 200 Ohm – 2 MOhm = circuit continuity = diode test = battery test: 1.5 V/9 V = temperature measurement: -40 °C to +300 °C = Data hold mode = auto power off = included: battery, manual, measurement tips, temperature probe = power source: 3× 1.5 V AAA (included) = dimensions: 35 × 75 × 155 mm

**M0230N**

1/-/-/16

22 02 022 000

MD-230

AC voltage: 600 mV – 750 V = AC current: 600 µA–10 A = DC voltage: 600 mV – 1 000 V = DC current: 600 µA–10 A = screen display: 5 3/4 digit = backlight display = range selection: both automatic and manual = electrical resistance: 600 Ohm – 60 MOhm = circuit continuity = diode test = transistor test = temperature measurement: -40 °C to +300 °C = max. value hold = Data hold mode = auto power off = included: battery, measurement tips, reduction for measuring transistors, temperature probe type K = power source: 1× 9 V (included) = dimensions: 35 × 90 × 190 mm

**M0430N**

1/-/-/10

22 02 023 000

MD-430

AC voltage: 2–600 V = AC current: 200 µA – 200 mA = DC voltage: 200 mV – 600 V = DC current: 200 µA – 200 mA = screen display: 3 1/2 digit = backlight display = range selection: automatic = electrical resistance: 200 Ohm – 20 MOhm = circuit continuity = diode test = max. value hold = Data hold mode = auto power off = included: battery, manual, measurement tips = power source: 2× 1.5 V AAA (included) = dimensions: 44 × 38 × 230 mm

**M3216N**

1/-/-/24

22 02 024 000

MD-300

AC voltage: 200–300 V = DC voltage: 200 mV – 300 V = DC current: 20 mA – 10 A = screen display: 3.5 digit = backlight display = range selection: manual = electrical resistance: 200 Ohm – 2 MOhm = circuit continuity = diode test = battery test = Data hold mode = included: battery, manual, measurement tips = power source: 1× 9 V (included) = dimensions: 150 × 75 × 35 mm

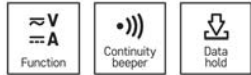

**M3620N**

1/-/-/18

22 02 025 000

MD-310

AC voltage: 200 mV – 300 V = AC current: 20 mA – 10 A = DC voltage: 200 mV – 300 V = DC current: 20 mA – 10 A = screen display: 3.5 digit = backlight display = range selection: manual = non-contact AC voltage detection = electrical resistance: 200 Ohm – 20 MOhm = circuit continuity = diode test = battery test = temperature measurement: 0 °C to +1 000 °C = Data hold mode = included: battery, manual, measurement tips = power source: 1× 9 V (included) = dimensions: 168 × 83 × 35 mm



**M3691N**

1/-/-/12

22 02 026 000

EM3691

AC voltage: 2–600 V = AC current: 2–600 A = DC voltage: 200 mV – 600 V = clamp multimeter = screen display: 3.5 digit = range selection: automatic = electrical resistance: 200 Ohm – 20 MOhm = circuit continuity = diode test = Data hold mode = auto power off = included: battery, manual, measurement tips = power source: 2× 3 V CR2032 (included) = dimensions: 36 × 76 × 190 mm



**M0305N**

1/-/-/18

22 02 027 000

MD-310C

AC voltage: 4–600 V = AC current: 400 A = DC voltage: 400 mV – 600 V = DC current: 400 A = clamp multimeter = screen display: 3 3/4 digit = range selection: automatic = electrical resistance: 400 Ohm – 40 MOhm = circuit continuity = diode test = temperature measurement: -20 °C to +1 000 °C = Data hold mode = auto power off = included: battery, manual, measurement tips = power source: 2× 1.5 V AAA (included) = dimensions: 38 × 71 × 194 mm



**M0400N**

1/-/-/12

22 02 028 000

MD-410C

AC voltage: 200–300 V = DC voltage: 200 mV – 300 V = DC current: 2 000 µA – 200 mA = screen display: 3.5 digit = range selection: manual = electrical resistance: 200 Ohm – 2 MOhm = diode test = battery test: 1.5 V/9 V = included: battery, manual, measurement tips = power source: 1× 12 V (included) = dimensions: 30 × 57 × 95 mm



**M0320N**

1/-/-/32

22 02 029 000

MD-110



www.emos.eu

Order Code  
Item Number

Packaging  
Type

AC voltage: 200–300 V = DC voltage: 200 mV – 300 V = DC current: 20  $\mu$ A – 10 A = screen display: 3.5 digit = range selection: manual = electrical resistance: 200 Ohm – 2 MOhm = circuit continuity = diode test = included: battery, manual, measurement tips, protective case = power source: 1  $\times$  9 V (included) = dimensions: 27  $\times$  70  $\times$  135 mm



**M0391N**

1/-/-/24

22 02 030 000

MD-210



AC voltage: 2–300 V = AC current: 200  $\mu$ A – 10 A / with pliers up to 1 000 A (not included) = DC voltage: 200 mV – 300 V = DC current: 200  $\mu$ A – 10 A / with pliers up to 1 000 A (not included) = screen display: 3.5 digit = backlight display = range selection: automatic = electrical resistance: 200 Ohm – 20 MOhm = circuit continuity = diode test = transistor test = temperature measurement: -20  $^{\circ}$ C to +1 000  $^{\circ}$ C = max. value hold = Data hold mode = auto power off = included: battery, test leads, reduction for measuring transistors, temp. probe type K, lock the battery cover = power source: 3  $\times$  1.5 V AAA (included) = dimensions: 35  $\times$  75  $\times$  158 mm



**M0420N**

1/-/-/12

22 02 031 000

MD-420



AC voltage: 2–600 V = AC current: 2 mA – 10 A = DC voltage: 200 mV – 600 V = DC current: 2 mA – 10 A = screen display: 3.5 digit = range selection: manual = electrical resistance: 200 Ohm – 20 MOhm = circuit continuity = diode test = transistor test = included: battery, manual, measurement tips = power source: 1  $\times$  9 V (included) = dimensions: 32  $\times$  85  $\times$  165 mm



**M2092N**

1/-/5/20

22 02 032 000

MD-220



cable length: 95 cm = maximum load: 1 A, 30 V AC, 60 V DC = possibility to tips exchange = colour: red, black = packaging: 1 pc, small box



**S4001R**

1/-/-/80

23 04 000 400

S4001R

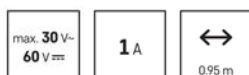

cable length: 95 cm = maximum load: 10 A, 1 kV, CAT III = colour: red, black = packaging: 1 pc, small box



**S4003N**

1/-/-/40

23 04 000 500

BB58

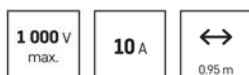

## Testers

- voltage tester for measuring voltage value
- also identifies phases, sequence and polarity
- detects DC and AC voltage, contact or non-contact
- results indicated optically and acoustically

DC voltage: 0 to 250 V contactless = AC voltage: 70 to 250 V contactless = AC/DC voltage: 0-250 V, 70-250 V = polarity indication = non-contact measuring: polarity of sources and short-circuit, microwave ovens monitors emission = signalization: optical = power source: 2× 1.5 V LR41 (included) = frequency range: 0-60 Hz = packaging: 1 pc, header card



**M0018N** 1/-/24/96  
22 01 020 000 VT-110

DC voltage: 0 to 250 V contactless = AC voltage: 70 to 250 V contactless = AC/DC voltage: 0-250 V, 70-250 V = polarity indication = non-contact measuring: polarity of sources and short-circuit, microwave ovens monitors emission = two settings of sensitivity = signalization: optical + acoustic = power source: 2× 1.5 V LR44 (included) = frequency range: 0-60 Hz = packaging: 1 pc, box



**M0048N** 1/-/12/72  
22 01 021 000 VT-120

DC voltage: 12-690 V = AC voltage: 12-690 V = AC/DC voltage: 12 V, 24 V, 50 V, 120 V, 230 V, 400 V, 690 V = polarity indication = phase indication = signalization: optical + acoustic = power source: 9 V (included) = frequency range: 0-60 Hz = measuring of connections of circuits = packaging: 1 pc, box

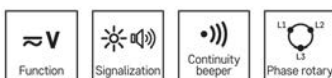

**M0012AN** 1/-/9/36  
22 01 022 000 VT-320

DC voltage: 110-400 V = AC voltage: 110-400 V = AC/DC voltage: 110 V, 230 V, 400 V = polarity indication = phase indication = signalization: optical = power source: from power source = frequency range: 0-60 Hz = packaging: 1 pc, box



**M0014AN** 1/-/9/36  
22 01 023 000 VT-310

DC voltage: 6–400 V = AC voltage: 6–400 V = AC/DC voltage: 6 V, 12 V, 24 V, 50 V, 120 V, 230 V, 400 V = polarity indication = signalization: optical = power source: from power source = frequency range: 0–60 Hz = packaging: 1 pc, box



**M0003BN** 1/-/-/40  
22 01 024 000 VT-211

DC voltage: 6–690 V = AC voltage: 6–690 V = AC/DC voltage: 6 V, 12 V, 24 V, 50 V, 120 V, 230 V, 400 V, 690 V = polarity indication = phase indication = signalization: optical + acoustic = power source: 2× 1.5 V AAA (included) = frequency range: 45–65 Hz = measuring of connections of circuits = packaging: 1 pc, box



**M0071N** 1/-/-/12  
22 01 025 000 VT-710

detection: AC wiring = signalization: optical + acoustic = AC voltage: 70–1 000 V = dimensions: 153 × 22 mm = power source: 2× 1.5 V AAA (included) = packaging: 1 pc, box



**M0007AN** 1/-/-/50  
22 05 000 020 VT-150

DC voltage: 12–250 V = AC voltage: 12–230 V = AC/DC voltage: 12–250 V = non-contact measuring = signalization: optical = power source: from power source = frequency range: 50–500 Hz = packaging: 1 pc, header card



**M0049N** 1/-/24/96  
22 01 026 000 VT-121

## Measuring instruments

- multidetector maps electrical wiring – no more drilled wires
- laser range finder calculates distance, area and room volume
- non-contact voltage detector for AC voltage up to 1 000 V

measuring functions: temperature = measuring units: °C/°F = temperature range: -50 °C to 550 °C = power source: 2× 1.5 V AAA (included) = packaging: 1 pc, small box

**M0503N**

1/-/-/50

22 06 000 040

M0503N

detection: wood, metal, AC wiring = signalization: optical + acoustic = dimensions: 28 × 72 × 155 mm = power source: 1× 9 V (included) = packaging: 1 pc, box

**M0501N**

1/-/-/20

22 06 000 050

M0501N

# Thermostats, CO and smoke alarms



## Thermostats

### Thermostats GoSmart



- Reduce heating/cooling costs for buildings
- Individual temperature settings for different rooms
- Set temperature scenarios for specific day and time
- Control all settings from anywhere using the app
- Heating or air conditioning control based on GPS location
- Connection via WIFI or Zigbee protocols
- Compatibility with EMOS GoSmart products and TUYA devices
- Voice control with Google Assistant and Amazon Alexa

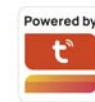

thermostat type: wireless with OpenTherm communication = type of control: programmable electronic room thermostat, option to control via mobile phone (iOS, Android) = backlight display = control mode: heating and cooling system = number of programs: 6 + 3 customizable for users = temperature adjustment type: comfort and economy temperature = temperature measurement: 0 °C to 40 °C, resolution 0.1 °C = temperature adjustment: from 7 °C up to 30 °C, after 0.2 °C = anti-frost protection = ON/OFF function = switching: 230 V AC or potential-free = switching load: 16 A resistive, 5 A inductive = power of transmitter: 5 V USB adapter (included) = power of receiver: 230 V AC = receiver's dimension: 115 × 37 × 91 mm = transmitter's dimension: 98 × 55 × 98 mm



**P56S11** 1/-/-8  
21 01 310 000 P56S11

thermostat type: wired with OpenTherm communication + underfloor heating = type of control: programmable electronic room thermostat, option to control via mobile phone (iOS, Android) = backlight display = control mode: heating and cooling system = number of programs: 6 + 3 customizable for users = temperature adjustment type: comfort and economy temperature = temperature measurement: 0 °C to 40 °C, resolution 0.1 °C = temperature adjustment: from 7 °C up to 30 °C, after 0.2 °C = anti-frost protection = ON/OFF function = switching: 230 V AC or potential-free = switching load: 16 A resistive, 5 A inductive = power source: 230 V AC = dimensions: 98 × 37 × 98 mm = part of the package: thermostat, floor sensor 3 m, Ø 8 mm



**P56S01** 1/-/-16  
21 01 213 000 P56S01

thermostat type: wired with OpenTherm communication + underfloor heating, coealed = type of control: programmable electronic room thermostat, option to control via mobile phone (iOS, Android) = backlight display = control mode: heating and cooling system = number of programs: 6 + 3 customizable for users = temperature adjustment type: comfort and economy temperature = temperature measurement: 0 °C to 40 °C, resolution 0.1 °C = temperature adjustment: from 7 °C up to 30 °C, after 0.2 °C = anti-frost protection = ON/OFF function = switching: 230 V AC or potential-free = switching load: 16 A resistive, 5 A inductive = power source: 230 V AC = dimensions: 98 × 37 × 98 mm = part of the package: thermostat, floor sensor 3 m, Ø 8 mm



**P56S01F** 1/-/-/16  
21 01 212 000 P56S01F

thermo shut-off valve: SMART, programmable = number of programs: 1 customisable programme or customisable temperature (6× per day) = temperature adjustment type: 6 temperature changes per day = temperature measurement: 0 °C to 40 °C, resolution 0.1 °C = temperature adjustment: 5 °C to 30 °C, resolution 0.5 °C = anti-frost protection = open window function = child lock = matrix: M30 × 1.5 mm = enclosed adaptors: RAV, RA, RAVL, Giacomini, Caleffi, M28 × 1.5 mm = power source: 2× 1.5 V AA (included) = dimensions: 53 × 53 × 90.5 mm = packaging: 1 pc, small box

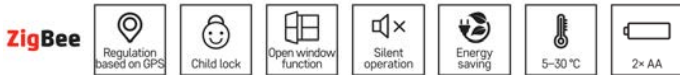

**P5631S** 1/-/8/32  
21 01 900 017 P5631S

## Thermostats

- indoor thermostats regulate heating systems & cooling units
- manual and digital, with programmable heating cycle
- wireless, wired and clamp-on
- often with backlit display and always with freeze protection

thermostat type: wireless with OpenTherm communication = type of control: programmable electronic indoor thermostat = backlight display = control mode: heating and cooling system = number of programs: 6 + 3 customizable for users = temperature adjustment type: comfort and economy temperature = temperature measurement: 0 °C to 40 °C, resolution 0.1 °C = temperature adjustment: from 7 °C up to 30 °C, after 0.2 °C = anti-frost protection = ON/OFF function = switching: 230 V AC or potential-free = switching load: 16 A resistive, 5 A inductive = power of transmitter: 2× 1.5 V AA (included) or 5 V USB adapter (not included) = power of receiver: 230 V AC = receiver's dimension: 115 × 37 × 91 mm = transmitter's dimension: 98 × 55 × 98 mm



**P56A11** 1/-/-/8  
21 01 311 000 P56A11

thermostat type: wired with OpenTherm communication + underfloor heating = type of control: programmable electronic indoor thermostat = backlight display = control mode: heating and cooling system = number of programs: 6 + 3 customizable for users = temperature adjustment type: comfort and economy temperature = temperature measurement: 0 °C to 40 °C, resolution 0.1 °C = temperature adjustment: from 7 °C up to 30 °C, after 0.2 °C = anti-frost protection = ON/OFF function = switching: 230 V AC or potential-free = switching load: 16 A resistive, 5 A inductive = power source: 230 V AC = dimensions: 98 × 37 × 98 mm = part of the package: thermostat, floor sensor 3 m, Ø 8 mm



**P56A01** 1/-/-/16  
21 01 211 000 P56A01

thermostat type: wired with OpenTherm communication = type of control: programmable electronic indoor thermostat = backlight display = control mode: heating and cooling system = number of programs: 6 + 3 customizable for users = temperature adjustment type: comfort and economy temperature = temperature measurement: 0 °C to 40 °C, resolution 0.1 °C = temperature adjustment: from 7 °C up to 30 °C, after 0.2 °C = anti-frost protection = ON/OFF function = switching: 230 V AC or potential-free = switching load: 8 A resistively, 2 A inductively = power source: 2× 1.5 V AA (included) = transmitter's dimension: 98 × 31 × 98 mm



**P56A02** 1/-/-/16  
21 01 214 000 P56A02

thermostat type: wire = type of control: manual indoor thermostat = backlight display = control mode: heating and cooling system = number of programs: user adjustable temperature = temperature adjustment type: manually = temperature measurement: 0 °C to 40 °C, resolution 0.1 °C = temperature adjustment: from 5 °C up to 35 °C, after 0.5 °C = anti-frost protection = ON/OFF function = switching: 230 V AC or potential-free = switching load: 6 A resistive, 2 A inductive = power source: 2× 1.5 V AA (included) = dimensions: 93 × 28 × 93 mm



**P5608** 1/-/-/27  
21 01 111 000 P5608

thermostat type: wireless = type of control: manual indoor thermostat = backlight display = control mode: heating and cooling system = number of programs: user adjustable temperature = temperature adjustment type: manually = temperature measurement: 0 °C to 40 °C, resolution 0.1 °C = temperature adjustment: from 5 °C up to 35 °C, after 0.5 °C = anti-frost protection = ON/OFF function = switching: 230 V AC or potential-free = switching load: 16 A resistive, 4 A inductive = power of transmitter: 2× 1.5 V AA (included) = power of receiver: 230 V AC = receiver's dimension: 87 × 37 × 87 mm = transmitter's dimension: 93 × 67 × 109 mm



**P5618** 1/-/-/12  
21 01 112 000 P5618

# Detectors

## CO and smoke detectors

- life investment for families w/ gas boiler/cooker/fireplace
- CO detector identifies carbon monoxide (invisible, odorless)
- smoke detector alerts to potential fires in the household
- EMOS detector with 10 year service life

- detection type: smoke detector
- type of installation: possible to mount on the wall o
- type of signaling: optical and audible
- operating temperature: 0 °C to 40 °C
- operating humidity: 5–95 %
- lifetime: 10 years
- power source: 1× 9 V, included
- packaging: 1 pc, small box

**10**  
YEARS

8 592920 153130

**P56503X**

21 04 107 000

1/-/-/12

TSS910B



# Installation material, tapes

## Installation material

### Sockets, switches

#### EMOS

### IP54/IP44

- installation: onto a wall
- enclosure: IP44
- double socket is internally interconnected

**A1396.3**

1/5/-/25

19 50 010 207

EF602GV



8 592920 148884



product: double socket with earthing pins and lids with interconnection = design: German socket type = voltage: 250 V~ = type of mounting: on the wall = version: double water-resistant – vertical mounting = IP rating: IP44 = colour: grey-black = packaging: 1 pc, PE packet

**A1396.4**

1/5/-/25

19 50 010 208

EF600SAGV



8 592920 148914



product: combination of alternating switch nr.6 and socket with earthing pin and lid = design: German socket type = voltage: 250 V~ = type of mounting: on the wall = version: double water-resistant – vertical mounting = IP rating: IP44 = colour: grey-black = packaging: 1 pc, PE packet

# Modules GoSmart



- Remote control of connected devices
- Integration into home automation
- Variants for connection with or without the need for a neutral wire
- Easy installation under original switches
- Connection to the home network via WIFI/ZigBee protocol
- Compatibility with EMOS GoSmart products and TUYA devices
- Voice control with Google Assistant and Amazon Alexa



- product: IP switching module
  - connectivity: ZigBee 2.4 GHz
  - compatibility: EMOS GoSmart, TUYA, LIDL, Smartlife
  - control by voice assistants
  - protocol: Zigbee 3.0
  - pairing: automatic, manual
  - use: indoor
  - number of control buttons: 1
  - power supply: 230 V~/50 Hz, max. 0,3 W
- supported OS: Android, iOS



**H5121**

1/-/-/90

30 69 051 210

IP-2201SZ

- product: IP switching module
  - connectivity: 2.4 GHz WIFI
  - compatibility: EMOS GoSmart, TUYA, LIDL, Smartlife
  - control by voice assistants
  - protocol: Wi-Fi
  - pairing: automatic, manual
  - use: indoor
  - number of control buttons: 1
  - power supply: 230 V~/50 Hz, max. 0,3 W
- supported OS: Android, iOS



**H5125**

1/-/-/90

30 69 051 250

IP-2201SW

- product: IP switching module
  - connectivity: 2.4 GHz WIFI
  - compatibility: EMOS GoSmart, TUYA, LIDL, Smartlife
  - control by voice assistants
  - protocol: Wi-Fi
  - pairing: automatic, manual
  - use: indoor
  - number of control buttons: 1
  - power supply: 230 V~/50 Hz, max. 0,3 W
- supported OS: Android, iOS



**H5126**

1/-/-/90

30 69 051 260

IP-2202SW

- product: IP dimming module
  - connectivity: 2.4 GHz WIFI
  - compatibility: EMOS GoSmart, TUYA, LIDL, Smartlife
  - control by voice assistants
  - protocol: Wi-Fi
  - pairing: automatic, manual
  - use: indoor
  - number of control buttons: 1
  - power supply: 230 V~/50 Hz, max. 0,3 W
- supported OS: Android, iOS



**H5127**

1/-/-/90

30 69 051 270

IP-2211DW



www.emos.eu

Order Code  
Item Number

Packaging  
Type

- product: IP dimming module
  - connectivity: 2.4 GHz WIFI
  - compatibility: EMOS GoSmart, TUYA, LIDL, Smartlife
  - control by voice assistants
  - protocol: Wi-Fi
  - pairing: automatic, manual
  - use: indoor
  - number of control buttons: 1
  - power supply: 230 V~/50 Hz, max. 0,3 W
- = supported OS: Android, iOS



**H5128**

1/-/-90

30 69 051 280

IP-2212DW



- product: IP motor module
  - connectivity: 2.4 GHz WIFI
  - compatibility: EMOS GoSmart, TUYA, LIDL, Smartlife
  - control by voice assistants
  - protocol: Wi-Fi
  - pairing: automatic, manual
  - use: indoor
  - number of control buttons: 1
  - power supply: 230 V~/50 Hz, max. 0,3 W
- = supported OS: Android, iOS



**H5129**

1/-/-90

30 69 051 290

IP-2121CW



- product: IP garage module
  - connectivity: 2.4 GHz WIFI
  - compatibility: EMOS GoSmart, TUYA, LIDL, Smartlife
  - control by voice assistants
  - protocol: Wi-Fi
  - pairing: automatic, manual
  - use: indoor
  - number of control buttons: 1
  - power supply: 230 V~/50 Hz, max. 0,3 W
- = supported OS: Android, iOS



**H5131**

1/-/-30

30 69 051 310

IP-2231SW



- product: IP module NO / NC / COM
  - connectivity: 2.4 GHz WIFI
  - compatibility: EMOS GoSmart, TUYA, LIDL, Smartlife
  - control by voice assistants
  - protocol: Wi-Fi
  - pairing: automatic, manual
  - use: indoor
  - number of control buttons: 1
  - power supply: 230 V~/50 Hz, max. 0,3 W
- = supported OS: Android, iOS



**H5132**

1/-/-90

30 69 051 320

IP-2241DCW



# Installation material

## Sockets, switches

### EMOS

#### CYKLONE

- option for horizontal and vertical mounting
- flexible seal ensuring tightness
- cable passage for easy connection of cable or socket
- side hole for condensate drainage
- flexible edge around the perimeter to adapt to wall irregularities
- reinforcing edge around the mounting area to improve tightness

**D730423**

1/5/-/80

19 50 730 423

730483





- product: double two-way switch 6+6 (5)
- design: Cyklone
- voltage: 250 V~/10 AX
- type of mounting: on the wall
- version: 2 buttons, water-resistant
- IP rating: IP55
- colour: grey
- packaging: 1 pc

# Installation material

## Terminal blocks

- terminal blocks with brass contacts
- conductor diameter: 12×4mm<sup>2</sup>, 12×6mm<sup>2</sup>, 12×10mm<sup>2</sup>, 12×16mm<sup>2</sup>
- rated current: 32 A, 41 A, 57 A or 76 A

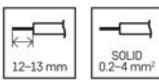

**A9101**      10/-/-/2,400  
31 14 991 010      SCL-02

**10×**

product: non screw clip = for conductor cross-section: 0.2–4 mm<sup>2</sup> = current: 32 A = rated voltage: 450 V~ = packaging: 10 pcs, small box = dimensions: 13.2 × 20.1 × 9.2 mm = UV protection: no = working temperature range: -10°C – 85°C = complies with: EN 60998-2-2:2004; EN 60998-1:2004 = self-extinguishing: EN 60695-2-11 (850°C) = insulation voltage: EN 60998-2-1 (250 V)

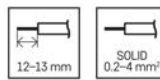

**A9102**      10/-/-/2,000  
31 14 991 020      SCL-03

**10×**

product: non screw clip = for conductor cross-section: 0.2–4 mm<sup>2</sup> = current: 32 A = rated voltage: 450 V~ = packaging: 10 pcs, small box = dimensions: 18.8 × 20.1 × 9.2 mm = UV protection: no = working temperature range: -10°C – 85°C = complies with: EN 60998-2-1:2004; EN 60998-1:2004 = self-extinguishing: EN 60695-2-11 (850°C) = insulation voltage: EN 60998-2-1 (250 V)

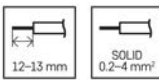

**A9103**      10/-/-/1,600  
31 14 991 030      SCL-04

**10×**

product: non screw clip = for conductor cross-section: 0.2–4 mm<sup>2</sup> = current: 32 A = rated voltage: 450 V~ = packaging: 10 pcs, small box = dimensions: 24.4 × 20.1 × 9.2 mm = UV protection: no = working temperature range: -10°C – 85°C = complies with: EN 60998-2-1:2004; EN 60998-1:2004 = self-extinguishing: EN 60695-2-11 (850°C) = insulation voltage: EN 60998-2-1 (250 V)

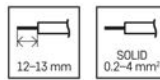

**A9104**      10/-/-/1,200  
31 14 991 040      SCL-05

**10×**

product: non screw clip = for conductor cross-section: 0.2–4 mm<sup>2</sup> = current: 32 A = rated voltage: 450 V~ = packaging: 10 pcs, small box = dimensions: 30.3 × 20.1 × 9.2 mm = UV protection: no = working temperature range: -10°C – 85°C = complies with: EN 60998-2-1:2004; EN 60998-1:2004 = self-extinguishing: EN 60695-2-11 (850°C) = insulation voltage: EN 60998-2-1 (250 V)

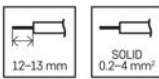

**A9111**      10/-/-/2,400  
31 14 991 110      ISCL-01

**10×**

product: non screw clip = for conductor cross-section: 0.2–4 mm<sup>2</sup> = current: 32 A = rated voltage: 450 V~ = packaging: 10 pcs, small box = dimensions: 39.3 × 10 × 8.3 mm = UV protection: no = working temperature range: -10°C – 85°C = complies with: EN 60998-2-1:2004; EN 60998-1:2004 = self-extinguishing: EN 60695-2-11 (850°C) = insulation voltage: EN 60998-2-1 (250 V)



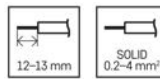

**A9112**      10/-/-/1,600  
31 14 991 120      ISCL-02

**10×**

product: non screw clip = for conductor cross-section: 0.2–4 mm<sup>2</sup> = current: 32 A = rated voltage: 450 V~ = packaging: 10 pcs, small box = dimensions: 39.3 × 10 × 14.9 mm = UV protection: no = working temperature range: -10°C – 85°C = complies with: EN 60998-2-1:2004; EN 60998-1:2004 = self-extinguishing: EN 60695-2-11 (850°C) = insulation voltage: EN 60998-2-1 (250 V)





**A9113** 10/-/-/600  
31 14 991 130 ISCL-03

**10×**

product: non screw clip = for conductor cross-section: 0.2–4 mm<sup>2</sup> = current: 32 A = rated voltage: 450 V~ = packaging: 10 pcs, small box = dimensions: 39.3 × 10 × 22.9 mm = UV protection: no = working temperature range: -10°C – 85°C = complies with: EN 60998-2-1:2004; EN 60998-1:2004 = self-extinguishing: EN 60695-2-11 (850°C) = insulation voltage: EN 60998-2-1 (250 V)





**A9121** 10/-/-/2,400  
31 14 991 210 PISC-03

**10×**

product: non screw clip = for conductor cross-section: 0.5–2.5 mm<sup>2</sup> = current: 24 A = rated voltage: 450 V~ = packaging: 10 pcs, small box = dimensions: 15.3 × 7.85 × 18.8 mm = UV protection: no = working temperature range: -10°C – 85°C = complies with: EN 60998-2-1:2004; EN 60998-1:2004 = self-extinguishing: EN 60695-2-11 (850°C) = insulation voltage: EN 60998-2-1 (250 V)





**A4101** 1/-/-/250  
31 46 001 040 TS12-04

**12 ×**

product: terminal block = for conductor cross-section: 2.5–4 mm<sup>2</sup> = current: 32 A = rated voltage: 400 V~ = hole diameter: 3.1 mm = packaging: 1 pc, packet = dimensions: 91.6 × 15.6 × 12 mm = UV protection: no = working temperature range: -30°C – 85°C = complies with: EN 60998-2-1:2004; EN 60998-1:2004 = self-extinguishing: EN 60695-2-11 (850°C) = insulation voltage: EN 60998-2-1 (250 V)





**A4102** 1/-/-/200  
31 46 001 060 TS12-06

**12 ×**

product: terminal block = for conductor cross-section: 4–6 mm<sup>2</sup> = current: 41 A = rated voltage: 400 V~ = hole diameter: 3.6 mm = packaging: 1 pc, packet = dimensions: 110.9 × 15.8 × 14.2 mm = UV protection: no = working temperature range: -30°C – 85°C = complies with: EN 60998-2-1:2004; EN 60998-1:2004 = self-extinguishing: EN 60695-2-11 (850°C) = insulation voltage: EN 60998-2-1 (250 V)





**A4103** 1/-/-/150  
31 46 001 100 TS12-10

**12 ×**

product: terminal block = for conductor cross-section: 6–10 mm<sup>2</sup> = current: 57 A = rated voltage: 400 V~ = hole diameter: 4.5 mm = packaging: 1 pc, packet = dimensions: 118 × 20.2 × 16.5 mm = UV protection: no = working temperature range: -30°C – 85°C = complies with: EN 60998-2-1:2004; EN 60998-1:2004 = self-extinguishing: EN 60695-2-11 (850°C) = insulation voltage: EN 60998-2-1 (250 V)





**A4105** 10/-/-/600  
31 46 011 040 TS12-04

**120 ×**

product: terminal block = for conductor cross-section: 1–4 mm<sup>2</sup> = current: 32 A = rated voltage: 400 V~ = hole diameter: 3.1 mm = packaging: 10 pcs, foil = dimensions: 91.6 × 15.6 × 12 mm = UV protection: no = working temperature range: -30°C – 85°C = complies with: EN 60998-2-1:2004; EN 60998-1:2004 = self-extinguishing: EN 60695-2-11 (850°C) = insulation voltage: EN 60998-2-1 (250 V)





**A4106** 10/-/-/400  
31 46 011 060 TS12-06

**120 ×**

product: terminal block = for conductor cross-section: 4–6 mm<sup>2</sup> = current: 41 A = rated voltage: 400 V~ = hole diameter: 3.6 mm = packaging: 10 pcs, foil = dimensions: 110.9 × 15.8 × 14.2 mm = UV protection: no = working temperature range: -30°C – 85°C = complies with: EN 60998-2-1:2004; EN 60998-1:2004 = self-extinguishing: EN 60695-2-11 (850°C) = insulation voltage: EN 60998-2-1 (250 V)

**A4107** 10/-/-/250  
31 46 011 100 TS12-10









**120 ×**

product: terminal block = for conductor cross-section: 6–10 mm<sup>2</sup> = current: 57 A = rated voltage: 400 V~ = hole diameter: 4.5 mm = packaging: 10 pcs, foil = dimensions: 118 × 20.2 × 16.5 mm = UV protection: no = working temperature range: -30°C – 85°C = complies with: EN 60998-2-1:2004; EN 60998-1:2004 = self-extinguishing: EN 60695-2-11 (850°C) = insulation voltage: EN 60998-2-1 (250 V)

## Fixing of cables, clips





**A2821**      50/-/-/7,500  
31 15 282 100      CCS-06B

**50x**

product: cable cleat = cable diameter: 6 mm = dimensions: 9 × 12 × 6 mm = packaging: 50 pcs, packet = colour: black = material: PE = working temperature range: -40°C – 85°C = mounting type: nail





**A2822**      50/-/-/7,500  
31 15 282 200      CCS-06W

**50x**

product: cable cleat = cable diameter: 6 mm = dimensions: 9 × 12 × 6 mm = packaging: 50 pcs, packet = colour: white = material: PE = working temperature range: -40°C – 85°C = mounting type: nail





**A2823**      50/-/-/5,000  
31 15 282 300      CCS-08B

**50x**

product: cable cleat = cable diameter: 8 mm = dimensions: 13 × 15 × 7 mm = packaging: 50 pcs, packet = colour: black = material: PE = working temperature range: -40°C – 85°C = mounting type: nail





**A2824**      50/-/-/5,000  
31 15 282 400      CCS-08W

**50x**

product: cable cleat = cable diameter: 8 mm = dimensions: 13 × 15 × 7 mm = packaging: 25 pieces, bag = colour: white = material: PE = working temperature range: -40°C – 85°C = mounting type: nail





**A2825**      50/-/-/5,000  
31 15 282 500      CCS-10B

**50x**

product: cable cleat = cable diameter: 10 mm = dimensions: 14 × 17 × 7 mm = packaging: 50 pcs, packet = colour: black = material: PE = working temperature range: -40°C – 85°C = mounting type: nail

**A2826**      50/-/-/5,000  
31 15 282 600      CCS-10W

**50x**

product: cable cleat = cable diameter: 10 mm = dimensions: 14 × 17 × 7 mm = packaging: 50 pcs, packet = colour: white = material: PE = working temperature range: -40°C – 85°C = mounting type: nail

**A2831**      25/-/-/5,000  
31 15 283 100      ATM-20B









**25x**

product: self-adhesive mounting base = dimensions: 20 × 20 mm = packaging: 25 pieces, bag = colour: black = material: ABS = working temperature range: -40°C – 80°C = mounting type: adhesive tape

**A2832**      25/-/-/5,000  
31 15 283 200      ATM-20W

**25x**

product: self-adhesive mounting base = dimensions: 20 × 20 mm = packaging: 25 pieces, bag = colour: white = material: ABS = working temperature range: -40°C – 80°C = mounting type: adhesive tape

**A2833** 25/-/-/2,500  
31 15 283 300 ATM-30B









25×

product: self-adhesive mounting base = dimensions: 30 × 30 mm = packaging: 25 pieces, bag = colour: black = material: ABS = working temperature range: -40°C – 80°C = mounting type: adhesive tape





**A2834** 25/-/-/2,500  
31 15 283 400 ATM-30W

25×

product: self-adhesive mounting base = dimensions: 30 × 30 mm = packaging: 25 pieces, bag = colour: white = material: ABS = working temperature range: -40°C – 80°C = mounting type: adhesive tape





**A2841** 100/-/-/25,000  
31 45 310 410 CT-10025B

100×

product: cable ties = dimensions: 2,5 × 100 mm = colour: black = UV protection: yes = tensile strength: 8 kg = maximum diameter: 22 mm = material: PA66 NYLON = working temperature range: -40°C – 85°C = self-extinguishing: EN IEC 60695-2-11 800°C; UL94 V-2





**A2842** 100/-/-/25,000  
31 45 310 420 CT-10025W

100×

product: cable ties = dimensions: 2,5 × 100 mm = colour: white = UV protection: no = tensile strength: 8 kg = maximum diameter: 22 mm = material: PA66 NYLON = working temperature range: -40°C – 85°C = self-extinguishing: EN IEC 60695-2-11 800°C; UL94 V-2





**A2843** 100/-/-/12,000  
31 45 310 430 CT-15035B

100×

product: cable ties = dimensions: 3,5 × 150 mm = colour: black = UV protection: yes = tensile strength: 18 kg = maximum diameter: 35 mm = material: PA66 NYLON = working temperature range: -40°C – 85°C = self-extinguishing: EN IEC 60695-2-11 800°C; UL94 V-2





**A2844** 100/-/-/12,000  
31 45 310 440 CT-15035W

100×

product: cable ties = dimensions: 3,5 × 150 mm = colour: white = UV protection: no = tensile strength: 18 kg = maximum diameter: 35 mm = material: PA66 NYLON = working temperature range: -40°C – 85°C = self-extinguishing: EN IEC 60695-2-11 800°C; UL94 V-2





**A2845** 100/-/-/10,000  
31 45 310 450 CT-20035B

100×

product: cable ties = dimensions: 3,5 × 200 mm = colour: black = UV protection: yes = tensile strength: 18 kg = maximum diameter: 53 mm = material: PA66 NYLON = working temperature range: -40°C – 85°C = self-extinguishing: EN IEC 60695-2-11 800°C; UL94 V-2





**A2846** 100/-/-/10,000  
31 45 310 460 CT-20035W

100×

product: cable ties = dimensions: 3,5 × 200 mm = colour: white = UV protection: no = tensile strength: 18 kg = maximum diameter: 53 mm = material: PA66 NYLON = working temperature range: -40°C – 85°C = self-extinguishing: EN IEC 60695-2-11 800°C; UL94 V-2





**A2847** 100/-/-/6,000  
31 45 310 470 CT-30035B

100×

product: cable ties = dimensions: 3,5 × 300 mm = colour: black = UV protection: yes = tensile strength: 18 kg = maximum diameter: 80 mm = material: PA66 NYLON = working temperature range: -40°C – 85°C = self-extinguishing: EN IEC 60695-2-11 800°C; UL94 V-2



**A2848** 100/-/-/6,000  
31 45 310 480 CT-30035W

100×

product: cable ties = dimensions: 3,5 × 300 mm = colour: white = UV protection: no = tensile strength: 18 kg = maximum diameter: 80 mm = material: PA66 NYLON = working temperature range: -40°C – 85°C = self-extinguishing: EN IEC 60695-2-11 800°C; UL94 V-2



**A2849** 100/-/-/6,000  
31 45 310 490 CT-25048B

**100×**

product: cable ties = dimensions: 4,8 × 200 mm = colour: black = UV protection: no = tensile strength: 22 kg = maximum diameter: 53 mm = material: PA66 NYLON = working temperature range: -40°C – 85°C = self-extinguishing: EN IEC 60695-2-11 800°C; UL94 V-2



**A2850** 100/-/-/6,000  
31 45 310 500 CT-20048W

**100×**

product: cable ties = dimensions: 4,8 × 200 mm = colour: white = UV protection: no = tensile strength: 22 kg = maximum diameter: 53 mm = material: PA66 NYLON = working temperature range: -40°C – 85°C = self-extinguishing: EN IEC 60695-2-11 800°C; UL94 V-2



**A2851** 100/-/-/5,000  
31 45 310 510 CT-25048B

**100×**

product: cable ties = dimensions: 4,8 × 250 mm = colour: black = UV protection: yes = tensile strength: 22 kg = maximum diameter: 65 mm = material: PA66 NYLON = working temperature range: -40°C – 85°C = self-extinguishing: EN IEC 60695-2-11 800°C; UL94 V-2



**A2852** 100/-/-/5,000  
31 45 310 520 CT-25048W

**100×**

product: cable ties = dimensions: 4,8 × 250 mm = colour: white = UV protection: no = tensile strength: 22 kg = maximum diameter: 65 mm = material: PA66 NYLON = working temperature range: -40°C – 85°C = self-extinguishing: EN IEC 60695-2-11 800°C; UL94 V-2



**A2853** 100/-/-/4,000  
31 45 310 530 CT-30048B

**100×**

product: cable ties = dimensions: 4,8 × 300 mm = colour: black = UV protection: yes = tensile strength: 22 kg = maximum diameter: 82 mm = material: PA66 NYLON = working temperature range: -40°C – 85°C = self-extinguishing: EN IEC 60695-2-11 800°C; UL94 V-2



**A2854** 100/-/-/4,000  
31 45 310 540 CT-30048W

**100×**

product: cable ties = dimensions: 4,8 × 300 mm = colour: white = UV protection: no = tensile strength: 22 kg = maximum diameter: 82 mm = material: PA66 NYLON = working temperature range: -40°C – 85°C = self-extinguishing: EN IEC 60695-2-11 800°C; UL94 V-2



**A2855** 100/-/-/4,000  
31 45 310 550 CT-35048B

**100×**

product: cable ties = dimensions: 4,8 × 350 mm = colour: black = UV protection: yes = tensile strength: 22 kg = maximum diameter: 90 mm = material: PA66 NYLON = working temperature range: -40°C – 85°C = self-extinguishing: EN IEC 60695-2-11 800°C; UL94 V-2



**A2856** 100/-/-/4,000  
31 45 310 560 CT-35048W

**100×**

product: cable ties = dimensions: 4,8 × 350 mm = colour: white = UV protection: no = tensile strength: 22 kg = maximum diameter: 90 mm = material: PA66 NYLON = working temperature range: -40°C – 85°C = self-extinguishing: EN IEC 60695-2-11 800°C; UL94 V-2



**A2857** 25/-/-/1,500  
31 45 310 570 CT-45076B

**25×**

product: cable ties = dimensions: 7,6 × 450 mm = colour: black = UV protection: yes = tensile strength: 55 kg = maximum diameter: 125 mm = material: PA66 NYLON = working temperature range: -40°C – 85°C = self-extinguishing: EN IEC 60695-2-11 800°C; UL94 V-2

**A2858** 25/-/-/1,500  
31 45 310 580 CT-45076W

**25×**

product: cable ties = dimensions: 7,6 × 450 mm = colour: white = UV protection: no = tensile strength: 55 kg = maximum diameter: 125 mm = material: PA66 NYLON = working temperature range: -40°C – 85°C = self-extinguishing: EN IEC 60695-2-11 800°C; UL94 V-2

# Tapes

## Other tapes

- repair tapes: durability and utility
- self-amalgamating tapes: material rubber or silicone
- universal DUCT TAPE: strong, high adhesion, water-tightness
- reflective tapes: increase biker, pedestrian and pram safety
- double-sided acrylic tapes: high adhesion and flexibility

tape type: insect stop repair tape = width: 50 mm = length: 2 m = thickness: 1.00 mm = recommended storage temperature: 5-40 °C = installation temperature range: 5-40 °C = ROHS compliant = UV resistant = adhesive material: hot melt = intended use: hobby, home interior = integrated textile mesh: 70 fibers = dimensions: 105 × 48 mm = packaging: 1 pc, paper box



**F6210** 1/-/-/60  
20 05 062 010 WSRT-01

tape type: double side NANOGRID tape = width: 19 mm = length: 3 m = thickness: 2 mm = recommended storage temperature: 5-40 °C = installation temperature range: 5-40 °C = ROHS compliant = UV resistant = adhesive material: acrylic = intended use: hobby, home interior = integrated textile mesh: 35 fibers = dimensions: 80 × 20 mm = packaging: 1 pc, paper box



**F6301** 1/-/-/60  
20 05 063 010 DSNT-01

tape type: double side DUCT tape = width: 50 mm = length: 10 m = thickness: 1.00 mm = recommended storage temperature: 5-40 °C = installation temperature range: 5-40 °C = ROHS compliant = UV resistant = adhesive material: hot melt = intended use: hobby, home interior = integrated textile mesh: 70 fibers = dimensions: 110 × 50 mm = packaging: 1 pc, paper box

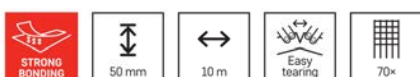

**F6302** 1/-/-/30  
20 05 063 020 DSDT-01

Order Code	Item Number	page	Order Code	Item Number	page	Order Code	Item Number	page	Order Code	Item Number	page	Order Code	Item Number	page
A1396.3	19 50 010 207	100	D3FW03	15 50 030 037	63	M0320N	22 02 029 000	91	Z7903	15 38 900 030	54	ZS3343.2	15 31 251 061	40
A1396.4	19 50 010 208	100	D3FW04	15 50 030 038	63	M0391N	22 02 030 000	92	Z7904	15 38 900 040	54	ZS3353	15 31 251 041	40
A2821	31 15 282 100	106	D730423	19 50 730 423	103	M0400N	22 02 028 000	91	Z7905	15 38 900 050	55			
A2822	31 15 282 200	106	DCCV25	15 50 000 196	66	M0420N	22 02 031 000	92	ZB2110	15 44 102 220	44			
A2823	31 15 282 300	106	DCGC02	15 50 002 048	65	M0430N	22 02 023 000	90	ZB2120	15 44 102 221	44			
A2824	31 15 282 400	106	DCGC03	15 50 002 049	65	M0501N	22 06 000 050	95	ZB2410	15 44 103 645	45			
A2825	31 15 282 500	106	DCGW17	15 50 000 193	65	M0503N	22 06 000 040	95	ZB4110	15 44 202 220	44			
A2826	31 15 282 600	106	DCGW18	15 50 000 194	65	M2092N	22 02 032 000	92	ZB4120	15 44 202 221	45			
A2831	31 15 283 100	106	DCGW19	15 50 000 195	67	M3216N	22 02 024 000	90	ZEO304	15 28 020 000	33			
A2832	31 15 283 200	106	DCPC10	15 50 005 022	64	M3620N	22 02 025 000	91	ZEO305	15 28 021 000	34			
A2833	31 15 283 300	107	DCWW44	15 50 000 197	66	M3691N	22 02 026 000	91	ZEO306	15 28 022 000	34			
A2834	31 15 283 400	107	E00032	26 03 209 000	71	N3110N	17 03 060 022	18	ZEO505A	15 28 001 402	33			
A2841	31 45 310 410	107	E0114N	26 03 124 000	70	N3111N	17 03 100 022	19	ZL8F52	15 25 730 236	32			
A2842	31 45 310 420	107	E0558	26 03 206 000	70	N3112N	17 03 150 022	19	ZL8F53	15 25 730 433	33			
A2843	31 45 310 430	107	E0558P	26 03 207 000	71	N3113N	17 03 225 022	19	ZL8F54	15 25 730 117	32			
A2844	31 45 310 440	107	E0558W	26 03 208 000	70	P0055E	19 10 001 000	82	ZM3406M	15 39 085 900	49			
A2845	31 45 310 450	107	E06000	26 93 000 250	71	P0055U	19 10 001 100	82	ZM3408M	15 39 085 130	49			
A2846	31 45 310 460	107	E6000	26 06 188 000	68	P0056U	19 10 001 200	83	ZM3409	15 39 085 190	49			
A2847	31 45 310 470	107	E6001	26 06 187 000	68	P0078	19 05 120 050	82	ZM5111	15 39 087 303	48			
A2848	31 45 310 480	107	E8625	26 06 186 000	69	P01110	19 01 811 005	75	ZM5112	15 39 087 452	48			
A2849	31 45 310 490	108	E8647N	26 06 184 000	69	P01210R	19 21 811 005	77	ZM5113	15 39 087 453	48			
A2850	31 45 310 500	108	E8647W	26 06 185 000	69	P3216	14 50 000 560	20	ZM5114	15 39 095 300	46			
A2851	31 45 310 510	108	F6210	20 05 062 010	109	P3325	14 60 000 000	23	ZM5115	15 39 095 450	46			
A2852	31 45 310 520	108	F6301	20 05 063 010	109	P3326	14 56 000 210	24	ZM5116	15 39 096 300	46			
A2853	31 45 310 530	108	F6302	20 05 065 020	109	P3327	14 40 043 100	23	ZM5117	15 39 096 450	47			
A2854	31 45 310 540	108	GS11111	14 54 008 200	56	P3543	14 41 351 500	21	ZM5118	15 39 097 300	47			
A2855	31 45 310 550	108	GS11151	14 54 015 200	56	P3544	14 41 361 900	21	ZM5119	15 39 097 450	47			
A2856	31 45 310 560	108	GS11A51	14 54 000 400	56	P3545	14 41 371 900	21	ZM5160	15 39 098 300	47			
A2857	31 45 310 570	108	GS11B51	14 54 000 500	57	P3546	14 41 381 900	21	ZM5161	15 39 098 450	47			
A2858	31 45 310 580	108	GS12111	14 54 016 100	57	P4010	14 40 041 500	20	ZQ3E01	15 25 731 438	28			
A4101	31 46 001 040	105	GS13142	14 54 000 100	56	P4546	14 50 000 580	22	ZQ3E03	15 25 731 459	28			
A4102	31 46 001 060	105	GS14151	14 54 000 600	57	P4722	14 40 033 104	24	ZQ5D76	15 25 733 502	29			
A4103	31 46 001 100	105	GS14251	14 54 000 700	57	P4723	14 39 013 903	25	ZQ5D77	15 25 733 128	28			
A4105	31 46 011 040	105	GS15114	15 45 000 900	58	P4724	14 50 000 570	25	ZQ5D78	15 25 733 501	29			
A4106	31 46 011 060	105	GS15117	14 54 000 800	57	P54013	19 09 030 150	78	ZQ5D79	15 25 733 502	29			
A4107	31 46 011 100	105	GS21111	14 54 017 100	59	P54014	19 09 030 151	78	ZQ5D86	15 25 730 435	28			
A9101	31 14 991 010	104	GS22111	14 54 013 200	58	P54015	19 09 060 151	78	ZQ5D87	15 25 733 503	29			
A9102	31 14 991 020	104	GS31111	14 54 000 200	58	P54016	19 09 060 301	79	ZQ5D88	15 25 730 120	27			
A9103	31 14 991 030	104	GS32111	14 54 000 300	58	P54017	19 09 060 500	79	ZQ5E24	15 25 730 118	26			
A9104	31 14 991 040	104	GS41151	14 54 000 110	59	P54018	19 09 060 152	79	ZQ5E29	15 25 730 239	27			
A9111	31 14 991 110	104	H2020	30 10 002 020	87	P54019	19 09 060 302	79	ZQ5E34N	15 25 730 121	27			
A9112	31 14 991 120	104	H2060	30 10 002 060	86	P54213	19 09 030 152	81	ZQ5E38	15 25 730 237	27			
A9113	31 14 991 130	105	H4062	30 24 040 620	87	P54214	19 09 030 153	81	ZQ5E42	15 25 730 434	28			
A9121	31 14 991 210	105	H4067	30 24 040 670	87	P54215	19 09 060 153	81	ZQ5E44	15 25 730 119	26			
B13763UP	10 41 007 623	14	H4072	30 24 040 720	88	P54216	19 09 060 303	80	ZQ5E48	15 25 766 204	31			
B15012U	10 22 000 112	12	H4073	30 24 040 730	88	P54217	19 09 060 501	80	ZQ5E52	15 25 766 205	32			
B15163UP	10 42 201 623	13	H4074	30 24 040 740	88	P54218	19 09 060 154	80	ZQ5E54	15 25 766 206	32			
B15253UP	10 42 202 523	13	H4080	30 10 040 800	85	P54219	19 09 060 304	80	ZQ5E58	15 25 736 213	30			
B15323UP	10 42 203 223	13	H4081	30 10 040 810	85	P5608	21 01 111 000	98	ZQ5E62	15 25 736 413	30			
B15325UP	10 42 203 225	14	H4082	30 10 040 820	86	P5618	21 01 112 000	98	ZQ5E66	15 25 736 101	29			
B35106	10 44 001 026	15	H4083	30 10 040 830	86	P5631S	21 01 900 017	97	ZQ5E68	15 25 766 201	31			
B35126	10 44 031 206	15	H4084	30 10 040 840	86	P56503X	21 04 107 000	99	ZQ5E72	15 25 766 202	31			
B35136	10 44 001 306	15	H5002	30 69 050 020	84	P56A01	21 01 211 000	97	ZQ5E74	15 25 766 203	31			
B35756	10 44 067 506	16	H5024	30 69 052 040	55	P56A02	21 01 214 000	98	ZQ5E78	15 25 736 214	30			
B50434	16 04 842 301	17	H5025	30 69 052 050	55	P56A11	21 01 311 000	97	ZQ5E82	15 25 736 215	30			
B54530	16 04 845 300	17	H5030	30 69 050 300	89	P56A01	21 01 213 000	96	ZQ5E84	15 25 736 414	30			
C3101.2	31 32 310 120	36	H5121	30 69 051 210	101	P56S01	21 01 212 000	97	ZQ5E86	15 25 736 415	31			
DOAC01	15 50 062 000	60	H5125	30 69 051 250	101	P56S01F	21 01 212 000	96	ZQ5E88	15 25 736 102	29			
DOAC02	15 50 062 001	60	H5126	30 69 051 260	101	P56S11	21 01 310 000	96	ZQ5E92.2	15 25 736 103	29			
DOAC03	15 50 062 002	60	H5127	30 69 051 270	101	PC0111	19 01 210 150	75	ZQ5E94	15 25 736 104	29			
DOAC04	15 50 062 007	61	H5128	30 69 051 280	102	PC0113R	19 01 210 301	75	ZQ5E96.2	15 25 736 105	29			
DOAN01	15 50 063 002	61	H5129	30 69 051 290	102	PC0115R	19 01 210 500	75	ZS2160	15 39 300 621	50			
DOAW01	15 50 060 000	60	H5131	30 69 051 310	102	PC0121R	19 01 210 150	77	ZS2161	15 39 301 021	50			
DOAW02	15 50 060 001	60	H5132	30 69 051 320	102	PC0123R	19 01 210 300	77	ZS2163	15 39 301 022	51			
DOAW03	15 50 060 002	60	H8106	30 81 000 010	89	PC0125R	19 01 210 501	77	ZS2164	15 39 301 023	51			
DOCC01	15 50 062 003	61	KE4916	32 33 049 160	74	PC01301	19 02 210 150	76	ZS2166	15 39 301 024	51			
DOCC02	15 50 062 004	61	KE6821	32 33 068 300	74	PC01303	19 02 210 300	76	ZS2167	15 39 301 025	51			
DOCC03	15 50 062 005	61	KTO1C	32 32 301 000	73	PC01305	19 02 210 500	76	ZS2514	15 31 291 000	37			
DOCC04	15 50 062 006	61	KTO1F	32 32 101 000	72	S4001R	23 04 000 400	92	ZS2524	15 31 292 000	37			
DOCN01	15 50 063 000	62	KTO1T	32 32 201 000	73	S4003N	23 04 000 500	92	ZS2534	15 31 293 000	38			
DOCN02	15 50 063 001	62	KTO1T	32 32 201 000	73	V02C48	17 04 023 400	18	ZS2544	15 31 294 000	38			
DOCW01	15 50 060 003	61	KTO2C	32 32 302 000	73	VIT665	17 04 023 500	18	ZS2554	15 31 295 000	38			
DOCW02	15 50 060 004	61	KTO2F	32 32 102 000	72	Z73217	15 35 253 000	34	ZS2564	15 31 296 000	39			
DOCW03	15 50 060 005	61	KTO2T	32 32 202 000	73	Z73218	15 35 254 000	35	ZS2574	15 31 297 000	39			
DOCW04	15 50 060 006	61	KTO3C	32 32 303 000	74	Z73227	15 35 255 000	35	ZS2584	15 31 298 000	39			
DOZB01	15 50 065 000	62	KTO3F	32 32 103 000	72	Z73228	15 35 256 000	35	ZS2594	15 31 299 000	39			
DOZB02	15 50 065 001	62	KTO3T	32 32 203 000	73	Z73237	15 35 257 000	35	ZS259					



Item Number	Order Code	page	Item Number	Order Code	page	Item Number	Order Code	page	Item Number	Order Code	page	Item Number	Order Code	page
10 22 000 112	B15012U	12	15 31 291 010	ZS2914	37	15 50 062 007	DOAC04	61	26 03 207 000	E0558P	71	32 33 049 160	KE4916	74
10 41 007 623	B13763UP	14	15 31 292 000	ZS2524	37	15 50 063 000	DOCN01	62	26 03 208 000	E0558W	70	32 33 068 300	KE6821	74
10 42 201 623	B15163UP	13	15 31 292 020	ZS2924	38	15 50 063 001	DOCN02	62	26 03 209 000	E00032	71			
10 42 202 523	B15253UP	13	15 31 293 000	ZS2534	38	15 50 063 002	DOAN01	61	26 06 184 000	E8647N	69			
10 42 203 223	B15323UP	13	15 31 293 030	ZS2934	38	15 50 065 000	DOZB01	62	26 06 185 000	E8647W	69			
10 42 203 225	B15325UP	14	15 31 295 000	ZS2544	38	15 50 065 001	DOZB02	62	26 06 186 000	E8625	69			
10 44 001 026	B35106	15	15 31 295 050	ZS2944	38	15 50 065 002	DOZB03	62	26 06 187 000	E6001	68			
10 44 001 306	B35136	15	15 31 296 000	ZS2554	39	15 50 065 003	DOZW01	62	26 06 188 000	E6000	68			
10 44 031 206	B35126	15	15 35 253 000	Z73217	34	16 04 842 301	B50434	17	26 93 000 250	E06000	71			
10 44 067 506	B35756	16	15 35 254 000	Z73218	35	16 04 845 300	B534530	17	30 10 002 020	H2020	87			
14 39 013 903	P4723	25	15 35 255 000	Z73227	35	17 03 060 022	N3110N	18	30 10 002 060	H2060	86			
14 40 033 104	P4722	24	15 35 256 000	Z73228	35	17 03 100 022	N3111N	19	30 10 040 800	H4080	85			
14 40 041 500	P4010	20	15 35 257 000	Z73237	35	17 03 150 022	N3112N	19	30 10 040 810	H4081	85			
14 40 043 100	P3327	23	15 35 258 000	Z73238	35	17 03 225 022	N3113N	19	30 10 040 820	H4082	86			
14 41 351 500	P3543	21	15 38 201 000	Z7640W	52	17 04 023 400	V02C48	18	30 10 040 830	H4083	86			
14 41 361 900	P3544	21	15 38 201 100	Z7640P	52	17 04 023 500	V1T665	18	30 10 040 840	H4084	86			
14 41 371 900	P3545	21	15 38 201 200	Z7640GR	52	19 01 210 150	PC0111	75	30 24 040 620	H4062	87			
14 41 381 900	P3546	21	15 38 201 300	Z7641B	53	19 01 210 301	PC0113R	75	30 24 040 670	H4067	87			
14 50 000 560	P3216	20	15 38 201 400	Z7641W	53	19 01 210 500	PC0115R	75	30 24 040 720	H4072	88			
14 50 000 570	P4724	25	15 38 201 500	Z7642B	53	19 01 811 005	P01110	75	30 24 040 730	H4073	88			
14 50 000 580	P4546	22	15 38 201 600	Z7642GL	53	19 02 210 150	PC01301	76	30 24 040 740	H4074	88			
14 54 000 100	GS13142	56	15 38 900 010	Z7901	54	19 02 210 300	PC01303	76	30 69 050 020	H5002	84			
14 54 000 110	GS41151	59	15 38 900 020	Z7902	54	19 02 210 500	PC01305	76	30 69 050 300	H5030	89			
14 54 000 200	GS31111	58	15 38 900 030	Z7903	54	19 05 120 050	P0078	82	30 69 051 210	H5121	101			
14 54 000 300	GS32111	58	15 38 900 040	Z7904	54	19 09 030 150	P54013	78	30 69 051 250	H5125	101			
14 54 000 400	GS11A51	56	15 38 900 050	Z7905	55	19 09 030 151	P54014	78	30 69 051 260	H5126	101			
14 54 000 500	GS11B51	57	15 39 085 130	ZM3408M	49	19 09 030 152	P54213	81	30 69 051 270	H5127	101			
14 54 000 600	GS14151	57	15 39 085 190	ZM3409	49	19 09 030 153	P54214	81	30 69 051 280	H5128	102			
14 54 000 700	GS14251	57	15 39 085 900	ZM3406M	49	19 09 060 151	P54015	78	30 69 051 290	H5129	102			
14 54 000 800	GS15117	57	15 39 087 303	ZM5111	48	19 09 060 152	P54018	79	30 69 051 310	H5131	102			
14 54 008 200	GS11111	56	15 39 087 452	ZM5112	48	19 09 060 153	P54215	81	30 69 051 320	H5132	102			
14 54 013 200	GS22111	56	15 39 087 453	ZM5113	48	19 09 060 154	P54218	80	30 69 052 040	H5024	55			
14 54 015 200	GS11151	58	15 39 095 300	ZM5114	46	19 09 060 301	P54016	79	30 69 052 050	H5025	55			
14 54 016 100	GS12111	57	15 39 095 450	ZM5115	46	19 09 060 302	P54019	79	30 81 000 010	H8106	89			
14 54 017 100	GS21111	59	15 39 096 300	ZM5116	46	19 09 060 303	P54216	80	31 14 991 010	A9101	104			
14 56 000 210	P3326	24	15 39 096 450	ZM5117	47	19 09 060 304	P54219	80	31 14 991 020	A9102	104			
14 60 000 000	P3325	23	15 39 097 300	ZM5118	47	19 09 060 500	P54017	79	31 14 991 030	A9103	104			
15 25 730 117	ZL8F54	32	15 39 097 450	ZM5119	47	19 09 060 501	P54217	80	31 14 991 040	A9104	104			
15 25 730 118	Z08E24	26	15 39 098 300	ZM5160	47	19 10 001 000	P0055E	82	31 14 991 110	A9111	104			
15 25 730 119	Z08E4	26	15 39 098 450	ZM5161	47	19 10 001 100	P0055U	82	31 14 991 120	A9112	104			
15 25 730 120	Z08D64	27	15 39 300 621	ZS2160	50	19 10 001 200	P0056U	83	31 14 991 130	A9113	105			
15 25 730 121	Z08E34N	27	15 39 300 622	ZS2163	50	19 21 210 150	PC0121R	77	31 14 991 210	A9121	105			
15 25 730 236	ZL8F52	32	15 39 300 623	ZS2166	51	19 21 210 300	PC0123R	77	31 15 282 100	A2821	106			
15 25 730 237	Z08E2	27	15 39 301 021	ZS2161	50	19 21 210 501	PC0125R	77	31 15 282 200	A2822	106			
15 25 730 238	Z08D62	27	15 39 301 022	ZS2164	51	19 21 811 005	P01210R	77	31 15 282 300	A2823	106			
15 25 730 239	Z08E32N	27	15 39 301 023	ZS2167	51	19 50 010 207	A1396.3	100	31 15 282 400	A2824	106			
15 25 730 433	ZL8F53	33	15 42 032 000	ZS2813	41	19 50 010 208	A1396.4	100	31 15 282 500	A2825	106			
15 25 730 434	Z08E13	28	15 42 033 000	ZS2823	41	19 50 730 423	D730423	103	31 15 282 600	A2826	106			
15 25 730 435	Z08D63	28	15 42 035 000	ZS2833	41	20 05 062 010	F6210	109	31 15 283 100	A2831	106			
15 25 731 438	Z03E01	28	15 44 102 220	ZB2110	44	20 05 063 010	F6301	109	31 15 283 200	A2832	106			
15 25 731 459	Z03E03	28	15 44 102 221	ZB2120	44	20 05 063 020	F6302	109	31 15 283 300	A2833	107			
15 25 733 128	Z05D77	28	15 44 103 645	ZB2410	45	21 01 111 000	P5608	98	31 15 283 400	A2834	107			
15 25 733 501	Z05D76	29	15 44 202 220	ZB4110	44	21 01 112 000	P5618	98	31 32 310 120	C3101.2	36			
15 25 733 502	Z05D75	29	15 44 202 221	ZB4120	45	21 01 211 000	P56A01	97	31 45 310 410	A2841	107			
15 25 736 101	Z09D14	29	15 45 000 900	GS15114	58	21 01 212 000	P56S01F	97	31 45 310 420	A2842	107			
15 25 736 102	Z09E24	29	15 50 000 193	DCGW17	65	21 01 213 000	P56S01	96	31 45 310 430	A2843	107			
15 25 736 103	Z09E24.2	29	15 50 000 194	DCGW18	65	21 01 214 000	P56A02	98	31 45 310 440	A2844	107			
15 25 736 213	Z09D12	30	15 50 000 195	DCGW19	67	21 01 310 000	P56S11	96	31 45 310 450	A2845	107			
15 25 736 214	Z09E22	30	15 50 000 196	DCCV25	66	21 01 311 000	P56A11	97	31 45 310 460	A2846	107			
15 25 736 215	Z09E22.2	30	15 50 000 197	DCWW44	66	21 01 900 017	P56S13	97	31 45 310 470	A2847	107			
15 25 736 413	Z09D13	30	15 50 002 048	DCGC02	65	21 04 107 000	P56503X	99	31 45 310 480	A2848	107			
15 25 736 414	Z09E23	30	15 50 002 049	DCGC03	65	22 01 020 000	M0018N	93	31 45 310 490	A2849	108			
15 25 736 415	Z09E23.2	31	15 50 005 022	DCPC10	64	22 01 021 000	M0048N	93	31 45 310 500	A2850	108			
15 25 766 201	Z09D32	31	15 50 030 036	D3FW02	63	22 01 022 000	M0012AN	93	31 45 310 510	A2851	108			
15 25 766 202	Z09D33	31	15 50 030 037	D3FW03	63	22 01 023 000	M0014AN	93	31 45 310 520	A2852	108			
15 25 766 203	Z09D34	31	15 50 030 038	D3FW04	63	22 01 024 000	M0003BN	94	31 45 310 530	A2853	108			
15 25 766 204	Z09C42	31	15 50 032 011	D3FC02	63	22 01 025 000	M0071N	94	31 45 310 540	A2854	108			
15 25 766 205	Z09C43	32	15 50 032 012	D3FC03	63	22 01 026 000	M0049N	94	31 45 310 550	A2855	108			
15 25 766 206	Z09C44	32	15 50 032 013	D3FC04	63	22 02 022 000	M0230N	90	31 45 310 560	A2856	108			
15 28 001 402	ZEO505A	33	15 50 034 004	D3FM02	64	22 02 023 000	M0430N	90	31 45 310 570	A2857	108			
15 28 020 000	ZEO304	33	15 50 034 005	D3FM03	64	22 02 024 000	M3216N	90	31 45 310 580	A2858	108			
15 28 021 000	ZEO305	34	15 50 034 006	D3FM04	64	22 02 025 000	M3620N	91	31 46 001 040	A4101	105			
15 28 022 000	ZEO306	34	15 50 060 000	DOAW01	60	22 02 026 000	M3691N	91	31 46 001 060	A4102	105			
15 31 223 500	ZS3213	42	15 50 060 001	DOAW02	60	22 02 027 000	M0305N	91	31 46 001 100	A4103	105			
15 31 223 502	ZS3213.2	43	15 50 060 002	DOAW03	60	22 02 028 000	M0400N	91	31 46 011 040	A4105	105			
15 31 224 500	ZS3214	42	15 50 060 003	DOCW01	61	22 02 029 000	M0320N	91	31 46 011 060	A4106	105			
15 31 224 502	ZS3214.2	43	15 50 060 004	DOCW02	61	22 02 030 000	M0							





## Explanatory notes and useful links



### Children's safety plugs

This icon in the catalogue refers to the presence of children's safety plugs in outlets of extension cords or surge protections.



### E-shop for Business Partners

We have an e-shop for business partners at <https://en.b2b.emos.cz>.  
Take advantage of the benefits of online purchasing of our products anywhere you need.



### Manuals for Goods

<https://www.emos.eu/download>

Here you can find all manuals for goods we have available, even for items no longer on offer. Manuals can also be downloaded from the product details.



### Photometric data

<https://www.emos.eu/download>

Here you can find photometric data for processing lighting projects using software tools such as DIALUX or RELUX.



A/ B/ C/ D

### Packaging

A – retail packaging  
B – number of products in a group packaging  
C – number of products per inner carton  
D – number of products per export carton



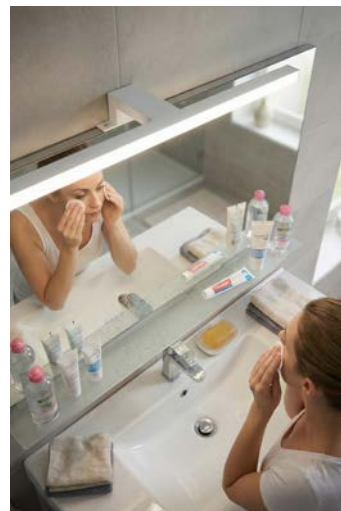
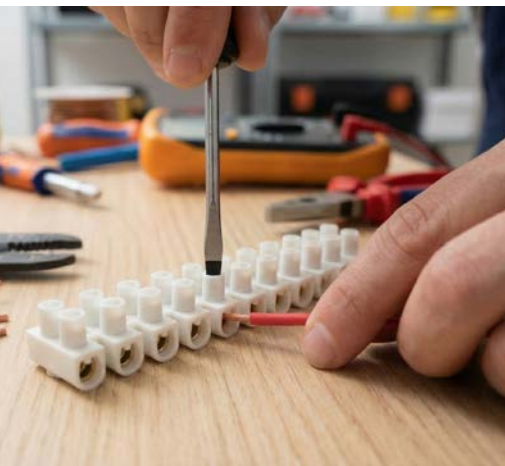

# Making Life Easy

EMOS spol. s r.o.  
Lipnicka 2844  
750 02 Prerov  
Czech Republic

e-mail: [emos@emos.cz](mailto:emos@emos.cz)  
phone: +420 581 261 111

[www.emos.eu/en](http://www.emos.eu/en)

Y11431



8 592920 160602

