



Lighting for the garden and house exterior

**EMOS**<sup>®</sup>

A brand of **legrand**<sup>®</sup>



Power for outdoor spaces



Lighting for atmosphere and entertainment



Portable lighting



Automation and security



Mounting and fixing solutions

# CATALOGUE SPRING | SUMMER



Making Life Easy



# Contents



## 02 Lighting for the garden and house exterior



-  1. Garden lighting 03
-  2. Solar lights 15
-  3. Orientation lights 23



## 25 Lighting for atmosphere and entertainment



-  1. String lights 26
-  2. Decorative lighting 30
-  3. Lamps 33



## 36 Portable lighting



-  1. Headlamps 37
-  2. Outdoor lighting 43
-  3. Work lights 47





## 52 Power for outdoor spaces



-  1. Reels 53
-  2. Cable connectors 57
-  4. Outdoor sockets 59



## 61 Automation and security



-  1. Sensors 62
-  2. Timers 65
-  3. Irrigation timers 68
-  4. Outdoor cameras 70
-  5. For pets 73

## 76 Mounting and fixing solutions



-  1. Cable accessories 77
-  2. Tapes 83



Our comprehensive range of outdoor lighting solutions covers functional, safety-related and decorative applications, and includes garden lights, solar floodlights and orientation lighting to enhance safety and visibility outdoors. The products combine modern technology with high-quality materials, ensuring reliable operation and a long life even in demanding conditions, and enabling effective lighting for pathways, entrances, façades and relaxation areas for a wide range of customers.



# Lighting for the garden and house exterior

1. Garden lighting
2. Solar floodlights
3. Orientation lighting

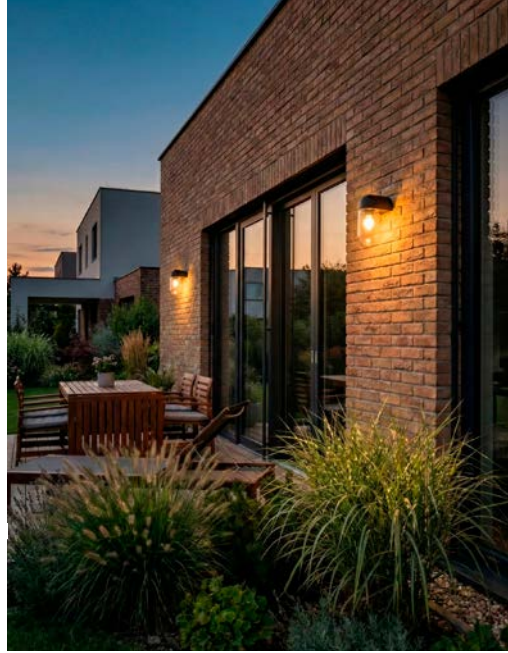

# Garden Lighting

We offer a comprehensive range of garden lighting, including wall-mounted and stake lights in various shapes and designs. The range enables you to put together an attractive and easily combinable selection for various types of outdoor spaces. The neutral colour schemes ensure versatility across a range of architectural styles. These products are suitable for both functional and decorative lighting in gardens, on patios and along access paths, and help promote seasonal sales in spring and summer.

# Garden lighting with a replaceable light source



Outdoor



E27



IP54



Metal  
body

## LANA line

- 2 wall lights and 2 post lights
- bulb with an E27 base (not included)
- sturdy aluminium body in anthracite colour
- diffuser made of durable plastic
- highly water-resistant and dustproof
- suitable for driveways, garages and house façades



ZGL010P



8 592920 143827



ZGL020P



8 592920 143841



ZGL0A0P



8 592920 143865



ZGL0C0P



8 592920 143889



Common number	Dimensions in mm	Body material	Diffuser material	Mounting
ZGL010P	119 × 106 × 218	aluminium	plastic	wall
ZGL020P	106 × 88 × 285	aluminium	plastic	wall
ZGL0A0P	154 × 133 × 450	aluminium	plastic	post
ZGL0C0P	154 × 133 × 750	aluminium	plastic	post

# SALVIA line

- 1 wall light and 1 pendant light
- bulb with an E27 base (not included)
- black steel body
- modern wired look
- plastic diffuser
- suitable for terraces, pergolas and house façades



Outdoor



E27



IP44



Metal body



ZGD010P



8 592920 143209



ZGD070P



8 592920 143223

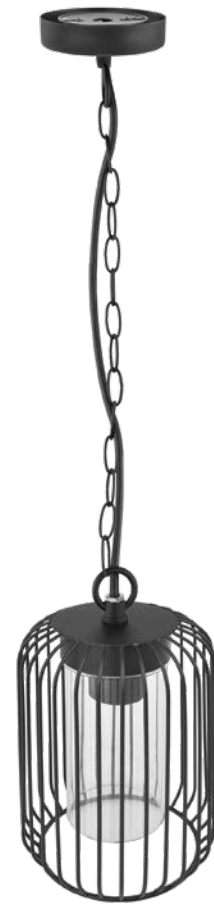

Common number	Dimensions in mm	Body material	Diffuser material	Mounting
ZGD010P	208 × 160 × 285	steel	plastic	wall
ZGD070P	160 × 160 × 760	steel	plastic	hanging

# ARTEO line

- 3 wall lights and 2 post lights
- 1 wall light with a PIR sensor
- bulb with an E27 base (not included)
- stainless steel body in anthracite colour
- elegant plastic diffuser
- suitable for gardens, terraces, driveways and building façades



Common number	Dimensions in mm	Body material	Diffuser material	Mounting	Twilight switch
ZGA010P	164 × 120 × 230	stainless steel	plastic	wall	-
ZGA020P	120 × 120 × 330	stainless steel	plastic	wall	-
ZGA040P	164 × 120 × 295	stainless steel	plastic	wall	yes
ZGA0A0P	120 × 120 × 500	stainless steel	plastic	post	-
ZGA0C0P	120 × 120 × 800	stainless steel	plastic	post	-

# ADENIA line

- 3 wall lights
- 1 wall light with a PIR sensor
- bulb with an E27 base (not included)
- modern aluminium body in black
- plastic diffuser in the shape of a lantern
- suitable for low walls, terraces and building façades



ZGB010P



ZGB020P



ZGB040P

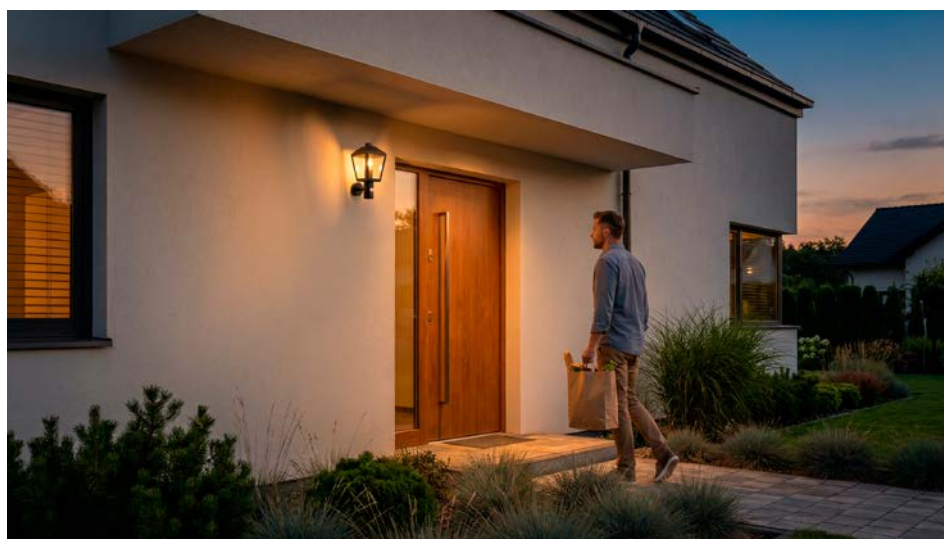
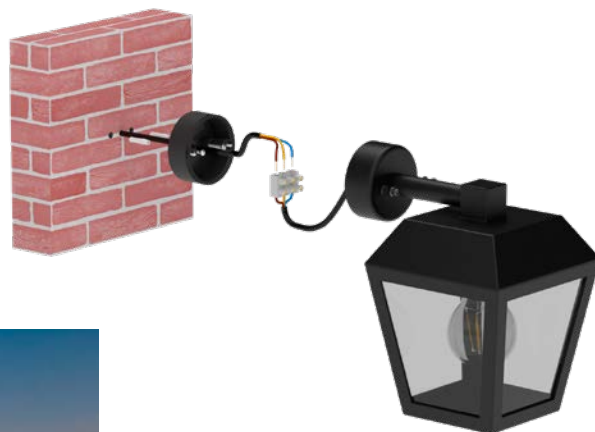

Common number	Dimensions in mm	Body material	Diffuser material	Mounting	Twilight switch
ZGB010P	198 × 150 × 278	aluminium	plastic	wall	-
ZGB020P	180 × 150 × 245	aluminium	plastic	wall	-
ZGB040P	198 × 150 × 298	aluminium	plastic	wall	yes

# ZALA line

- 2 wall lights and 1 post light
- 1 wall light with a PIR sensor
- bulb with an E27 base (not included)
- oval stainless steel body in anthracite colour
- plastic diffuser
- suitable for building façades, driveways, garden walkways



ZGC010P



ZGC040P



ZGC0A0P

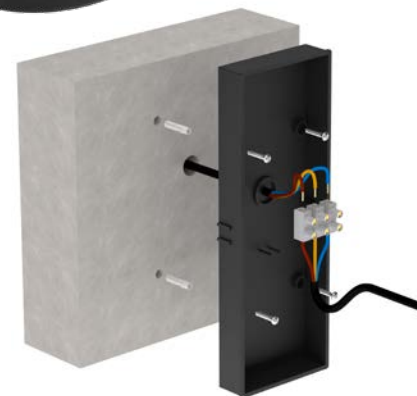

Common number	Dimensions in mm	Body material	Diffuser material	Mounting	Twilight switch
ZGC010P	128 × 80 × 230	stainless steel	plastic	wall	-
ZGC040P	128 × 80 × 270	stainless steel	plastic	wall	yes
ZGC0A0P	140 × 140 × 500	stainless steel	plastic	post	-

# MALVA line

- 2 wall lights
- 1 wall light with a built-in PIR sensor
- bulb with an E27 base (not included)
- aluminium body frame in black
- rectangular plastic diffuser
- suitable for the façades of modern buildings



Outdoor



E27



IP44



Metal body



ZGH010P



8 592920 143605



ZGH040P



8 592920 143629



PIR sensor

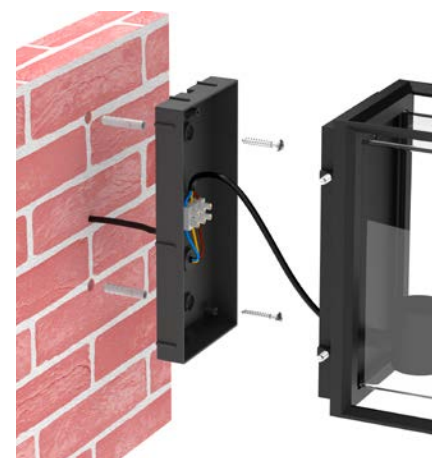

Common number	Dimensions in mm	Body material	Diffuser material	Mounting	Twilight switch
ZGH010P	130 × 120 × 250	aluminium	plastic	wall	-
ZGH040P	130 × 120 × 280	aluminium	plastic	wall	yes

# TILLIA line

- 1 wall light
- bulb with an E27 base (not included)
- aluminium body frame in black
- oval plastic diffuser
- suitable for the façades of modern buildings



Outdoor



E27



IP44



Metal body



ZGI010P

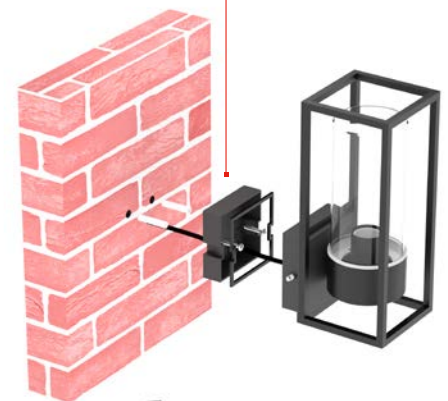
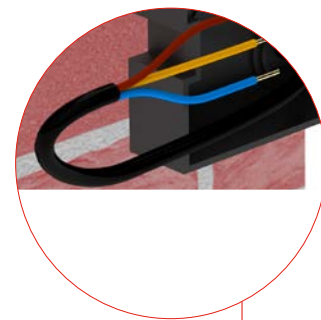

Common number	Dimensions in mm	Body material	Diffuser material	Mounting
ZGI010P	128 × 110 × 270	aluminium	plastic	wall

# CASSIA line

- 1 wall light
- bulb with an E27 base (not included)
- oval aluminium body in anthracite colour
- glass diffuser
- suitable for building façades

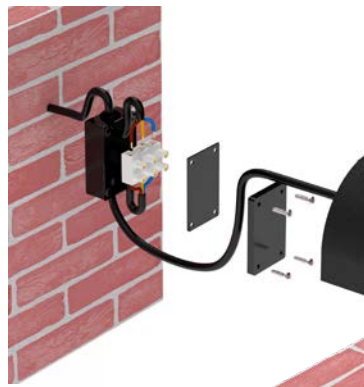

Common number	Dimensions in mm	Body material	Diffuser material	Mounting
ZGG010P	126 × 95 × 222	aluminium	glass	wall

# OCULUS line

- 2 wall lights
- 1 or 2 bulbs with a GU10 base (not included)
- sturdy plastic body in black
- modern, minimalist design for any house façade

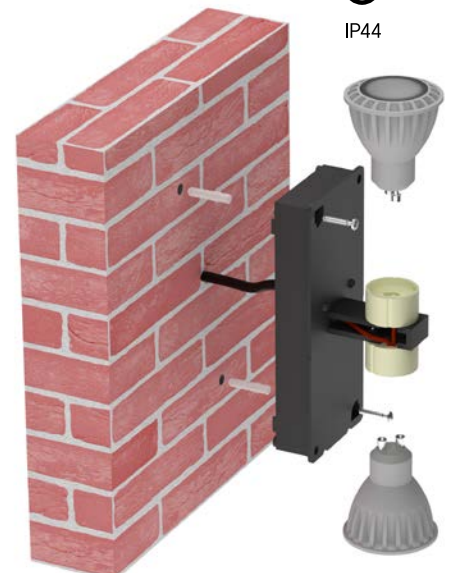
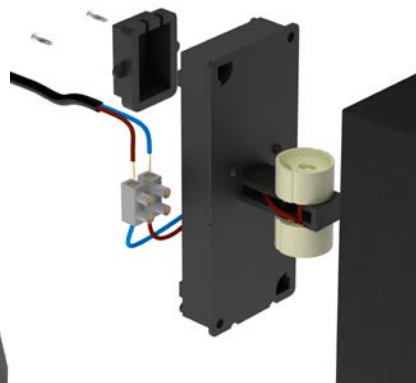

Common number	Dimensions in mm	Body material	Diffuser material	Mounting
ZGF010P	88 × 67 × 80	plastic	plastic	wall
ZGF020P	88 × 67 × 153	plastic	plastic	wall

# Garden lighting with integrated light source



12.5 W

3 000 K  
WARM WHITE

## NIKA line

- 2 wall lights and 2 post lights
- warm white LED light
- 1 wall light with a built-in PIR sensor
- post lights for screwing into the ground
- aluminium lamp body in anthracite colour
- square plastic diffuser
- joint for rotating the diffuser
- luminous flux 900 lm



ZGE014L



ZGE044L



ZGE0A4L



ZGE0C4L



Common number	Dimensions in mm	Body material	Diffuser material	Mounting	Twilight switch
ZGE014L	120 × 120 × 200	aluminium	plastic	wall	-
ZGE044L	120 × 120 × 200	aluminium	plastic	wall	yes
ZGE0A4L	120 × 120 × 500	aluminium	plastic	post	-
ZGE0C4L	120 × 120 × 800	aluminium	plastic	post	-

# Solar-powered garden lighting

## TERION line

- 1 wall light and 2 post lights
- entire line features an integrated PIR sensor
- solar power with no need for an external power supply
- integrated light with warm white colour
- sturdy oval metal body
- plastic oval diffuser
- can stay on all night if fully charged

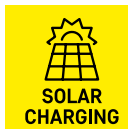

**3 000 K**  
WARM WHITE



Common number	Dimensions in mm	Powered by Li-Ion accumulator	Photovol. cell	Body material	Diffuser material	Mounting	Twilight switch
ZGJ044S	147 × 125 × 146	3.7 V / 1,200 mAh	0.88 W	stainless steel	plastic	wall	yes
ZGJ0B4S	125 × 125 × 500	3.7 V / 1,200 mAh	0.88 W	stainless steel	plastic	post	yes
ZGJ0F4S	125 × 125 × 805	3.7 V / 1,200 mAh	0.88 W	stainless steel	plastic	post	yes

# VEREA line

- 1 wall light and 1 post light
- entire line features an integrated PIR sensor
- integrated light with warm white colour
- post light for staking into the ground
- highly effective solar power with no need for an external power supply
- solid modern aluminium body in black
- can stay on all night



ZGK044S



8 592920 143711



ZGK0B4S



8 592920 143735



SOLAR CHARGING



Outdoor



460 lm



IP44



Metal body



PIR sensor

3

Lighting modes

3 000 K

WARM WHITE

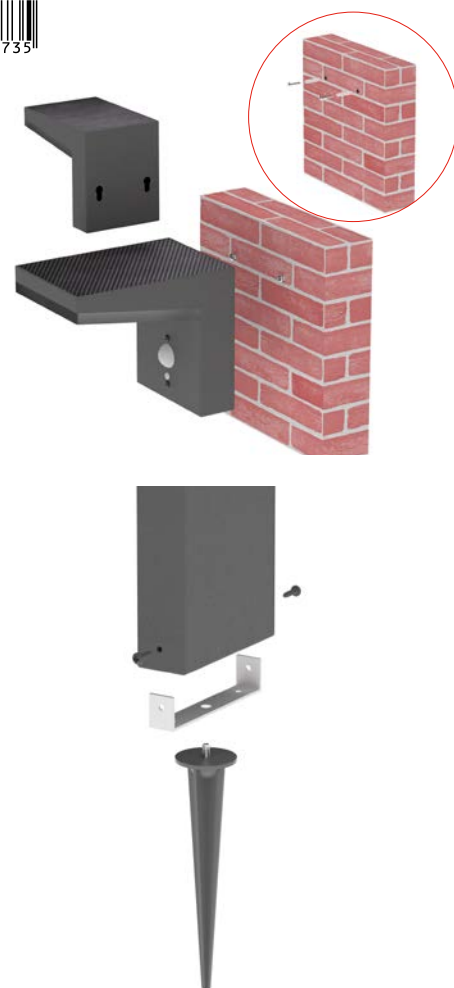

Common number	Dimensions in mm	Powered by Li-Ion accumulator	Photovol. cell	Body material	Diffuser material	Mounting	Twilight switch
ZGK044S	107 × 154 × 130	3.7 V / 2,200 mAh	2.1 W	aluminium	plastic	wall	yes
ZGK0B4S	107 × 154 × 500	3.7 V / 2,200 mAh	2.1 W	aluminium	plastic	post	yes



# Solar floodlights

Designed for reliable and energy-efficient outdoor lighting. Solar power eliminates the need for cabling and electrical connections, thereby simplifying installation and reducing operating costs. The modern design in neutral colours ensures usability across a wide range of exteriors. Built for long-term operation in difficult outdoor conditions.



# SUNNO line

- built-in PIR sensor for motion detection
- no power consumption
- 3 light modes
- IP54, providing reliable protection against dust and spraying water
- flexible placement – the floodlight can be placed in the shade, while the solar panel can be exposed to the sun thanks to a 1.8 m cable
- motion sensor with a range of up to 6 metres

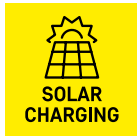

NEUTRAL WHITE

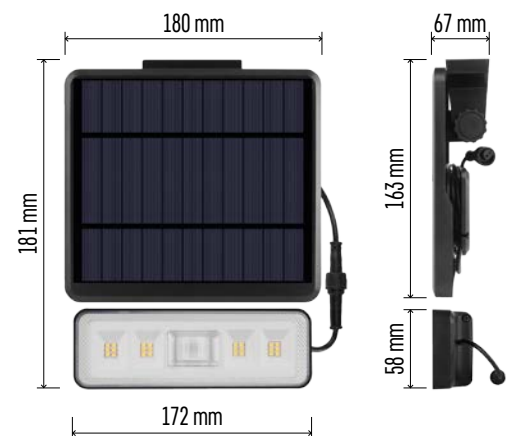

Common number	Dimensions in mm	Luminous flux	Body material	Diffuser material	CCT	Beam angle	Detection angle	Detection range
ZG112S	181 × 180 × 70	1,300 lm	plastic (ABS+PC)	plastic (PC)	4,000 K	100°	120°	6 m

# SOLO line

- built-in PIR sensor for motion detection
- no power consumption from the mains
- 3 light modes
- IP54, providing reliable protection against dust and spraying water
- easy installation
- for lighting driveways, gardens or small car parks

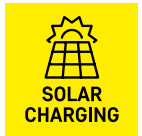

Outdoor



Replacable  
Type 18650



IP54



8-12 h



PIR sensor  
120°/4-6 m

**3**

Lighting  
modes

**3**

YEARS  
WARRANTY

NEUTRAL  
WHITE



ZG121S



ZG122S



Common number	Dimensions in mm	Luminous flux	Body material	Diffuser material	CCT	Beam angle	Detection angle	Detection range
ZG121S	145 × 136 × 26	1,000 lm	plastic (ABS+PC)	plastic (PC)	4,000 K	100°	120°	6 m
ZG122S	190 × 184 × 28	1,600 lm	plastic (ABS+PC)	plastic (PC)	4,000 K	100°	120°	6 m

# SPILO line

- remote control
- built-in PIR sensor for motion detection
- no power consumption from the mains
- can be surface-mounted or stuck into the ground using a stake
- ideal for lighting the house exterior, garden paths, shrubs and trees



ZG131S



8 592920 132586



Remote Control



ZG132S



8 592920 132609

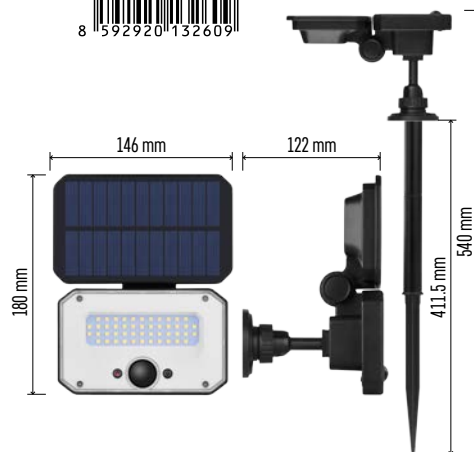

Outdoor



1 500 lm



IP54



8-12 h



PIR sensor  
120°/max 6 m

3

Lighting  
modes

**3**  
YEARS  
WARRANTY

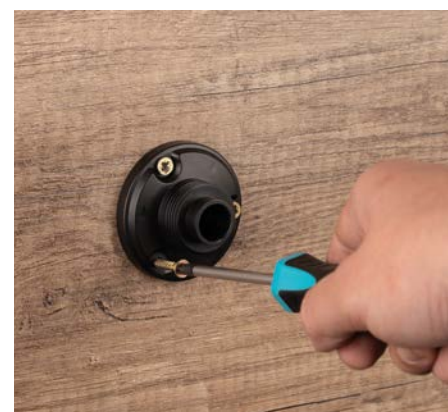

Common number	Dimensions in mm	Colour temperature	Luminous flux	Body material	Diffuser material	CCT	Beam angle	Detection angle	Detection range
ZG131S	180 × 146 × 122	warm white	1,500 lm	plastic (ABS+PC)	plastic (PC)	3,000 K	110°	120°	6 m
ZG132S	180 × 146 × 122	neutral white	1,500 lm	plastic (ABS+PC)	plastic (PC)	4,000 K	110°	120°	6 m

# LUNIS line

- built-in PIR sensor for motion detection
- IP65 rating for extreme resistance to water and dust
- no power consumption from the mains
- hook for hanging
- ideal for lighting staircases, the sides of walkways and driveways, or pergolas



ZG151S



8 592920 132623



Replacable Type 18650



220 lm



IP65



8-12 h



PIR sensor 120°/max 6 m

2

Lighting modes

NEUTRAL WHITE

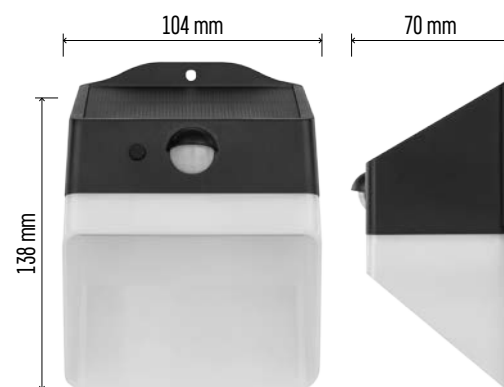

Common number	Dimensions in mm	Luminous flux	Body material	Diffuser material	CCT	Beam angle	Detection angle	Detection range
ZG151S	139 × 104 × 70	220 lm	plastic (ABS+PC)	plastic (PC)	4,000 K	120° × 60°	120°	6 m

# BRIXO line

- built-in PIR sensor for motion detection
- no power consumption from the mains
- 2 light modes
- IP65 enclosure guarantees water and dust resistance
- ideal for permanent lighting of outdoor spaces

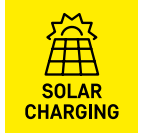

NEUTRAL WHITE



ZG161S



ZG162S



ZG165S



ZG166S



Common number	Dimensions in mm	Luminous flux	Body material	Diffuser material	CCT	Beam angle	Detection angle	Detection range
ZG161S	138 × 90 × 35	350 lm	plastic (ABS+PC)	plastic (PC)	4,000 K	140° × 70°	120°	6 m
ZG162S	138 × 90 × 35	350 lm	plastic (ABS+PC)	plastic (PC)	4,000 K	140° × 70°	120°	6 m
ZG165S	230 × 97 × 43	900 lm	plastic (ABS+PC)	plastic (PC)	4,000 K	140° × 70°	120°	7 m
ZG166S	230 × 97 × 43	900 lm	plastic (ABS+PC)	plastic (PC)	4,000 K	140° × 70°	120°	7 m

# LUMI line

- built-in PIR sensor for motion detection
- no power consumption from the mains
- 2 light modes
- IP54 enclosure ensures for water resistance
- ideal for permanent lighting of outdoor spaces

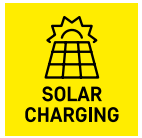

Outdoor



240 lm



IP54



12-15 h



PIR sensor  
120°/1-5 m

**2**

Lighting  
modes

**NEUTRAL  
WHITE**



ZG172S

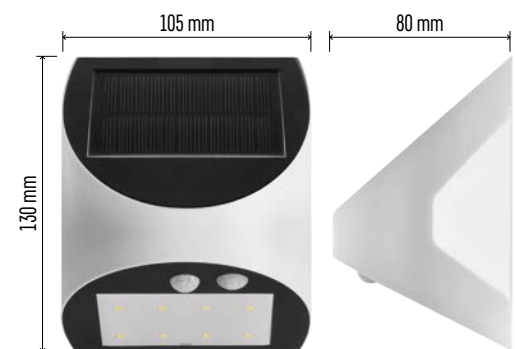

Common number	Dimensions in mm	Luminous flux	Body material	Diffuser material	CCT	Beam angle	Detection angle	Detection range
ZG172S	105 × 130 × 80	240 lm	plastic (ABS+PC)	plastic (PC)	4,000 K	120°	120°	5 m

# Rechargeable batteries for RAVER SOLAR lamps



- a reliable power supply for solar garden lights
- more than 500 charge cycles for a long life
- NiMH technology with no memory effect
- temperature resistance from  $-20\text{ }^{\circ}\text{C}$  to  $+50\text{ }^{\circ}\text{C}$  for outdoor use
- a handy pack of 2, ideal as spare batteries for solar lamps



B7414



B7426



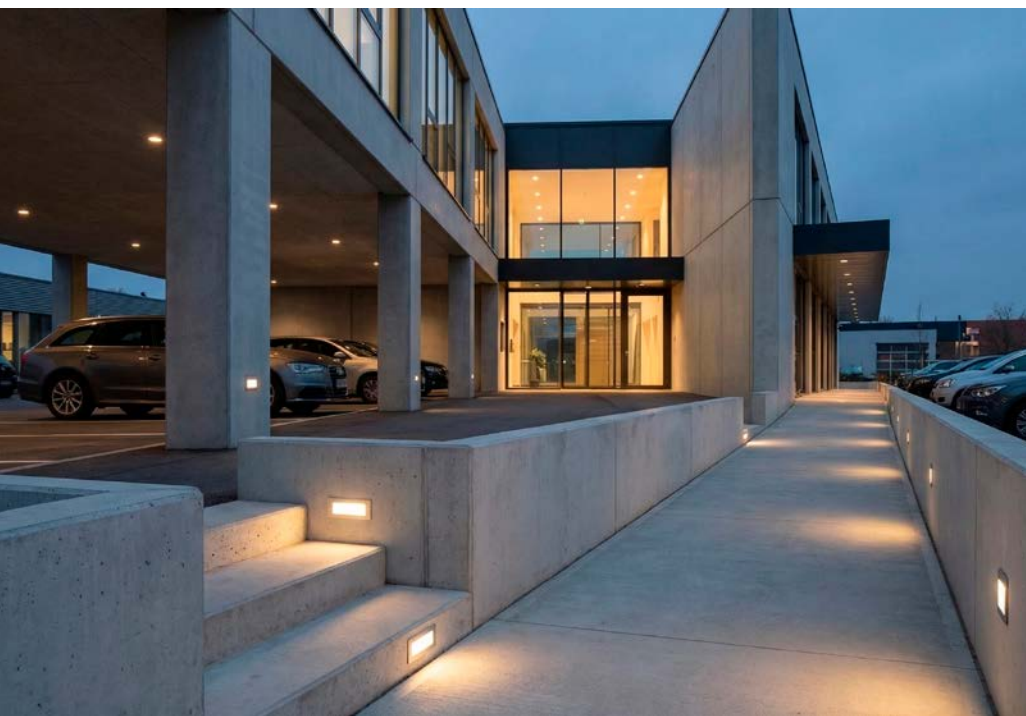

# Orientation lighting

# 3

This category includes solutions designed to enhance safety and visibility both indoors and outdoors. The range is designed to provide effective lighting for entrances, walkways, car parks and other highly frequented or strategic locations. They ensure reliable orientation in reduced visibility and help to enhance the building's safety standards. Suitable for both residential and commercial applications.

# AMAL line

- minimal power consumption
- IP65 enclosure ensures water resistance
- for flush mounting
- aluminium body with a glass diffuser
- exceptional durability thanks to high-quality materials
- neutral or warm white light
- for use in both households and industrial spaces, for lighting staircases, house façades, low walls etc.



1.5 W



30 000 h



Change



Dimmable



ZC0108



ZC0110

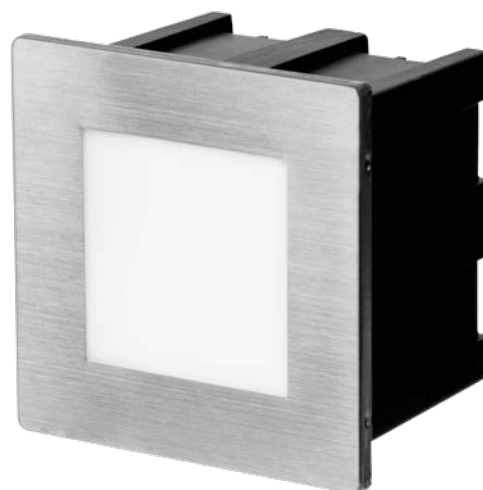

ZC0109



ZC0111

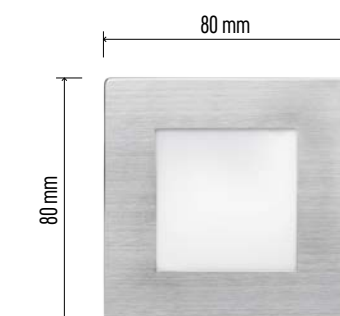

Common number	Dimensions in mm	Colour temperature	CCT	Luminous flux	Input power	Luminous efficacy
ZC0108	123 × 53 × 61	warm white	3,000 K	60 lm	1.5 W	40 lm/W
ZC0109	80 × 80 × 61	warm white	3,000 K	65 lm	2 W	33 lm/W
ZC0110	123 × 53 × 61	neutral white	4,000 K	65 lm	2 W	33 lm/W
ZC0111	80 × 80 × 61	neutral white	4,000 K	65 lm	2 W	33 lm/W

This category encompasses decorative and ambient lighting designed to enhance the appeal of both outdoor and indoor spaces during the spring and summer months. The range includes string lights, decorative lights and portable lamps suitable for gardens, patios, pergolas, balconies and for temporary installations.



# Lighting for atmosphere and entertainment

1. String lights
2. Decorative lighting
3. Lamps



# String lights

The range of string lights is designed for seasonal use outdoors. The range enables the creation of effective lighting installations in gardens, on terraces and pergolas, as well as in commercial spaces such as restaurants and event venues.



# LED solar decorative lighting

- low operating cost
- stylish design
- for outdoor and indoor use
- long life
- year-round use

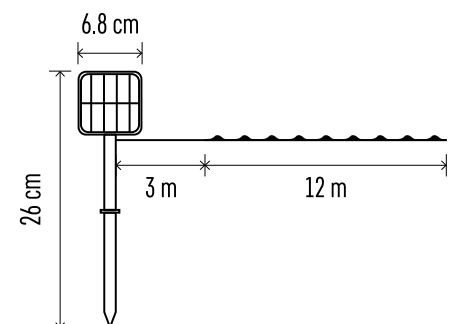
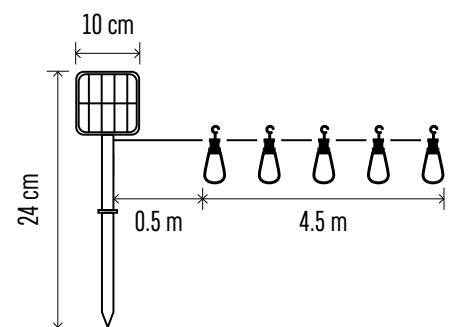
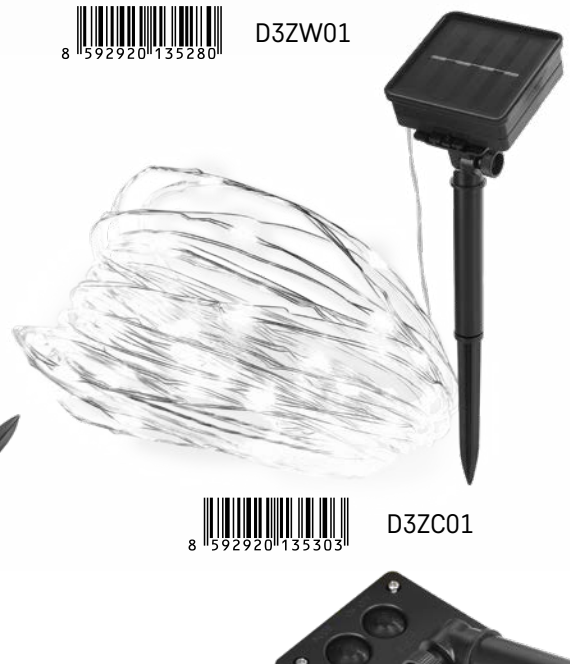
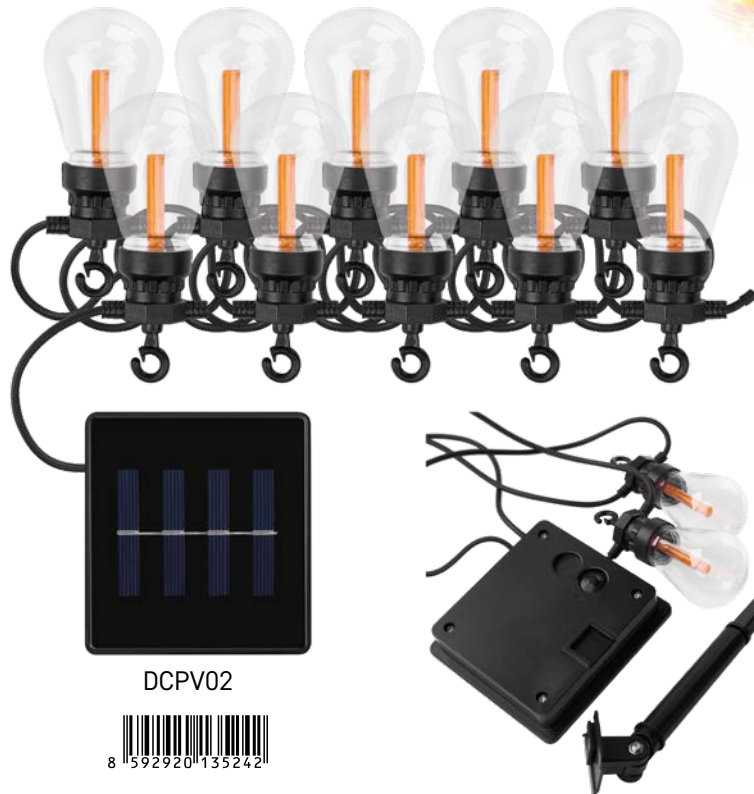
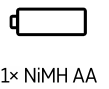
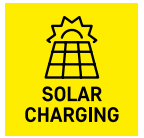

Common number	Colour temperature	Timer	Dimensions	Cable length	Cable colour	No. of LEDs	Material	Input power
D3ZW01	warm white	yes	12 m	3 m	copper	120	metal	2.4 W
D3ZC01	cool white	yes	12 m	3 m	silver	120	metal	2.4 W
DCPV02	warm white	-	4.5 m	0.5 m	black	10	plastic	0.6 W

# Party bulbs string lights

- designer party bulbs in a variety of colours and styles
- compact design and sufficiently long power cables for easy installation
- universal power supply (mains adapter)
- fitted with long-life LED light sources with low power consumption
- supply cable length for strings: 5 m



IN/OUT



IP44



10 000 h



DCPW01



DCPV01



DCPC08



DCPW07



Common number	Colour temperature	Length of the string section with lights	No. of LEDs	Input power	Output voltage
<b>DCPW01</b>	warm white	5 m	50	5 W	24 V DC
<b>DCPV01</b>	VINTAGE	4.5 m	100	5 W	5 V DC
<b>DCPC08</b>	cool white	4.5 m	10	5 W	5 V DC
<b>DCPW07</b>	warm white	7.6 m	20	7.5 W	30 V DC

# GoSmart LED string light

- colour-changing bulbs and string
- glows in time with the music
- 16 million RGB colours
- long life
- year-round use
- dimmable

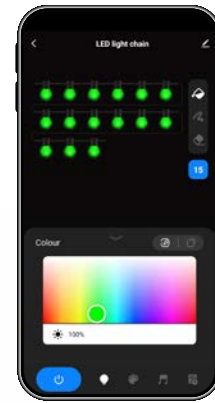

12 W



ZIW17FR



8 592920 136973

10 % 100 %

RGBIC

a handy hook for hanging



ON/OFF

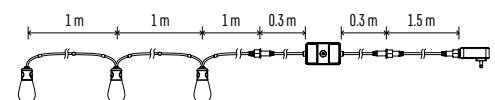

Common number	No. of segments	Colour temperature	Body colour	Material	Supply cable length
ZIW17FR	15	RGBIC	black	plastic	1.5 m



# Decorative lighting

The decorative lighting section includes products designed to enhance the visual appeal of both outdoor and indoor spaces. The range is built to enable the creation of striking lighting accents and to add an aesthetic element to functional lighting.

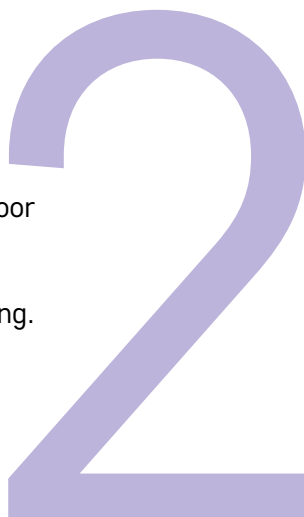

# GoSmart spotlight

- Outdoor spotlights for intense illumination of a specific spot, ideal for lighting gardens, driveways or dark nooks
- starter kit (4 pcs) and expansion kit (1 pc), maximum expansion to 8 pcs
- the spacing between the lights is 3 m
- programmable RGBIC+CCT; each spotlight can shine in a different colour depending on the settings in the app; dimmable
- mounted using a stake
- the power supply is included only in the starter kit (ZIWI194R)

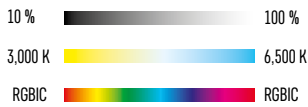

ZIWI191R

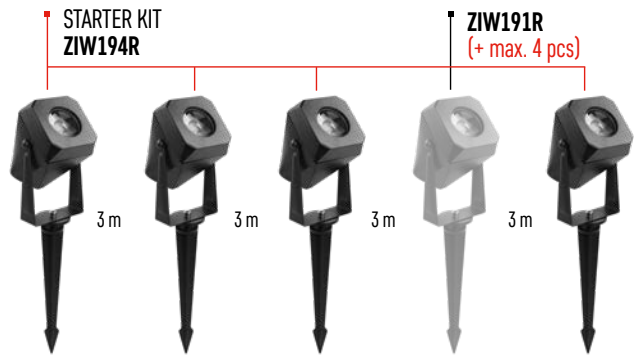

Common number	Colour temperature	Luminous flux	Body colour	No. of segments	Material	Input power
ZIWI194R	warm white-cool white	400 lm	black	4	plastic	7 W
ZIWI191R	warm white-cool white	100 lm	black	1	plastic	1.5 W

# GoSmart outdoor floodlight

- starter kit (3 pcs) and expansion kit (1 pc), maximum expansion to 6 floodlights
- outdoor floodlights for lighting the house exterior, gardens, pergolas, walls, etc.
- set and controlled via a mobile app
- programmable RGBIC+CCT; each floodlight can shine in a different colour depending on the settings in the app; dimmable
- frosted diffuser for a cosier atmosphere
- flexible mounting – using a wall bracket or a stake (included)
- the power supply is included only in the starter kit (ZIW184R)

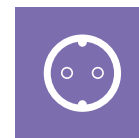

Outdoor



IP65



1.5 m cable

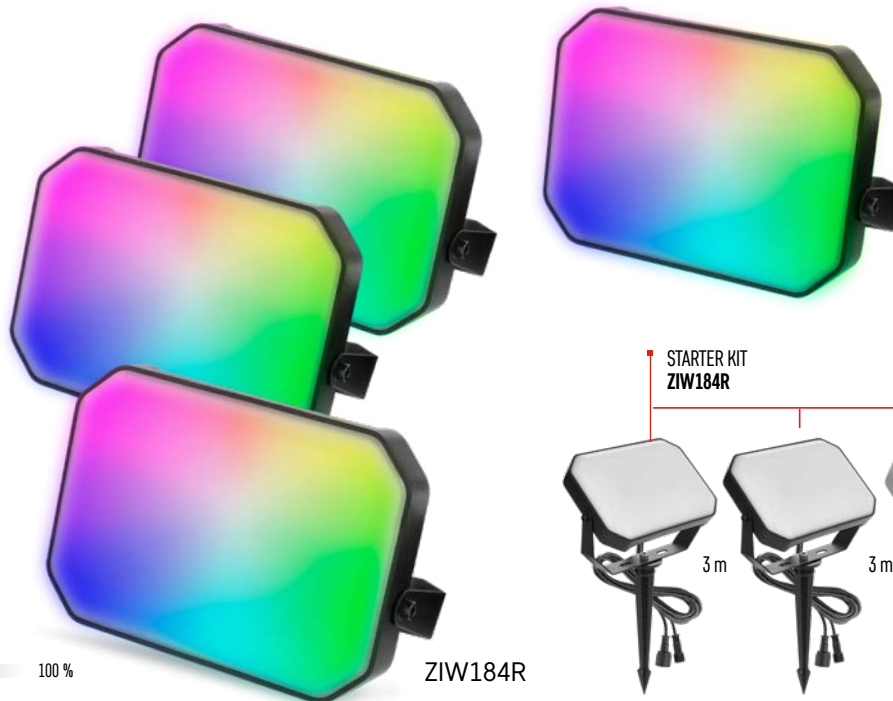

ZIW181R



8 592920 136959

STARTER KIT  
ZIW184R

ZIW181R  
(+ max. 3 pcs)



ZIW184R



8 592920 136935

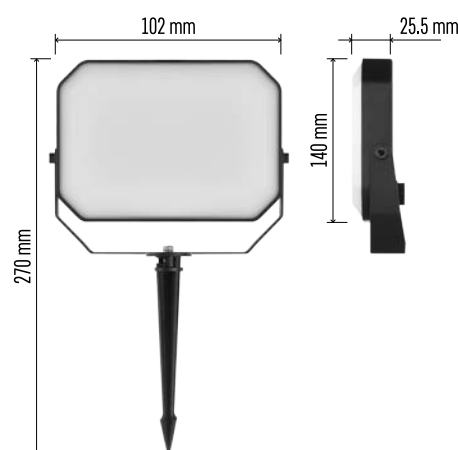

Common number	Colour temperature	Luminous flux	body colour	No. of segments	Material	Input power
ZIW181R	warm white-cool white	330 lm	black	1	plastic	4 W
ZIW184R	warm white-cool white	990 lm	black	3	plastic	14 W



# Lamps

Portable lamps offer a mobile solution for gardens, patios, balconies and leisure activities. These models are easy to use without the need for a power lead and are ideal for seasonal sales campaigns.

Grow lights add a functional solution to the portfolio, designed to support plant growth both indoors and outdoors. This range is a response to the rising interest in growing herbs, vegetables and ornamental plants at home, and allows us to expand our product range with items that can be sold all year round.

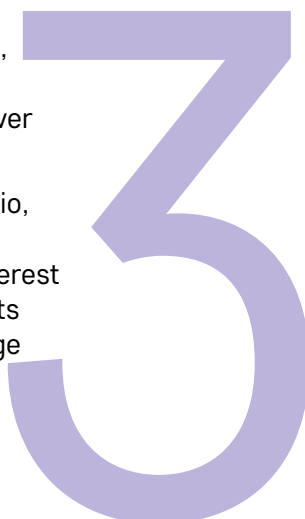

# Outdoor table lamps

- weather-resistant (IP44)
- low energy consumption and a long life
- convenient power supply or charging via a USB cable
- option to select the colour temperature on most models
- sturdy and durable body



**KATIE**  
Z7630W



**KATIE**  
Z7630B



Z7633  
**JASON**



Z7634  
**GRACE**

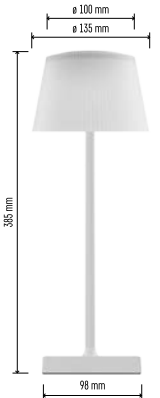

Common number	Dimensions in mm	Lamp colour	Colour temperature	Material	Luminous flux	Input power
<b>Z7630W</b>	330 × 130 × 150	white	warm/neutral/cool white	plastic	250 lm	4 W
<b>Z7630B</b>	330 × 130 × 150	black	warm/neutral/cool white	plastic	250 lm	4 W
<b>Z7633</b>	270 × 140	black	warm/neutral/cool white	ABS plastic	180 lm	2.2 W
<b>Z7634</b>	350 × 140	black	neutral white	plastic + metal	80 lm	4.2 W

# LED grow lights

- full-spectrum LED light to promote growth at all stages
- suitable for year-round indoor use (IP20)
- built-in timer for an automatic lighting cycle
- energy-efficient LED technology with a long life
- compact design and easy installation

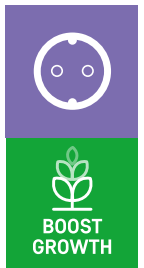

Indoor



Timer



Full spectrum LED



Z7901



**UNIVERSAL**

For promoting plant growth, the development of a strong root system and bountiful flowering.



Herbs



House plants

Vegetables



Succulents

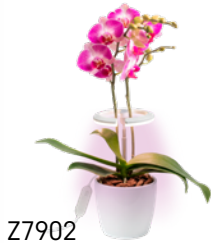

Z7902



**FLOWERS**

Gentle light for sensitive plants and beautiful flowers.



Herbs



House plants

Vegetables



Succulents



Z7903



**SEEDS**

For seed germination, seedling growth and strong young plants.



Seeds

Seedlings



Z7904



**HERBS**

For basil, mint, thyme... a stronger flavour and aroma.



Herbs



Vegetables

Succulents



Z7905



**DESIGN**

A stylish accessory to provide light for your plants.



Herbs



House plants

Succulents

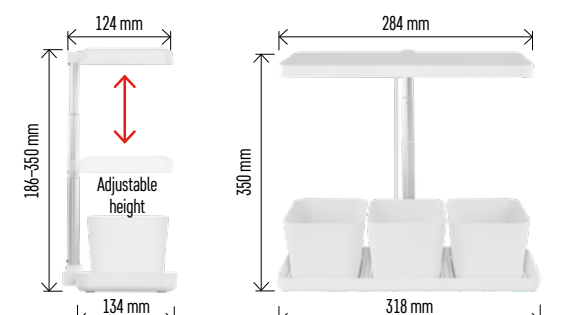
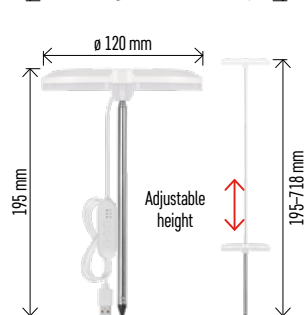
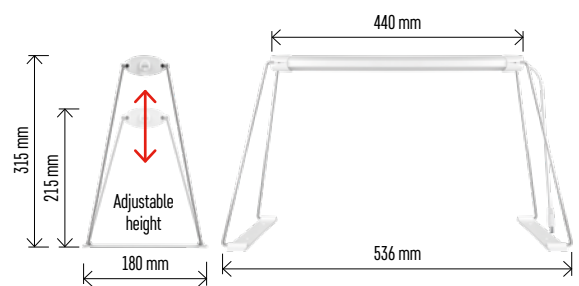
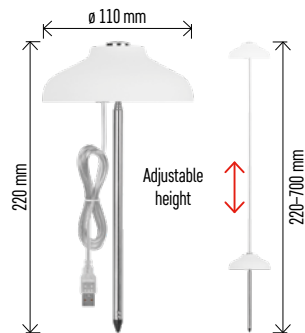

Common number	Dimensions in mm	Colour temperature	Luminous flux	No. of LEDs	Power supply	Input power	Dimmable
Z7901	110 × 110 × 220	daylight white/red	235 lm	15	USB-A	5 W	no
Z7902	120 × 120 × 195	daylight white/red	300 lm	39	USB-A	8 W	yes
Z7903	536 × 180 × 215	daylight white	800 lm	28	24 V DC/1,000 mA	15 W	no
Z7904	318 × 134 × 186	daylight white/red	300 lm	30	USB-A	7 W	yes
Z7905	210 × 210 × 517	daylight white	450 lm	21	24 V DC/1,000 mA	7 W	no



The portable lighting range includes headlamps, flashlights and work lights designed for mobile and temporary use both indoors and outdoors. The range is designed for a wide spectrum of applications – from hobby use to technical and professional deployment.

The products are characterised by their compact design, ease of use and a range of power supply options (battery-powered and rechargeable). The range makes it possible to put together a comprehensive selection covering everyday use, outdoor activities and the workplace.



# Portable lighting

1. Headlamps
2. Outdoor lighting
3. Work lights



OUTDOOR

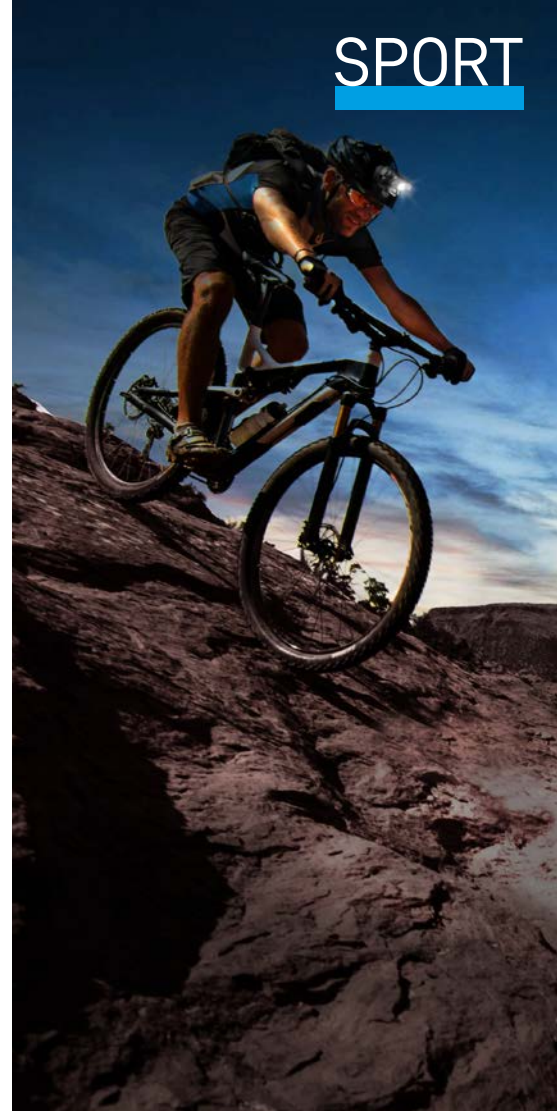

SPORT



MULTI

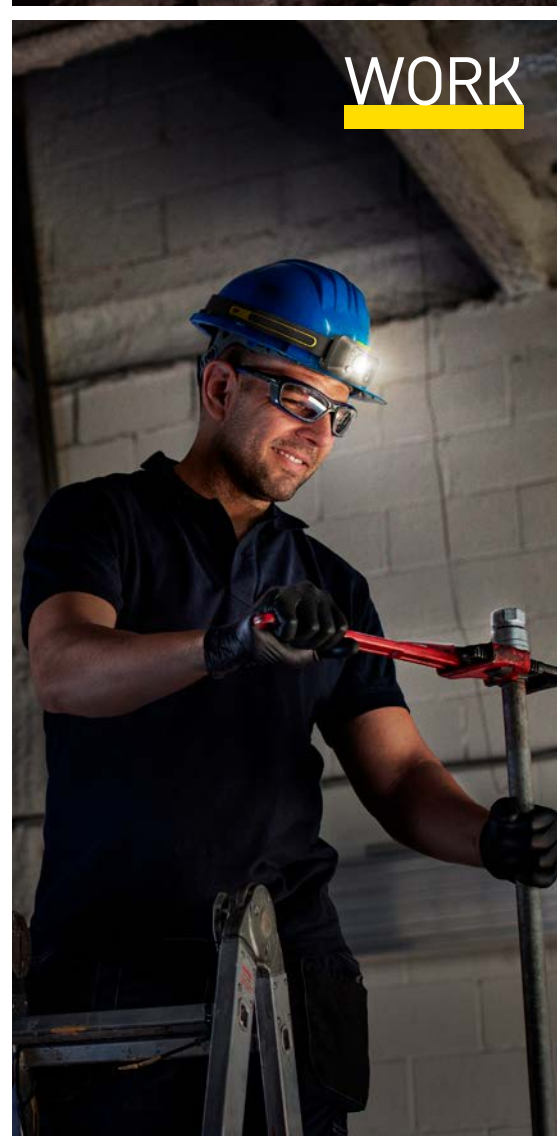

WORK

# Headlamps

The range of EMOS and GP headlamps offers practical and portable lighting solutions for work, leisure activities and technical applications. The products are designed with a focus on comfort, ease of use and reliable performance in a variety of conditions. The range includes models with varying light output, power sources (battery-powered and rechargeable) and features, which cater to the needs of both hobbyists and discerning customers.

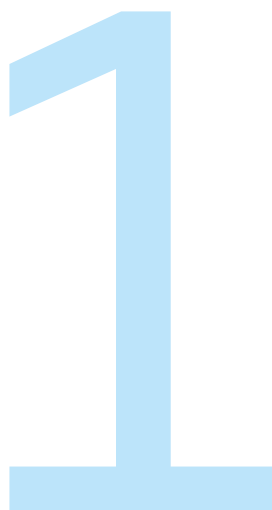

# Outdoor LED headlamps

**EMOS**  
A brand of **Legrand**

**OUTDOOR**

- a wide range of power, beam range and runtime capabilities
- multiple lighting modes
- both battery-powered and rechargeable versions
- suitable for outdoor use (IP rating, impact resistance)
- selected models include practical elements for safe and comfortable use (reflective strip, red light)



P3531



P3536



P3546



P3539



P3542

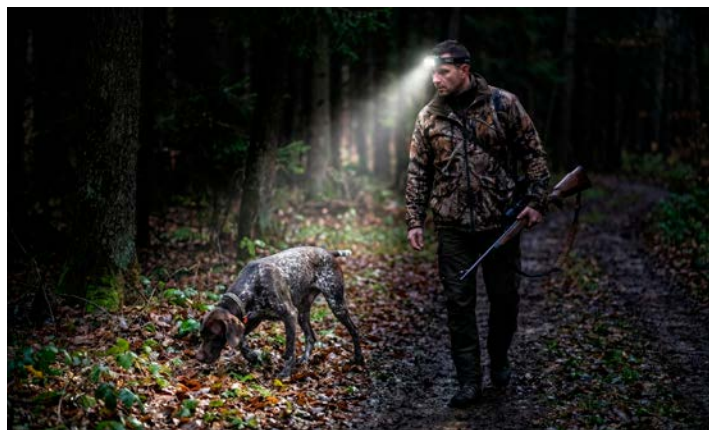

Common number	Light source	Maximum luminous flux	Maximum beam range	Number of lighting modes	Runtime	Charging	Power supply	Dimensions in mm	Weight
P3531	CREE LED + COB LED + red LED	330 lm	65 m	7	18-72 h	no	3x AAA + 1x CR2032	65 x 32 x 39	80 g/115 g
P3536	LED + COB LED	220 lm	100 m	7	45-160 h	no	3x AAA	65 x 45 x 50	65 g/100 g
P3542	COB LED + LED	500 lm	130 m	7	4-6.5 h	yes	Li-pol	70 x 45 x 35	90 g
P3539	CREE LED + 2x red LED	330 lm	200 m	5	50-87 h	no	3x AAA	60 x 48 x 43	70 g/105 g
P3546	7x LED	550 lm	110 m	7	3.5-9 h	yes	Li-pol / 3xAAA	64 x 48 x 32	77 g

# Outdoor LED headlamps



# OUTDOOR

- various levels of power, beam range and runtime
- several lighting modes, including supplementary functions (e.g. red light)
- available in both battery-powered and rechargeable versions
- suitable for outdoor use (IP rating, impact resistance)
- smart details for safe and comfortable use (reflective strip, quick switch-off/controls lock)



P8569



- 3 YEARS WARRANTY
- rechargeable
- spot-flood light
- light boost
- 11 lighting modes



P8555



- rechargeable
- 5 LIGHTING MODES
- LIGHT BY CREE LED Light
- waterproof
- impact resistant



P8582



- spot-flood light
- 4 LIGHTING MODES
- impact resistant
- FUNCTION RETURN PROTECTION



P8583



- spot-flood light
- red light
- 5 LIGHTING MODES
- waterproof
- impact resistant



P8584



- Touchless control
- spot-flood light
- red light
- 6 LIGHTING MODES
- waterproof



Common number	Light source	Maximum luminous flux	Maximum beam range	Number of lighting modes	Runtime	Charging	Power supply	Dimensions in mm	Weight
P8569	2× Osram SMD LED	1,200 lm	110 m	11	2–100 h	yes	Li-ion/2× CR123A	91.5 × 39 × 51	90 g/151 g
P8555	CREE SMD LED	600 lm	130 m	5	40 s – 60 h	yes	Li-ion	106 × 27 × 27	153 g
P8583	2× SMD LED + LED	150 lm	45 m	5	36 hours	no	3× AAA	61 × 47 × 37	42 g/78 g
P8584	2× SMD LED	300 lm	60 m	6	36 hours	no	3× AAA	61 × 47 × 37	42 g/78 g
P8582	2× SMD LED	110 lm	40 m	4	15 hours	no	3× AAA	59 × 46 × 34	29 g/65 g

# Sports LED headlamps

SPORT

- multiple lighting modes for the ability to adjust power and runtime
- lightweight and compact design for comfortable wear even during prolonged activity
- sturdy, impact-resistant body suitable for active use in the field
- reflective elements on the strap on selected models

**EMOS**  
A brand of **legrand**



P3521



- 3x AAA
- REFLEX
- 4 LIGHTING MODES
- red light

**EMOS**  
A brand of **legrand**



P3537



- 3x AAA
- 3 LIGHTING MODES

**3**  
YEARS WARRANTY



**10**  
LIGHTING MODES

**GP**



P8571



**3**  
YEARS WARRANTY



**4**  
LIGHTING MODES



LIGHT BY **CREE**  
LED LIGHT

**EMOS**  
A brand of **legrand**



P3534



- RECHARGEABLE
- REFLEX
- 4 LIGHTING MODES

**GP**



P8572



**3**  
YEARS WARRANTY



**4**  
LIGHTING MODES



Common number	Light source	Maximum luminous flux	Maximum beam range	Number of lighting modes	Runtime	Charging	Power supply	Dimensions in mm	Weight
P3521	LED + 2x red LEDs	85 lm	65 m	4	50-120 h	no	3x AAA	58 x 38 x 44	54 g/89 g
P3534	CREE LED	230 lm	80 m	4	3-13 h	yes	Li-pol	61 x 37 x 31	60 g
P3537	COB LED	110 lm	15 m	3	20-40 h	no	3x AAA	60 x 18 x 40	21 g/56 g
P8567	3x CREE SMD LED	500 lm	85 m	10	60 s - 100 h	yes	Li-pol	56 x 38 x 39	59.5 g
P8572	CREE SMD LED	300 lm	157 m	4	5-69 h	yes	3x AAA	34 x 46 x 56	110 g
P8571	CREE SMD LED	300 lm	157 m	4	5-69 h	no	3x AAA	34 x 46 x 56	110 g

# LED work headlamps

- multiple lighting modes for quick adjustment of brightness to suit the activity
- durable design with a impact-resistant construction, suitable for work environments
- both rechargeable and battery-powered versions (powered by standard AAA batteries)
- compact dimensions and low weight for comfortable wear over long periods
- reliable LED light for everyday use in the workshop, repair shop or around the house

**EMOS**  
A brand of **Legrand**



**GP**

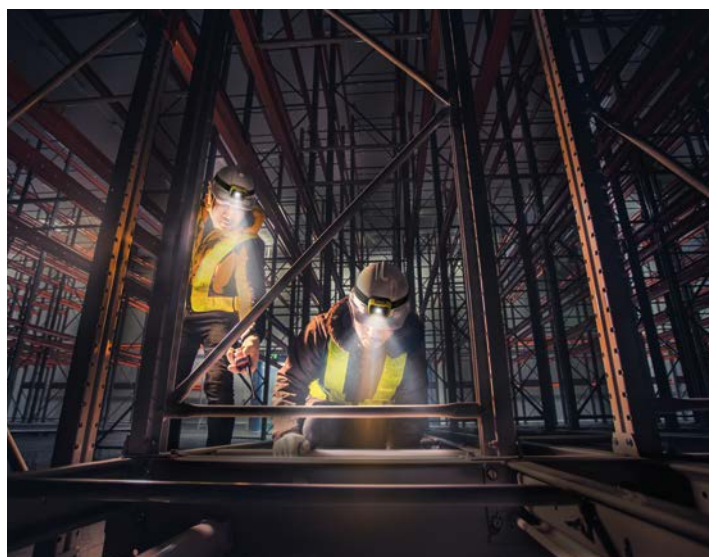

Common number	Light source	Maximum luminous flux	Maximum beam range	Number of lighting modes	Runtime	Power supply	Dimensions in mm	Weight
<b>P3541</b>	COB LED + LED	380 lm	30 m	4	3-12 h	Li-pol	300 × 3.2 × 20	73 g
<b>P8573</b>	2× CREE SMD LED	280 lm	90 m	6	25 hours	3× AAA	66 × 49 × 37	95 g
<b>P8574</b>	2× CREE SMD LED	375 lm	110 m	4	26 hours	3× AAA	66 × 49 × 37	62 g/98 g

# Multifunctional LED headlamps

MULTI

- compact and lightweight design, suitable for everyday use and outdoor activities
- rechargeable Li-ion / Li-pol accumulator, including a cable for convenient recharging
- multiple lighting modes to adapt performance to the current activity
- impact-resistant body
- battery protection for longer life and stable performance



RECHARGEABLE
 NO FIRE
 2 LIGHTING MODES
 IMPACT RESISTANCE
 REFLEX
 COOL WHITE
 **P3544**

 8 592920 153574

RECHARGEABLE
 red light
 NO FIRE
 5 LIGHTING MODES
 IMPACT RESISTANCE
 WATER RESISTANCE
 WARM WHITE
 COOL WHITE
 **P3545**

 8 592920 152515



Common number	Light source	Maximum luminous flux	Maximum beam range	Number of lighting modes	Runtime	Power supply	Dimensions in mm	Weight
<b>P3544</b>	LED	500 lm	120 m	2	1-4 h	Li-ion	80 × 29 × 30 mm	60 g
<b>P3545</b>	3× LED	175 lm	50 m	5	2-4.5 h	Li-pol	52 × 29 × 35 mm	56 g



# Outdoor lighting

For reliable use in camping, travel, outdoor activities and at the cottage. The range includes compact lanterns and flashlights for lighting tents and the campsite, safety lights and signalling elements for improved visibility in low-light conditions, as well as practical solutions that enhance comfort during outdoor activities.



# Practical display boxes with outdoor lighting

## COB LED lantern

- batteries included in the packaging for immediate use
- evenly distributed COB light for practical illumination
- a hook for easy hanging and greater versatility
- a compact lantern for promotional and seasonal sales
- lantern dimensions 108 × 128 mm



## COB LED fob lantern

- Compact fob design with a clip, magnet and swivel stand
- charging via modern USB-C with fast charging
- durable impact-resistant body
- high light output for powerful lighting



# Practical display boxes with outdoor lighting

## LED bracelet

- safety product
- long runtime of up to 160 hours
- visibility to up to 400 m
- ideal for children, sport and leisure
- bracelet dimensions 190 × 35 × 17 mm

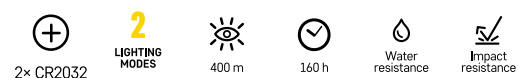

P4713



## USB-powered LED bulb

- rechargeable via modern USB-C
- compact size and a hook for easy hanging
- bulb size 170 × 55 × 55 mm



P4719



# LED warning triangle

- a bright LED warning light that improves safety in the event of a vehicle breakdown or when doing road work
- a combination of a warning triangle and a work light in a single device
- rechargeable with a Li-Ion battery for repeated use without the need to change batteries
- 5 lighting modes for different situations
- suitable for cars, motorbikes and emergency kits
- warning triangle dimensions 270 × 50 × 245 mm



P4010



# COB LED camping lantern

- high light output
- simple 3× AA power supply for ease of use
- hook and magnet for flexible placement
- durable design, ideal for travel, home and workshop
- lantern dimensions 85 × 130 × 85 mm



P4006



# Electric insect light trap

- effective luring and elimination of insects using UV-A LED light without the use of chemicals
- silent running, suitable for use at home, on the patio or in a pergola
- practical design, hangable for flexible placement in the room
- mains power supply for continuous operation
- UV-A LED technology for a modern and energy-efficient solution
- suitable for the home, cottage and roofed outdoor spaces
- light trap dimensions 136 × 240 mm

P4104



3.3 w



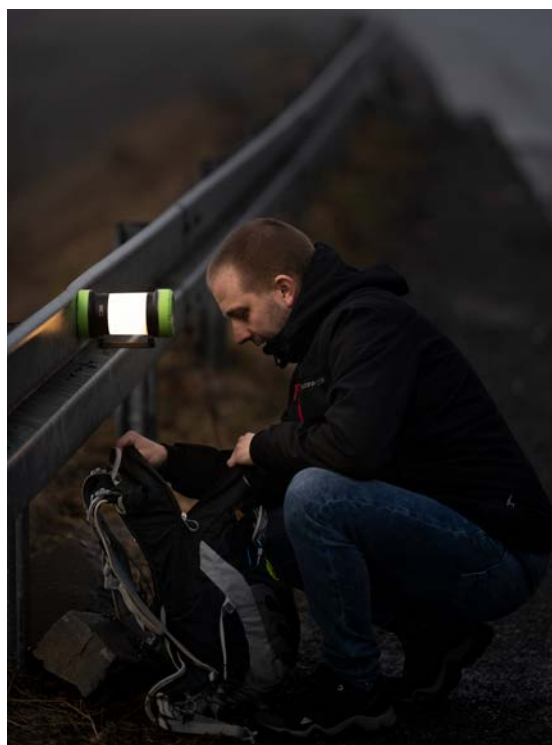
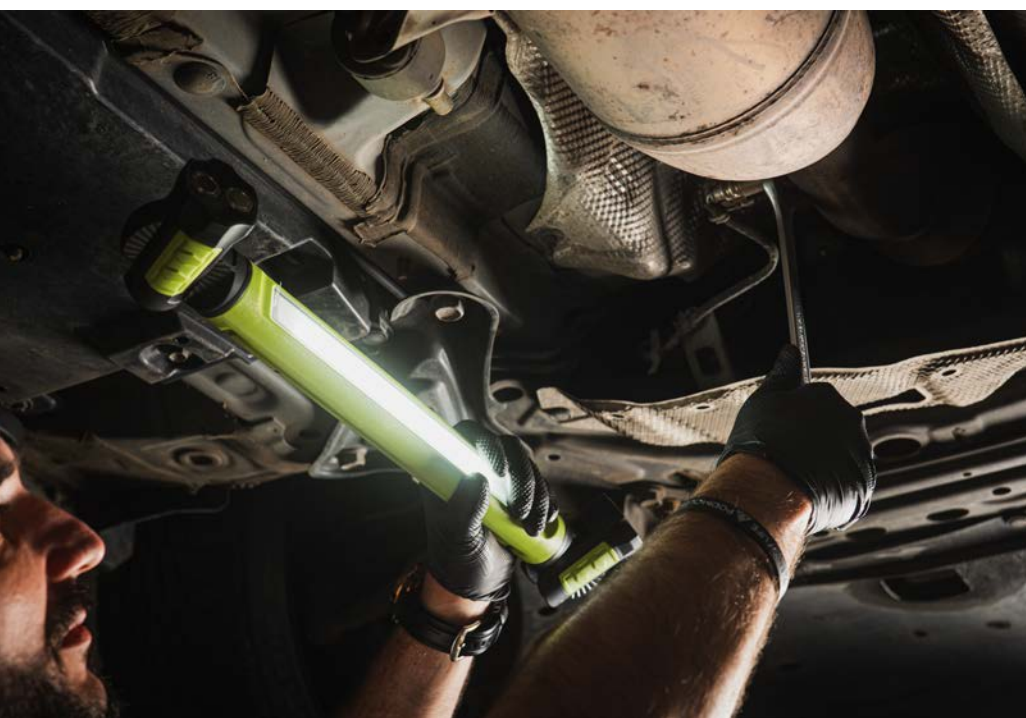

# Work lights

Work lights and floodlights are designed for professional use in assembly, servicing, maintenance and construction work. They offer high light output, multiple lighting modes and a sturdy body for reliable operation in demanding conditions.

The range includes both compact handheld models and powerful floodlights with a wide beam angle. Selected models feature a rechargeable Li-Ion accumulator with USB-C charging, battery protection and a quick-shutdown function. Practical features such as magnets, hooks or swivel handles allow for flexible hands-free use while working.

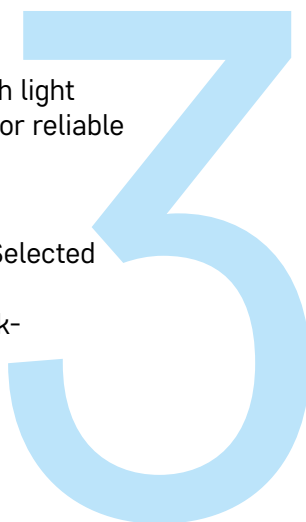

# LED work lights

- effective lighting of a large workspace
- selected models feature a hook and magnet for stable hands-free use
- compact body suitable for repairwork, installation and workshop use
- selected models feature a hook and magnet for stable hands-free use

 <p><b>P3888</b> 8 592920 028100</p> <p>3x AAA 180 lm 45 m Impact resistance</p>	 <p><b>P4531</b> 8 592920 072950</p> <p>RECHARGEABLE 3 LIGHTING MODES 400 lm 40 m Impact resistance Water resistance</p>	 <p><b>P4535</b> 8 592920 080078</p> <p>RECHARGEABLE 3 LIGHTING MODES 670 lm 40 m</p>
 <p><b>P4537</b> 8 592920 092408</p> <p>RECHARGEABLE 3 LIGHTING MODES 330 lm 45 m Impact resistance Water resistance</p>	 <p><b>P4538</b> 8 592920 092590</p> <p>RECHARGEABLE 3 LIGHTING MODES 700 lm 45 m light boost</p>	 <p><b>P4540</b> 8 592920 128961</p> <p>RECHARGEABLE 6 LIGHTING MODES 750 lm 35 m Impact resistance Water resistance</p>
 <p><b>P4544</b> 8 592920 134030</p> <p>RECHARGEABLE 3 LIGHTING MODES 800 lm 110 m Impact resistance Water resistance</p>	 <p><b>P4545</b> 8 592920 145654</p> <p>RECHARGEABLE 2 LIGHTING MODES 1 000 lm 40 m Water resistance Impact resistance 6 h COB</p>	 <p><b>P4546</b> 8 592920 157817</p> <p>RECHARGEABLE 3 LIGHTING MODES 500 lm 30 m 6 h Impact resistance Water resistance COB + LED</p>

# LED flashlights

- hand-held work flashlights for professional use (repair, installation, maintenance, fieldwork)
- high-performance LED/COB light sources with a long range
- multiple lighting modes for adapting to the task at hand
- rechargeable Li-Ion accumulator with modern USB-C charging
- battery protection function and, on selected torches, a quick-shutdown function
- practical features (magnet, hook, stand, tilting handle, tripod thread, LCD indicator)

RECHARGEABLE  
BATTERY PROTECTION  
2 LIGHTING MODES

300 lm → 370 m

162 mm  
100 mm

8 592920 107966 P2311

RECHARGEABLE  
7 LIGHTING MODES  
QUICK SWITCH OFF  
BATTERY PROTECTION

350 lm → 260 m  
Impact resistance  
Water resistance

175 mm  
91 mm

8 592920 119266 P2313

RECHARGEABLE  
4 LIGHTING MODES  
BATTERY PROTECTION

210 lm → 240 m

200 mm  
100 mm

8 592920 137147 P2314

RECHARGEABLE  
QUICK SWITCH OFF  
BATTERY PROTECTION  
COB + LED

700 lm → 370 m  
Impact resistance  
Water resistance

205 mm  
156 mm  
125 mm

8 592920 140567 P2315

RECHARGEABLE  
QUICK SWITCH OFF  
BATTERY PROTECTION  
COB + LED

850 lm → 400 m  
Impact resistance  
Water resistance

210 mm  
148 mm

8 592920 141670 P2316

RECHARGEABLE  
QUICK SWITCH OFF  
BATTERY PROTECTION  
COB + LED

1.000 lm → 500 m  
Impact resistance  
Water resistance

205 mm  
146 mm  
107 mm

8 592920 140581 P2317

# LED work floodlights

- high light output of up to 2,000 lm
- battery-powered and rechargeable versions
- multiple lighting modes
- selected models feature quick-shutdown and battery protection features
- swivel handle for flexible use

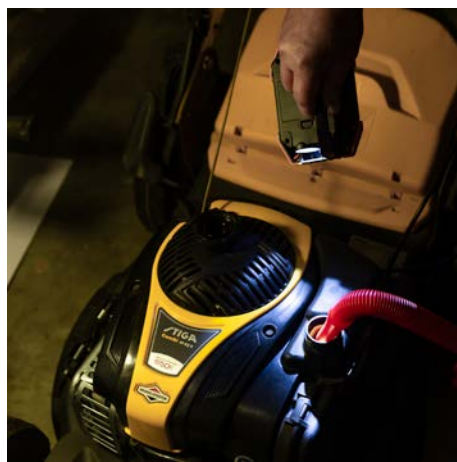

- 3x AA
- 2 LIGHTING MODES
- 350 lm
- 110 m

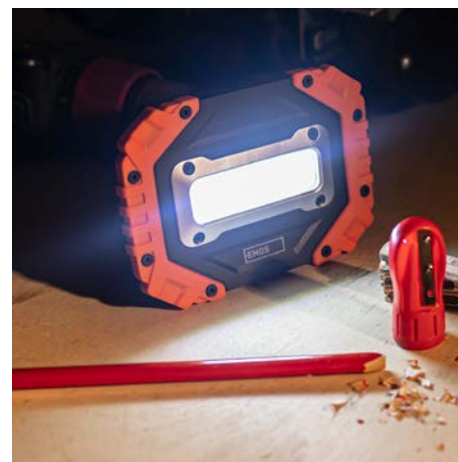

- 4x AA
- 3 LIGHTING MODES
- 700 lm
- 35 m
- Impact resistance
- Water resistance



- RECHARGEABLE
- 3 YEARS WARRANTY
- QUICK OFF / QUICK ON
- BATTERY PROTECTION / RECHARGE
- 1 000 lm
- 45 m
- Impact resistance
- Water resistance



- RECHARGEABLE
- 5 LIGHTING MODES
- QUICK OFF / QUICK ON
- BATTERY PROTECTION / RECHARGE
- 2 000 lm
- 70 m
- Impact resistance

# Comparison tables

## LED work lights

Common number	Light source	Maximum luminous flux	Maximum beam distance	No. of lighting modes	Runtime	Rechargeable	Special features and equipment	Dimensions in mm	Weight
P3888	COB LED	180 lm	45 m	2	16–24 h	no	hinged handle, 1× hook, 2× magnet	59 × 30 × 133	110 g
P4535	2× COB LED + LED	670 lm	40 m	3	2–10 h	yes	power bank, quick shutdown, battery protection, 1× hook, 4× magnet	35 × 33 × 257	225 g
P4531	COB LED + LED	400 lm	40 m	3	3–8.5 h	yes	quick shutdown, battery protection, rotary handle, clip, 1× hook, 1× magnet	52 × 32 × 165	196 g
P4540	COB LED + LED	750 lm	35 m	6	2–13 h	yes	quick shutdown, battery protection, rotary floodlight, magnet, hook	28 × 35 × 147/285	118 g
P4537	COB LED + LED	330 lm	45 m	3	3–7 h	yes	quick shutdown, battery protection, rotary tilting handle, 1× clip, magnet, hook	41 × 29 × 154	110 g
P4538	SMD LED + LED	700 lm	45 m	3	3–6 h	yes	battery protection, light BOOST, 2× magnet	37 × 14 × 240	100 g
P4544	COB LED + LED	800 lm	110 m	3	2.5–7 h	yes	quick shutdown, battery protection, power bank, rotary hinged handle, 2× hook, 2× magnet	50 × 50 × 255	325 g
P4545	COB LED	1,000 lm	40 m	2	2–6 h	yes	quick shutdown, battery protection, 2× rotary hinged handle, 2× hook, 4× magnet	50 × 46 × 500	490 g
P4546	COB LED + LED	500 lm	30 m	3	2.5–6 h	yes	quick shutdown, battery protection, rotary handle, 1× hook, 1× magnet	48 × 30 × 207	280 g

## LED flashlights

Common number	Maximum luminous flux	Maximum beam distance	No. of lighting modes	Runtime	Impact resistance	Water resistance	Charging time	Equipment and special features	Dimensions in mm	Weight
P2311	300 lm	370 m	2	24–30 h	no	no	4.5 h	battery protection	162 × 100 × 140	275 g
P2313	350 lm	260 m	7	5–23 h	yes	yes	7 h	power bank, quick shutdown, battery protection, tilting handle, 1× hook, 3× magnet	175 × 91	406 g
P2314	210 lm	240 m	4	3–6 h	no	no	3 h	quick shutdown, battery protection	200 × 100 × 100	281 g
P2315	700 lm	370 m	10+	4–11 h	yes	yes	4 h	quick shutdown, battery protection, power bank, swivel stand	205 × 125 × 156	500 g
P2317	1,000 lm	500 m	8+	10–22 h	yes	yes	10 h	power bank, quick shutdown, battery protection, LCD indication, tripod thread	205 × 102 × 148	781 g
P2316	850 lm	400 m	7+	7–18 h	yes	yes	6 h	power bank, quick shutdown, battery protection, LCD indication, tripod thread	210 × 107 × 148	688 g

## LED work floodlights

Common number	Light source	Maximum luminous flux	Maximum beam distance	No. of lighting modes	Runtime	Rechargeable	Special features and equipment	Dimensions in mm	Weight
P4113	COB LED	700 lm	35 m	3	8–14 h	no	quick shutdown, rotary handle	145 × 105 × 35	165 g
P4112	2× COB LED + LED	350 lm	110 m	2	10–20 h	no	rotary handle	135 × 100 × 40	140 g
P4533	COB LED	1,000 lm	45 m	3	3.5–15.5 h	yes	quick shutdown, battery protection, rotary handle	172 × 45 × 126	453 g
P4536	2× COB LED	2,000 lm	70 m	5	3.5–14.5 h	yes	quick shutdown, battery protection, rotary handle, 4× magnet	214 × 140 (280) × 56	818 g

The range of reels, extension cords and cable connectors offers a reliable solution for extending the reach of your power supply both indoors and outdoors. These products are designed to provide a safe power supply for electrical equipment when working in the garden, doing out maintenance around the house, and for temporary outdoor installations.

Cable reels allow you to extend the reach of electrical sockets and make it more convenient to use power tools or garden equipment. Extension cords in various lengths and designs expand the range of applications in both residential and commercial settings. Connectors ensure a secure and reliable interconnection of cables and help maintain a stable power supply.



# Power for outdoor spaces

1. Reels
2. Cable connectors
3. Outdoor sockets



# Reels

Our range of cable reels offers a reliable solution for safe and organised routing of power cables, both indoors and outdoors. Their sturdy body ensures a long life and reliable operation even in demanding conditions.

Practical design enables easy handling and efficient cable management when working in the garden, on a construction site or at the workplace. This category comprises a stable range of products with a wide range of applications in the residential and professional sectors.



# 1-phase reels with neoprene cable

- quality neoprene insulation for maximum durability and reliability
- resistant to water, extreme temperatures and oils
- integrated thermal fuse increases safety and protects the cable from overheating during heavy use
- stable stand, winding reel and rubberised handle for comfortable handling and easy installation

**5**  
YEARS  
WARRANTY



-25 °C ~ +60 °C



Oil resistance



Impact resistance



IP44



P19222



P19223



P19224



P08215



General number	Length	Dimension v mm	Wire cross-section	Number of sockets	Voltage	Current	Conductor	Cable color	Other features
<b>P19222</b>	25 m	285	1,5 mm <sup>2</sup>	4	230 V~	16 A	H07RN-F	black	guide eye, coil brake
<b>P19223</b>	50 m	285	1,5 mm <sup>2</sup>	4	230 V~	16 A	H07RN-F	black	guide eye, coil brake
<b>P19224</b>	40 m	263	2,5 mm <sup>2</sup>	4	230 V~	16 A	H07RN-F	black	guide eye, coil brake
<b>P08215</b>	15 m	247 × 157 × 310	1,5 mm <sup>2</sup>	4	230 V~	16 A	H07RN-F	black	LED spotlight 20 W/1 600 lm/6 500 K

# 1-phase reels with rubber cable

- rubber insulation for maximum durability and reliability
- resistant to water, extreme temperatures and oils
- integrated thermal fuse increases safety and protects the
- cable from overheating during heavy use
- stable stand, winding reel and rubberised handle

**3**  
YEARS  
WARRANTY



-25 °C ~ +60 °C



Impact  
resistant



IP44



P19625



8 592920 016152



P08225



8 595025 324924



P19221



8 592920 056974



P08250



8 595025 324931



P082251



8 592920 136379

General number	Length	Dimension in mm	Wire cross-section	Number of sockets	Voltage	Current	Conductor	Cable color	Other features
P19625	25 m	263,5	2,5 mm <sup>2</sup>	4	230 V~	16 A	H05RR-F3G	black	-
P08250	50 m	300	1,5 mm <sup>2</sup>	4	230 V~	16 A	H05RR-F3G	black	-
P19221	50 m	299	2,5 mm <sup>2</sup>	4	230 V~	15 A	H05RR-F3G	black	-
P082251	25 m	200	1,0 mm <sup>2</sup>	4	230 V~	10 A	H05RR-F3G	black	guide eye, coil brake
P08225	25 m	263,5	1,5 mm <sup>2</sup>	4	230 V~	16 A	H05RR-F3G	black	-

# 3-phase reels with neoprene cable

- waterproof (IP44), extreme temperature and oil resistant
- EMOS extension lead with thermal fuse
- stable stand, winding reel and rubberised handle



H07RN-F  
1.5 mm<sup>2</sup>

General number	Length	Dimension in mm	Wire cross-section	Number of sockets	Voltage	Current	Conductor	Cable color	Other features
P192250	25 m	298	1,5 mm <sup>2</sup>	1+2	230 V~/400 V~	13 A	H07RN-F5G	black	-
P19733	33 m	381	2,5 mm <sup>2</sup>	1+2	230 V~/400 V~	13 A	H07RN-F5G	black	-

# 1-phase reels and single socket extension cords with weatherproof PVC cable

- highly weatherproof insulation guarantees reliable operation even at extremely low temperatures
- the cable is resistant to water (IP44), extreme temperatures and oils, ensuring its long-term functionality in harsh conditions
- thermal fuse for increased safety and overheating protection
- stable stand, winding reel and rubberised handle for easy handling and comfortable use
- one model with integrated LED reflector + 2 usb



-35 °C ~ +60 °C



Oil resistance



Impact resistance



IP44



General number	Length	Dimension in mm	Wire cross-section	Number of sockets	Voltage	Current	Conductor	Cable color	Other features
P08620W	20 m	160 × 260 × 350	1,5 mm <sup>2</sup>	3	230 V~	13 A	AT-N05V3V3-F	blue	2× USB-A $\Sigma$ 2,1 A max.
P08625W	25 m	263	1,5 mm <sup>2</sup>	4	230 V~	16 A	AT-N05V3V3-F	blue	guide eye, coil brake
P08650W	50 m	320	1,5 mm <sup>2</sup>	4	230 V~	16 A	AT-N05V3V3-F	blue	guide eye, coil brake
P01520W	20 m	-	1,5 mm <sup>2</sup>	1	250 V~	16 A	AT-N05V3V3-F	blue	-
P01510W	10 m	-	1,5 mm <sup>2</sup>	1	250 V~	16 A	AT-N05V3V3-F	blue	-



# Cable connectors

This category encompasses electrical connectors and extension cords designed for the safe and reliable connection of power cables. The range is designed to ensure a stable connection and long-term operation both indoors and outdoors.

These products enable efficient installation and help ensure safe and uninterrupted power supply to electrical systems. This category features a range of complementary products with practical applications across our garden and electrical portfolio.



# Single socket extension cords with rubber insulation

- high-quality rubber cable ensures flexibility and durability even in harsh conditions
- available in different lengths for maximum flexibility in connection
- high load capacities up to 16 A / 3 680 W ideal for workshops, construction sites and gardens
- resistant to mechanical stress
- black colour, round socket with cover, children protection



General number	Length	Wire cross-section	Number of sockets	Voltage	Current	Conductor	Cable color	Child protection
<b>P0701</b>	10 m	1,5 mm <sup>2</sup>	2	230 V~	16 A	H05RR-F3G	black	yes
<b>P0702</b>	15 m	1,5 mm <sup>2</sup>	2	230 V~	16 A	H05RR-F3G	black	yes
<b>P0703</b>	20 m	1,5 mm <sup>2</sup>	2	230 V~	16 A	H05RR-F3G	black	yes
<b>P0704</b>	25 m	1,5 mm <sup>2</sup>	2	230 V~	16 A	H05RR-F3G	black	yes

# Single socket extension cords with rubber-neoprene insulation

- high mechanical resistance of the rubber/neoprene insulation
- IP rating suitable for outdoor use
- high load capacities up to 16 A / 3 680 W for trouble-free power supply of a wide range of garden equipment
- available in different lengths for maximum flexibility in connection
- flexible cables with quality insulation are easy to coil, resist kinking and facilitate storage and frequent handling
- black colour, round socket with cover, children protection



General number	Length	Wire cross-section	Number of sockets	Voltage	Current	Conductor	Cable color	Child protection
<b>P01825R</b>	25 m	2,5 mm <sup>2</sup>	1	230 V~	16 A	H07RN-F3G	black	yes
<b>P01810</b>	10 m	1,5 mm <sup>2</sup>	1	230 V~	16 A	H07RN-F3G	black	yes
<b>P01820</b>	20 m	1,5 mm <sup>2</sup>	1	230 V~	16 A	H07RN-F3G	black	yes
<b>P01830</b>	30 m	1,5 mm <sup>2</sup>	1	230 V~	16 A	H07RN-F3G	black	yes
<b>P01805</b>	5 m	1,5 mm <sup>2</sup>	1	230 V~	16 A	H07RN-F3G	black	yes
<b>P01810R</b>	10 m	2,5 mm <sup>2</sup>	1	230 V~	16 A	H07RN-F3G	black	yes



# Outdoor sockets

The range includes sockets designed for safe power supply in outdoor environments. Models with a durable moisture- and dust-resistant casing are suitable for installation in gardens, utility rooms and outside of buildings. Are available in versions with remote control and manual operation.

# 3



# Remote-controlled sockets

- convenient remote control of the sockets with a remot controller for maximum convenience
- durable IP44 rating protects against water, dust and harsh conditions
- elegant black design fits any exterior
- easy installation, quick connection and trouble-free operation



P0068



Energy saving

**13 A**  
**3 000 W**  
 max.



IP44



433.92 MHz



30 m

General number	Max. load	Number of sockets	Voltage	Current	Material	Colour	Child protection
P0068	3 000 W	1× 2P + PE	250 V~	13 A	plastic	black	yes

# Socket with switch

- manual operation via a button on the socket
- durable IP44 rating protects against water, dust and harsh conditions
- easy installation, quick connection and trouble-free operation
- ideal for controlling garden pumps, irrigation systems, light decorations or work tools



IP44

P00292



General number	Max. load	Number of sockets	Voltage	Current	Material	Colour	Child protection
P00292	3 680 W	1× 2P + PE	250 V~	16 A	plastic	black	yes

The Automation and Security category includes smart and practical solutions that will make your daily life easier, enhance the security of your home and bring greater comfort to your garden. From automated lighting and irrigation systems to reliable monitoring and protection – our products combine cutting-edge technology with simple installation and intuitive controls. Thanks to these smart tools, gardening will not only be safer, but also more effectively controlled and more energy-efficient.



# Automation and security

1. Sensors
2. Timers
3. Irrigation timers
4. Outdoor cameras
5. For pets



# Sensors

A practical and reliable solution for everyday use in the household and the garden. The range includes monitoring and automation products that enhance user comfort and contribute to more efficient management of the household, including pool thermometers for accurate monitoring of water temperature in swimming pools, hot tubs and ponds, and motion sensors for the automatic control of motion-activated outdoor lighting.



# Pool thermometer

- accurate measurement of the water temperature in a swimming pool, hot tub or pond
- can be used as a standalone pool thermometer
- compatible with selected EMOS wireless weather stations and thermometers
- expands the functionality of the weather station to include water temperature monitoring



2× AA

P00271



Common number	Designed for the following main unit models	Outdoor humidity indicator	Range in open space	Frequency	Operating temperature	Power supply	Dimensions in mm
<b>E00032</b>	E8610, E8614, E8620, E8625, E8636, E8647N, E8647W	no	up to 100 m	433 MHz	-40 °C to +70 °C, 0.1 °C resolution	2× 1.5 V AA (not included)	95 × 95 × 156

# PIR motion sensors

- automatic light switching ensures comfort, safety and energy savings
- wide detection angle covers a large area and reliably responds to movement
- high load capacity enables the connection of various types of lighting
- adjustable sensitivity and activation time allow the sensor to be adjusted to different needs

G1125



230 V~/  
50 Hz



G1120

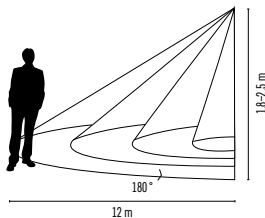
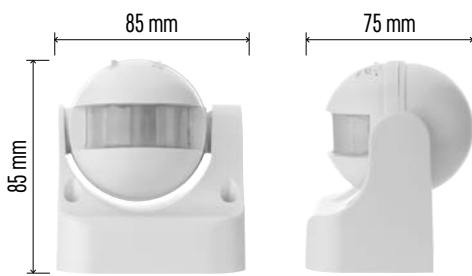

G1240



Common number	Colour	Detection angle	Detection range	Activation time	IP rating	Dimensions in mm
G1120	white	180°	12 m	min. 10 seconds – max. 15 minutes	IP44	85 × 75 × 85
G1125	black	180°	12 m	min. 10 seconds – max. 15 minutes	IP44	85 × 75 × 85
G1240	white	180°	12 m	min. 10 seconds – max. 15 minutes	IP65	75 × 65 × 65

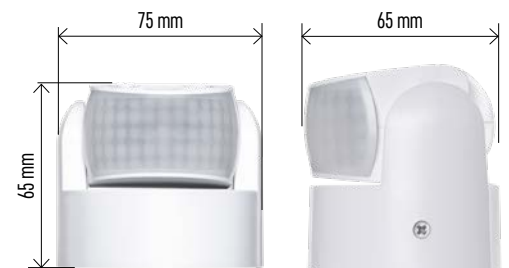



# Timers

Timer sockets offer an effective solution for controlling the operation of outdoor electrical equipment. The range includes both analogue versions and smart models with built-in energy consumption monitoring and the option to connect to the GoSmart system. These products enable users to set schedules for automatically switching connected devices on and off, thereby helping to optimise energy consumption and enhance user comfort. The range is ideal as a complementary product line for garden machinery, lighting and other outdoor applications.



# Switching sockets

- automatic switching of appliances according to set time intervals for maximum convenience and energy savings
- high load capacity allows control of a wide range of even the most demanding garden appliances
- wide operating temperature range (-25 °C to +50 °C) guarantees reliable functionality in all seasons
- ideal for automatic switching on and off of garden lights, switching on irrigation systems, operation of fountains and ponds or controlled heating of greenhouses



P5526N  
8 592920 117910



P5525N  
8 592920 134818



Energy saving



IP44

**3 680 W**  
max.



Phase L

General number	Type	Voltage/Current	Max. load	Switching time	Number of switching per day	Manual switching	Dimension in mm	Child protection
P5526N	mechanical	230 V~/16 A max.	3 680 W	30 minutes	48	no	58 × 128 × 87	yes
P5525N	digital	230 V~/16(2) A max.	3 680 W	1 minute	10	yes	86 × 63 × 136	yes



1× socket /  
Socket cover

LCD screen /  
Time display

Control buttons /  
Timer settings



# GoSmart sockets

- switch appliances on and off remotely using a mobile phone
- automate the operation of connected devices
- energy saving and real-time consumption monitoring for efficient use of electricity
- timer function allows precise settings without the need for manual intervention
- child lock for maximum safety and protection
- smart memory restores the last power on or off status of the device in the event of a power failure
- connectivity via Wi-Fi or Zigbee protocol



IP44

**3 680 W**  
max.



Timer



Countdown



Circulate



P5532



8 592920 122495



P5544



8 592920 131817



**ZigBee**

**3.0**



ON/OFF



Common number	Product	Voltage/current	Max. no. of sockets per Wi-Fi network	No. of operations per day	Number of programmes	Dimensions in mm
P5532	Wi-Fi timer/watt-meter – outdoor	230 V~/16 (5) A max.	15	30	30	58 × 81 × 58
P5534	ZigBee socket	230 V~/16 A max.	-	30	30	55 × 74 × 55



# Irrigation timers

# 3

A solution for the efficient management of outdoor irrigation, offering both manual control and automatic operation. The range enables you to optimise water consumption and simplify garden maintenance while ensuring consistent and uniform care for your greenery.

# GoSmart and manual irrigation timers

- smart control from anywhere for GoSmart-type irrigation timers
- irrigation scheduling according to daily requirements and current weather conditions
- selected models offer delayed watering function to save water and prevent plants from being overwatered
- simple installation and intuitive controls
- save time, money and energy



IP54

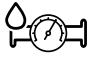

35 l/min max.



8 bar max.



PW56001



Powered by



BLE



PW56201

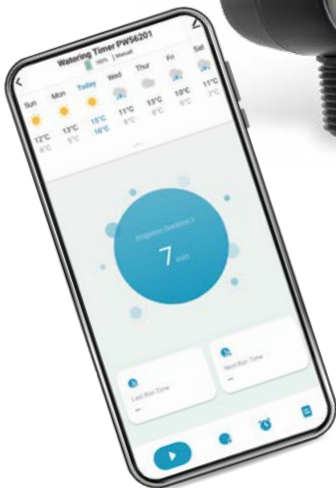

Schedule



Rain delay



Irrigation history



PW56202

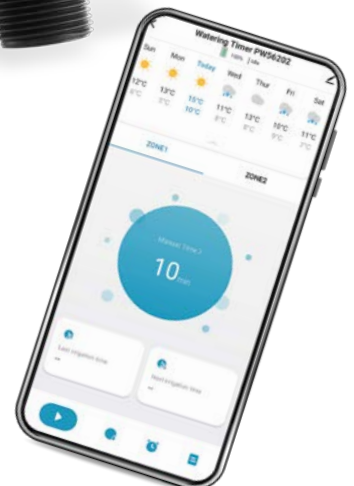

Common number	Watering frequency	Watering duration	Power supply	Dimensions in mm
PW56001	1-2-3-4-5-6-8-12-24-48-72 hours - 1 week	3-5-10-15-20-30-45-60-90-120 mins	2× 1.5 V AA (not included)	140 × 155 × 75
PW56201	unlimited	1 minute - 24 hours	4× 1.5 V AA (not included)	120 × 160 × 55
PW56202	unlimited	1 minute - 24 hours	4× 1.5 V AA (not included)	135 × 160 × 70



Powered by



# IP cameras

Modern security solutions for homes, businesses and outdoor areas, featuring high-definition video, night vision and intelligent motion detection with alerts sent to your mobile app. Thanks to Wi-Fi connectivity and integration with the EMOS GoSmart (Tuya) platform, these appliances enable easy control, live viewing and playback of recordings from anywhere; selected models offer person detection, motion tracking, two-way communication and an alarm, storage to a microSD card or the cloud, and a durable body with option of battery or solar power for reliable operation in various conditions.

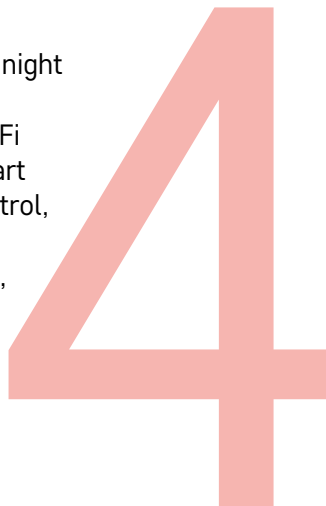

# GoSmart camera IP-600 EYE

- water-resistant body designed for the harshest weather conditions
- battery-powered operation with charging via an integrated solar panel
- siren for an even better security system
- two-way voice communication
- 3 Mpx resolution for detailed and high-quality recordings



**3MPx**

Resolution



Rechargeable  
8 800 mAh



Night  
vision



Motion  
detection



Solar  
charging



IP44

# GoSmart camera IP-1200 WASP

- 5 Mpx resolution for detailed and high-quality recordings
- motorised rotation and automatic motion tracking
- night vision and smart person and sound detection
- two-way communication for remote monitoring and response
- solar and battery power for flexible installation

H4067



**5MPx**

Resolution



Rechargeable  
9 200 mAh



Night  
vision



Motion  
detection



Solar  
charging



IP44

# GoSmart camera IP-1150 SNAP

- 5 Mpx resolution for a sharp and detailed image
- wide 135° angle lens for covering a larger area
- night vision and smart motion and sound detection
- two-way communication for remote monitoring
- solar and battery power for easy installation

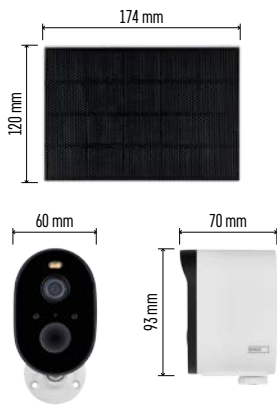

H4073



**5MPx**

Resolution



Rechargeable  
5 200 mAh



Night vision



Advanced detection



Solar charging



IP44

# GoSmart camera IP-1300 LANTERN

- 4 Mpx resolution for a high-quality and detailed image
- motorised rotation and automatic motion tracking
- night vision and intelligent person detection
- two-way communication for remote monitoring
- Dual Band Wi-Fi and IP55 rating for outdoor use

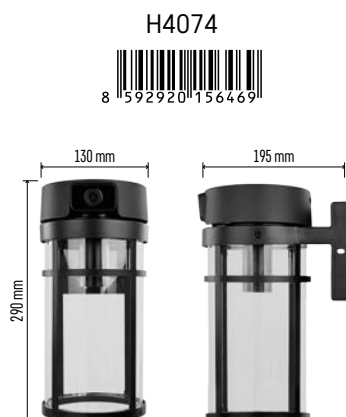
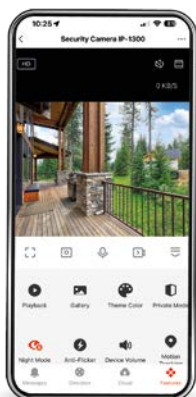

**4MPx**

resolution



Rechargeable  
9 200 mAh



Solar charging



IP44



E27



Outdoor

Common number	Installation	Camera power supply	Dimensions in mm	Motion detection angle	IP rating	Motion detection	Sound detection	IR CUT	Siren	Protocol
H4056	onto a wall	4×18650 batteries 2,200 mAh + solar panel + DC adapter 5 V/1 A (included)	140×235×100	110°	IP44	yes	-	yes	yes	Wi-Fi + Bluetooth
H4067	onto a wall	9,200 mAh + solar panel	140×188×388	135°	IP44	yes	yes	yes	yes	Wi-Fi
H4073	onto a wall + free-standing	5,200 mAh + solar panel	140×188×388	135°	IP44	yes	yes	yes	yes	Wi-Fi
H4074	onto a wall	AC 100~240 V	140×188×388	110°	IP55	yes	-	yes	yes	Wi-Fi



EMOS GoSmart

Powered by



Wi Fi

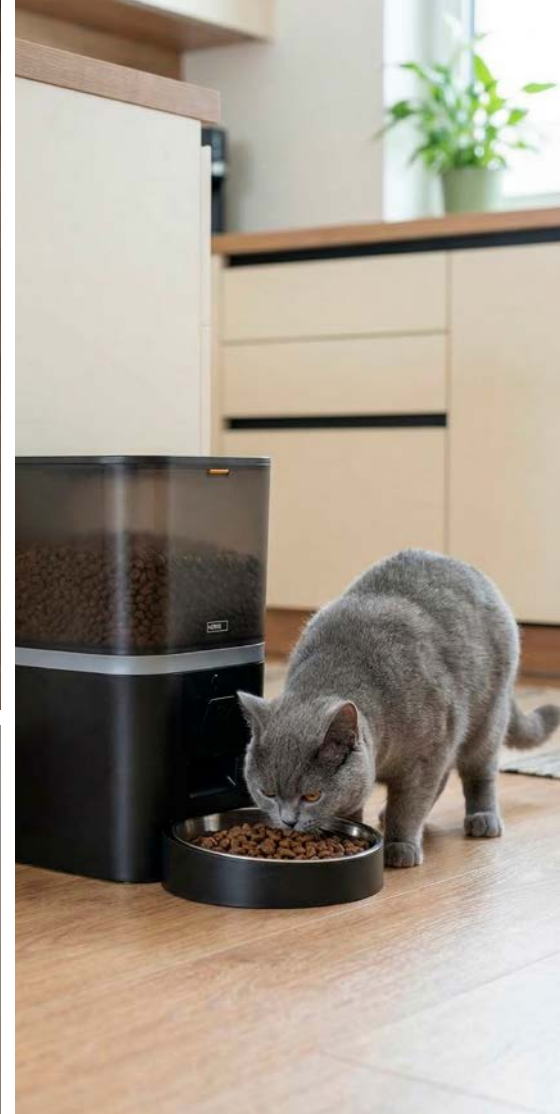

# For pets

Smart pet care products offer greater convenience, better control and a simpler daily routine. The GoSmart range includes automatic feeders, feeders with cameras, water fountains as well as accessories that enhance the functionality and extend the life of the devices; Wi-Fi and mobile app make it possible to schedule feeding, monitor the status and receive real-time alerts. The products are designed for everyday use, with a focus on hygiene, ease of maintenance and reliability, and feature elements such as stainless steel bowls, water filtration, food monitoring, a backup power supply and an integrated camera for remote monitoring.



# GoSmart feeders

- smart control via Wi-Fi and the EMOS GoSmart / TUYA mobile app
- automatic feeding scheduling for a regular and controlled regimen
- precise serving measurement for better control of food intake – pellet diameter 2–15 mm / one serving 5 g
- dual power supply for greater operational reliability even in the event of a power cut
- for indoor use only
- hygienic design with a removable stainless steel bowl, easy maintenance



H6002



Stuck food alarm



Voice recording



Low battery warning



Schedule



Dual power



Food level sensor



H6004



H6006



Common number	Capacity	Dimensions in mm	Power supply	Recommendation	Night vision	Motion detection	Sound detection	Maximum camera angle of view
H6002	4 l	315 × 314 × 168	5 V / 1 A / 3 × 1.5 V type D	small and medium-sized breeds	–	–	–	–
H6004	4 l	315 × 314 × 168	5 V / 1 A / 3 × 1.5 V type D	small and medium-sized breeds	yes, max. 5 m	yes	no	118°
H6006	6 l	190 × 210 × 325	5 V/1 A / 4 × 1.5 V type AA	medium-sized and large breeds	yes, max. 5 m	yes	no	117°

# GoSmart water fountain

- continuous water circulation and filtration for fresh, clean water
- smart reminders in the mobile app for filter replacement and maintenance
- silent running, suitable for everyday use in the household
- 2.6 l capacity, ideal for small and medium-sized dogs and cats
- Wi-Fi connection and control via the EMOS GoSmart / TUYA app
- rich package contents: fountain, power adapter, power cable, pump, filter for the pump, cotton filter, cleaning brush



Filter alarm



Water alarm



Purifying system



Silent operation



360° stream



USB 5 V

H6102



8 592920 138762

## Accessories for water fountain

- multi-stage filtration for clean and fresh water
- set of 4 filters for long-term use
- easy maintenance of the water fountain

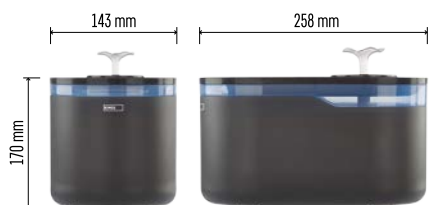

H6903



8 592920 141335



Common number	Capacity	Dimensions in mm	Power supply	Recommendation	Other features	Voice communication
H6102	2.6 l	259 × 143 × 170	5 V / 1 A	small and medium-sized breeds	water filtration, notifications for filter replacement	no



H6901



8 592920 138786

A man in a grey long-sleeved shirt and khaki pants is standing in a well-organized workshop, focused on working with several colorful cables on a wooden workbench. The workshop is filled with tools, including wrenches and pliers hanging on a pegboard, and various storage bins and equipment on shelves. A window on the right side of the frame provides natural light. The overall scene depicts a professional or hobbyist engaged in technical work.

The range includes cable accessories such as connectors and cable ties, as well as various types of technical tape for installation, insulation and repairs. These products help to ensure secure connections, safe installation and long-term functionality of electrical and technical systems, both indoors and outdoors. Thanks to their versatility, they offer a practical solution for a wide range of applications.

# MOUNTING AND FIXING SOLUTIONS

1. Cable accessories
2. Tapes



# Cable accessories

Practical and reliable solutions for securing, organising and interconnecting cables in electrical installation applications. The range includes screwless terminals, terminal blocks, cable clips, self-adhesive feet and cable ties for quick and easy installation and neat cable routing. The products emphasise ease of use, secure fastening, durable materials and safe operation; thanks to the range of options available, they are suitable for both professional and general installation and maintenance work.



# Cable ties

- a wide range of sizes
- tensile strength of 8 kg to 55 kg
- PA66 nylon – a professional-grade material
- self-locking one-way tightening mechanism
- self-extinguishing design in accordance with UL94
- black version with UV protection
- range of operating temperatures from -40 °C to +85 °C
- zip-lock bag – made from 100 % recycled plastic

**PA66**

Nylon



Common number	No. of pcs per pack	Dimensions in mm	Colour	UV protection	Tensile strength	Maximum diameter
A2841	100	2.5 × 100	black	yes	8 kg	22 mm
A2842	100	2.5 × 100	white	no	8 kg	22 mm
A2843	100	3.5 × 150	black	yes	18 kg	35 mm
A2844	100	3.5 × 150	white	no	18 kg	35 mm
A2845	100	3.5 × 200	black	yes	18 kg	53 mm
A2846	100	3.5 × 200	white	no	18 kg	53 mm
A2847	100	3.5 × 300	black	yes	18 kg	80 mm
A2848	100	3.5 × 300	white	no	18 kg	80 mm
A2849	100	4.8 × 200	black	no	22 kg	53 mm
A2850	100	4.8 × 200	white	no	22 kg	53 mm
A2851	100	4.8 × 250	black	yes	22 kg	65 mm
A2852	100	4.8 × 250	white	no	22 kg	65 mm
A2853	100	4.8 × 300	black	yes	22 kg	82 mm
A2854	100	4.8 × 300	white	no	22 kg	82 mm
A2855	100	4.8 × 350	black	yes	22 kg	90 mm
A2856	100	4.8 × 350	white	no	22 kg	90 mm
A2857	25	7.6 × 450	black	yes	55 kg	125 mm
A2858	25	7.6 × 450	white	no	55 kg	125 mm

A2841	A2850
A2842	A2851
A2843	A2852
A2844	A2853
A2845	A2854
A2846	A2855
A2847	A2856
A2848	A2857
A2849	A2858

# Self-adhesive feet (3M)

- genuine 3M™ adhesive tape
- durable ABS material
- range of operating temperatures from -40 °C to +80 °C
- can be screwed down afterwards
- compatible with cable ties
- black models feature UV protection
- in a bag made from 100 % recycled plastic

**3M  
TAPE**  
mounting

**ABS**  
Durable  
plastic

**Ta**   
-40–+80 °C

A2831



A2832



A2833



A2834



Common number	No. of pcs per pack	Dimensions in mm	Colour	UV protection
A2831	25	20 × 20	black	yes
A2832	25	20 × 20	white	no
A2833	25	30 × 30	black	yes
A2834	25	30 × 30	white	no

# Hammer-in cable clip

- durable plastic material
- clip dimensions 7.9 × 3.6 mm
- steel, corrosion-resistant nail
- various sizes for different cable diameters
- quick and easy installation
- range of operating temperatures from -40 °C to +85 °C
- in a bag made from 100 % recycled plastic

**PE**

Polyethylene



-40 – +85 °C



Impact resistance



A2822

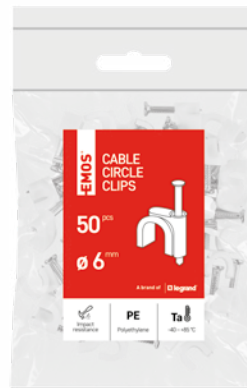

A2821



A2823



A2824



A2825



Common number	No. of pcs per pack	Cable diameter	Colour	UV protection
A2821	50	6 mm	black	yes
A2822	50	6 mm	white	no
A2823	50	8 mm	black	yes
A2824	50	8 mm	white	no
A2825	50	10 mm	black	yes
A2826	50	10 mm	white	no



A2826



# Terminal blocks

- brass body for maximum corrosion resistance
- a durable case made from high-quality white polypropylene
- high mechanical stability
- a wide range of terminal blocks for cable sizes from 2.5 mm<sup>2</sup> to 10 mm<sup>2</sup>
- quick and easy operation
- length of stripped wire: 10 mm
- range of operating temperatures from -30 °C to +85 °C

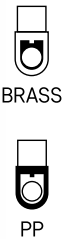

A4101



A4102



A4105

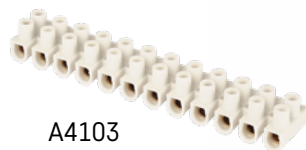

A4103



A4106

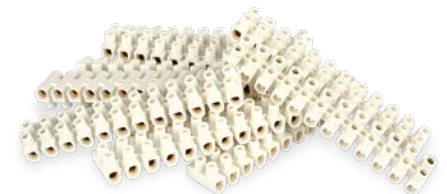
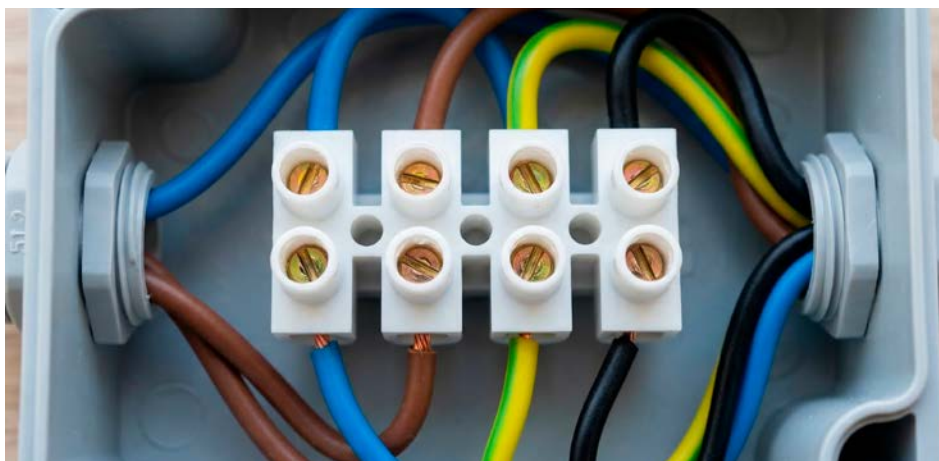

A4107



Common number	No. of units per pack	For cable cross-section	Nominal current	Nominal voltage	Hole diameter	Dimensions in mm
A4101	1	2.5-4 mm <sup>2</sup>	32 A	400 V ~	3.1 mm	91.6 × 15.6 × 12
A4102	1	4-6 mm <sup>2</sup>	41 A	400 V ~	3.6 mm	110.9 × 15.8 × 14.2
A4103	1	6-10 mm <sup>2</sup>	57 A	400 V ~	4.5 mm	118 × 20.2 × 16.5
A4105	10	1-4 mm <sup>2</sup>	32 A	400 V ~	3.1 mm	91.6 × 15.6 × 12
A4106	10	4-6 mm <sup>2</sup>	41 A	400 V ~	3.6 mm	110.9 × 15.8 × 14.2
A4107	10	6-10 mm <sup>2</sup>	57 A	400 V ~	4.5 mm	118 × 20.2 × 16.5

# Side and straight splicing connectors with lever, push-in connector

- screwless technology
- time savings during installation
- maintenance-free solution
- suitable for both solid and stranded wires
- length of stripped wire: 10 mm
- range of operating temperatures from -10 °C to +85 °C
- zip-lock bag – made from 100 % recycled plastic

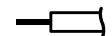

SOLID  
0,2–4 mm<sup>2</sup>

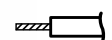

STRANDED  
0,2–2,5 mm<sup>2</sup>

**In/Ui**

max.  
32 A/450 V



A9101



A9102



A9103



A9104



A9111



A9112



A9113



Common no.	Use	Pack of	For cable cross-section	Dimensions in mm	No. of connectors	Stripped wire length
A9101	side	10	0,2–4 mm <sup>2</sup>	13,2 × 20,1 × 9,2 mm	2	12 mm
A9102	side	10	0,2–4 mm <sup>2</sup>	18,8 × 20,1 × 9,2 mm	3	12 mm
A9103	side	10	0,2–4 mm <sup>2</sup>	24,4 × 20,1 × 9,2 mm	4	12 mm
A9104	side	10	0,2–4 mm <sup>2</sup>	30,3 × 20,1 × 9,2 mm	5	12 mm
A9111	straight	10	0,2–4 mm <sup>2</sup>	39,3 × 10 × 8,3 mm	1+1	12–13 mm
A9112	straight	10	0,2–4 mm <sup>2</sup>	39,3 × 10 × 14,9 mm	2	12–13 mm
A9113	straight	10	0,2–4 mm <sup>2</sup>	39,3 × 10 × 22,9 mm	3	12–13 mm
A9121	straight	10	0,5–2,5 mm <sup>2</sup>	15,3 × 7,85 × 18,8 mm	3	11 mm

A9121



SOLID  
0,5–2,5 mm<sup>2</sup>

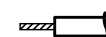

STRANDED  
0,5–2,5 mm<sup>2</sup>

**In/Ui**

max.  
24 A/450 V

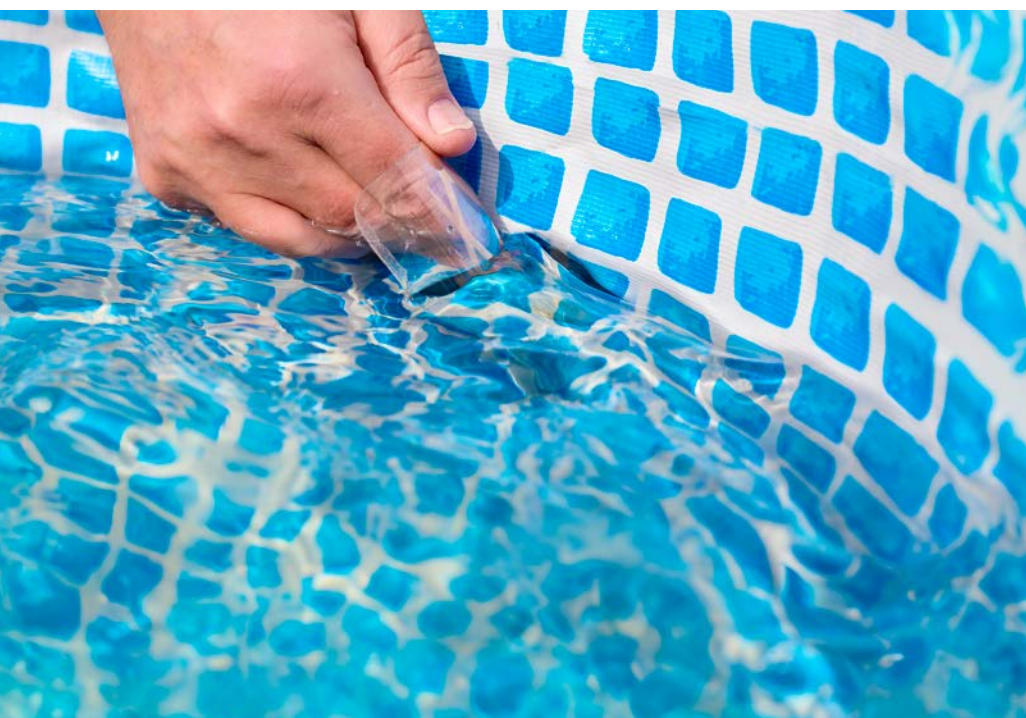

# Tapes

Our range of tapes offers a practical solution for a wide spectrum of gardening and installation applications, and includes various types, widths and colours for affixing, repair and specific installation projects. The products are designed for reliable outdoor use and form a stable complementary range with year-round marketability for both the hobby and professional sectors.

- Insulation PVC tapes
- NANO tapes
- Duct tapes
- Hobby tapes
- Repair tapes
- Double-sided tapes
- Acrylic tapes
- Self-amalgamating tapes
- Marking tapes



# Insulation PVC tapes

- high durability protects against moisture, dust and mechanical damage
- excellent insulation ensures safe conduction of electrical current
- their strong adhesion makes them suitable for various types of surfaces
- the flexible material easily adapts to the shape of the cables and joints
- suitable for use over a wide temperature range
- resistant to ageing and UV radiation
- the non-flammable material minimises the risk of fire
- a wide range of colours for easy identification of wires and cables
- ideal for repairs and insulation of garden electrical installations, colour-coding of garden features, tying up plants and saplings, temporarily affixing of materials



F615992



F61590



F61511



F61512



F61513



F61514



F61515



F61516



F61517



F61519



Common number	Tape colour	Tape width	Tape length	Waterproof joint	UV resistance	Electrical strength	Installation temperature range	Adhesive material
F61511	white	15 mm	10 m	yes	yes	40 kV/mm	-25-90 °C	rubber
F61512	black	15 mm	10 m	yes	yes	40 kV/mm	-25-90 °C	rubber
F61513	red	15 mm	10 m	yes	yes	40 kV/mm	-25-90 °C	rubber
F61517	Brown	15 mm	10 m	yes	yes	40 kV/mm	-25-90 °C	rubber
F61590	mix of colours	15 mm	8 m	yes	yes	2.5 kV/mm	0-80 °C	rubber
F615992	mix of colours	15 mm	10 m	yes	yes	40 kV/mm	-25-90 °C	rubber
F61514	blue	15 mm	10 m	yes	yes	40 kV/mm	-25-90 °C	rubber
F61519	green	15 mm	10 m	yes	yes	40 kV/mm	-25-90 °C	rubber
F61515	green/yellow	15 mm	10 m	yes	yes	40 kV/mm	-25-90 °C	rubber
F61516	yellow	15 mm	10 m	yes	yes	40 kV/mm	-25-90 °C	rubber

# Insulation PVC tapes



Common number	Tape colour	Tape width	Tape length	Waterproof joint	UV resistance	Electrical strength	Installation temperature range	Adhesive material
F61921	white	19 mm	20 m	yes	yes	40 kV/mm	-25-90 °C	rubber
F61922	black	19 mm	20 m	yes	yes	40 kV/mm	-25-90 °C	rubber
F62512	black	25 mm	10 m	yes	yes	40 kV/mm	-25-90 °C	rubber
F61923	red	19 mm	20 m	yes	yes	40 kV/mm	-25-90 °C	rubber
F61927	brown	19 mm	20 m	yes	yes	40 kV/mm	-25-90 °C	rubber
F61912	black	19 mm	10 m	yes	yes	40 kV/mm	-25-90 °C	rubber
F61999	mix of colours	19 mm	20 m	yes	yes	40 kV/mm	-25-90 °C	rubber
F61924	blue	19 mm	20 m	yes	yes	40 kV/mm	-25-90 °C	rubber
F61929	green	19 mm	20 m	yes	yes	40 kV/mm	-25-90 °C	rubber
F61925	green/yellow	19 mm	20 m	yes	yes	40 kV/mm	-25-90 °C	rubber
F61926	yellow	19 mm	20 m	yes	yes	40 kV/mm	-25-90 °C	rubber

# Pool tapes

- high adhesiveness underwater without the need to drain the pool
- high UV resistance when exposed to sunlight
- resistant to both high and low temperatures
- suitable for various types of materials, including PVC swimming pool liners
- very easy to install
- ideal for quick repairs to swimming pools, ponds, rainwater barrels and cisterns, inflatable mattresses or swimming aids



Common number	Tape colour	Tape width	Roll length	Waterproof joint	UV resistance	Installation temperature range	Adhesive material
<b>F6100</b>	transparent	100 mm	1 m	yes	yes	-25-90 °C	synthetic adhesive
<b>F6110</b>	black	100 mm	1 m	yes	yes	-25-90 °C	synthetic adhesive

# Greenhouse tape

- highly adhesive
- resistant to rain, wind and extreme temperatures
- transparent design for discreet repairs without spoiling the appearance of the greenhouse
- easy to install on both smooth and uneven surfaces, including polycarbonate and glass
- compact tape size, even for larger repairs
- the tape's high-quality material ensures a strong and durable bond that lasts for a long time
- ideal for repairing greenhouses, windows, canopies, polytunnels, hotbeds and other transparent surfaces



Common number	Tape colour	Tape width	Roll length	Waterproof joint	UV resistance	Installation temperature range	Adhesive material
<b>F6200</b>	transparent	50 mm	25 m	-	yes	-25-90 °C	acrylic

# Fabric tapes

- versatile use for reinforcing, repairing, sealing and binding materials
- asphalt fabric tapes with long life and lasting strength
- reliable protection against humidity, rain and sunlight
- suitable for mechanically stressed joints and surfaces; for small electrical installations
- constant flexibility even under heavy use
- easy unwinding, tearing and application of to various materials
- ideal for reinforcing cracked handles on gardening tools, securing and tying up cables and hoses, gently securing plants and saplings to stakes without damaging the bark or stems, and wrapping sharp edges



Common number	Tape colour	Tape width	Roll length	Waterproof joint	UV resistance	Installation temperature range	Adhesive material
<b>F6910</b>	black	19 mm	10 m	no	yes	5-40 °C	asphalt
<b>F6515</b>	black	15 mm	15 m	no	yes	5-40 °C	asphalt

# Marking tape

- highly visible thanks to its red and white hatching, instantly recognisable even in poor visibility
- weather-resistant
- handy cardboard dispenser prevents tangling and facilitates handling
- lightweight yet durable material for a long life
- ideal for marking out flower beds, paths and work areas



Common number	Tape colour	Tape width	Roll length	Waterproof joint	UV resistance	Installation temperature range	Adhesive material
<b>F87525</b>	red/white	75 mm	250 m	no	yes	5-30 °C	no adhesive

# Double-sided foam tape

- provides a strong and durable bond between various materials
- foam structure makes the tape able to adapt to uneven surfaces
- effectively absorbs shocks and vibrations, making it ideal for sensitive applications
- moisture- and chemical-resistant
- easy installation
- ability to withstand high temperatures without losing adhesiveness
- enables clean and invisible joints; suitable for decorative and design applications
- ideal for affixing garden decorations, solar lights, ornaments and other small items to various surfaces, fixing signs, and mounting holders for gardening tools to walls or fences



Common number	Tape colour	Tape width	Roll length	Waterproof joint	UV resistance	Installation temperature range	Adhesive material
<b>F6090</b>	white	20 mm	3 m	no	-	5-80 °C	acrylic

# Double-sided nano tapes

- suitable for various surfaces, including wood, glass and metal
- the innovative gel material offers high strength and flexibility
- can be reused after rinsing with lukewarm water
- leave no trace once removed
- ideal for attaching garden decorations and solar lights, making quick repairs to cracked or damaged garden furniture, and securing hoses or pipes from irrigation systems to walls or other surfaces

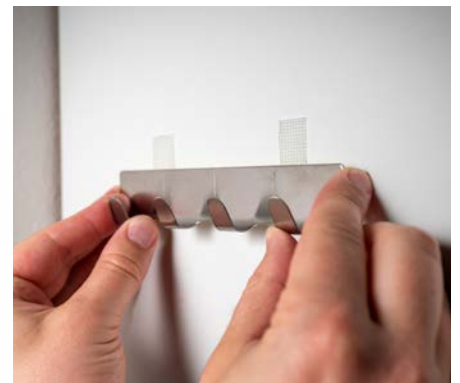
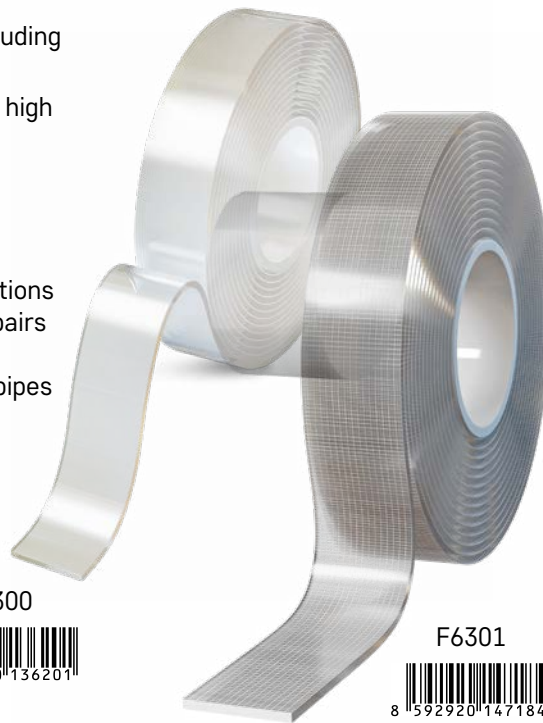

Common number	Tape colour	Tape width	Roll length	Waterproof joint	UV resistance	Installation temperature range	Adhesive material
<b>F6300</b>	transparent	30 mm	3 m	-	-	5-80 °C	acrylic
<b>F6301</b>	transparent	19 mm	3 m	-	-	5-80 °C	acrylic

# Double-sided acrylic tapes

- acrylic adhesive offers long life and resistance to solvents
- ensure a strong and durable bond
- resistant to high temperatures and UV radiation, ensuring long life
- manual pressure is sufficient to create a high-quality joint, without the need for special tools
- exceptional adhesion to all uneven surfaces
- ideal for securing protective nets against birds or insects, mounting wireless doorbells and decorations, and attaching garden hose holders

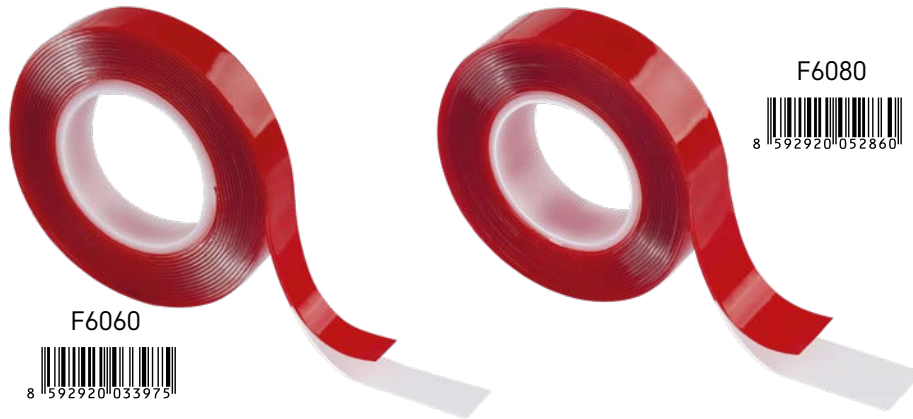

Common number	Tape colour	Tape width	Roll length	Waterproof joint	UV resistance	Installation temperature range	Adhesive material
<b>F6060</b>	transparent	12 mm	3 m	-	yes	5-40 °C	acrylic
<b>F6080</b>	transparent	18 mm	3 m	-	yes	5-40 °C	acrylic

# Reflective tapes

- strongly reflect light back towards the source, making them easily visible even in low light
- reflective elements can make an object or a person visible from a distance of up to 200 metres
- self-adhesive and flexible for easy application to various surfaces
- available in silver, yellow, orange and red
- ideal for marking garden paths and walkways, making safety markings on garden furniture, marking the edges of flower beds, and making safety markings on fences



Common number	Tape colour	Tape width	Roll length	Waterproof joint	UV resistance	Installation temperature range	Adhesive material
<b>F6070</b>	mix of colours	25 mm	2 m	-	yes	-25-90 °C	rubber

# Insect screen repair tape

- a quick and effective solution for repairing tears in window screens
- designed to allow adequate air circulation
- provides firm support for torn materials
- long-lasting, reliable adhesion to the damaged surface
- suitable for repairing all types of mosquito nets, tears in nets on gazebos and pergolas, and insect screens on windows, balconies and doors

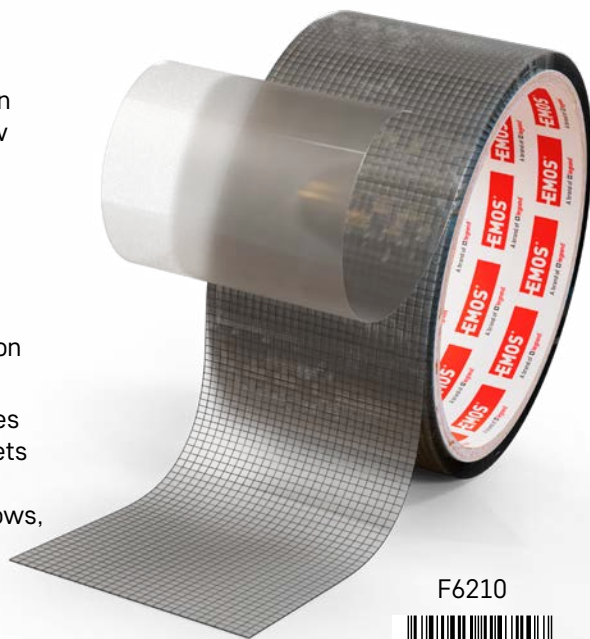

F6210



Common number	Tape colour	Tape width	Roll length	Waterproof joint	UV resistance	Installation temperature range	Adhesive material
<b>F6210</b>	transparent	50 mm	2 m	-	yes	5-80 °C	hot melt

# Duct tapes

- suitable for emergency repairs and installations both indoors and outdoors
- easy to tear by hand without the need for scissors
- resistant to moisture, sunlight and temperature fluctuations
- versatile use on various surfaces, including pipes, insulation, tarpaulins and tents
- ideal for quick repairs to garden furniture, securing garden hoses, mending tarpaulins and tents, repairing gardening tools, and fixing damaged sections of fences or gates



F6030



F6302



Common number	Tape colour	Tape width	Roll length	Waterproof joint	UV resistance	Installation temperature range	Adhesive material
<b>F6030</b>	silver	48 mm	10 m	-	yes	5-80 °C	synthetic rubber
<b>F6302</b>	transparent	48 mm	10 m	-	no	5-80 °C	hot melt

# Self-amalgamating tapes

- create a watertight seal, ideal for repairing pipes and hoses
- provide strong electrical insulation
- the tape shrinks on its own and fits tightly around the repaired surface
- suitable for repairing electrical cables, pressure hoses, pipes and other cracked surfaces
- also available in a silicone version for extreme conditions



Common number	Tape colour	Tape width	Tape length	Waterproof joint	UV resistance	Installation temperature range	Adhesive material
<b>F51912</b>	black	19 mm	10 m	yes	-	5-95 °C	rubber
<b>F52502</b>	black	25 mm	5 m	yes	-	5-95 °C	rubber
<b>F52503</b>	black	25 mm	3 m	yes	yes	-60-260 °C	no adhesive

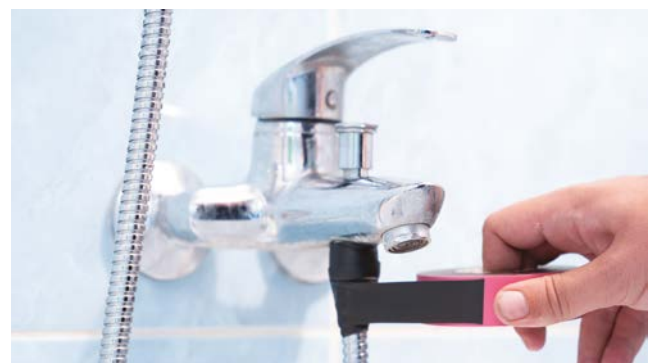









**EMOS spol. s r.o.**

Lipnická 2844

750 02 Přerov

e-mail: [emos@emos.cz](mailto:emos@emos.cz)

telephone: +420 581 261 111

**[www.emos.eu](http://www.emos.eu)**

Y11426



**35** years of  
**#EMotions**

**Making Life Easy**