



**EMOS**<sup>®</sup>

A brand of **legrand**<sup>®</sup>

# Product Catalogue 2024/2025



GoSmart		Home security	Luminaires and light sources	Wiring and control	Measurement and control	Household and garden				
Batteries		GP				RAVER				EMOS
		Alkaline	Carbon zinc	Other	Rechargeable	Lithium	Alkaline	Rechargeable	Other	Lead acid batteries
Battery chargers, powerbanks, USB chargers		Battery chargers	Powerbanks	USB chargers	Universal adaptors	Car battery chargers, testers				
Portable lighting		GP	EMOS							
Lighting	Light sources	LED bulbs	Light bulbs for electrical appliances	ECO halogen	LED tubes, tubes					
	Luminaires	Highbays	Dustproofs	Street lights	Floodlights	Work lights	Linear luminaires	LED panels	Drivers	Surface luminaires
			Pendant luminaires	Recessed luminaires	Emergency luminaires	Orientation luminaires	Cabinet luminaires	Desk and floor lamps	Sensors	Decorations
Weather stations, thermometers, scales, others		Weather stations	Thermometers	Spare sensors	Kitchen, hanging scales	Kitchen timers	Personal scales	Air quality GoSmart	Bathroom scales GoSmart	
TV and audio accessories		Multimedia players, radios	TV wall mounts	Universal remote controllers OFA						
Power supply extension cords, cable reels, plugs, accessories		Power supply extension cords and sockets	Surge protectors	Assembled cords	Cable reels	Sockets, plugs, adaptors, timers, others	Industrial plugs, 380 V sockets	Flexo, assembled cords		
Cables		Data cables UTP, FTP	Connectors, patch accessories	Twin-shielded cables CYH	Coaxial cables	Connection AV cables	Smartphone cables	Solid, flexible cables	Solar cables	
HF signal receiving components, antennas, small electronic, accessories		Antennas	TV signal receivers	Wall sockets	Accessories					
Videophones, doorbells		Home videophones, sets	Cameras, surveillance	Doorbells	Sensors GoSmart					
Multimeters, testers		Multimeters, measuring cables	Testers	Measuring instruments						
Thermostats, CO and smoke alarms		Thermostats	CO and smoke alarms	Valve closer GoSmart	Detectors GoSmart					
Installation material, tapes		Installation material	Tapes							





## **PERSON and PRODUCT**

*„The product is a mirror of our needs  
and our desire to make life easier.“*

# EMOS®

A brand of  **legrand®**

## Making life easy

Specialist in small household electronics! We enjoy developing, sourcing, and delivering electrical products that help our business partners succeed in today's highly competitive marketplace with their optimum price and quality.

For over 30 years, EMOS companies have offered small household electrical products that are part of everyone's life. Under the EMOS brand, there are mainly batteries, light sources, luminaires for domestic and industrial use, extension leads, flashlights, antennas and small electronic devices – multimeters, testers and bells. In five countries, there are over 450 people employed to ensure that our products are of the best quality and get delivered to you, our customers, as quickly as possible. Since 2022, we have become part of the prestigious multinational Legrand Group, providing us with further opportunities to innovate and improve our service to you.



Direct distributor for the Czech Republic, Slovakia, Hungary, Slovenia and Croatia.

[www.emos.eu](http://www.emos.eu)

### EMOS basic philosophy



**OPTIMAL PRICE/  
QUALITY RATIO  
OF PRODUCTS**

Each product is subject to strict quality control by a team of inspection staff directly at the manufacturer's site and our laboratory. We carry out nearly 1,100 tests a year, supervised by 25 specialists.



**24-HOUR  
STOCK  
AVAILABILITY**

We offer excellent stock availability of our products and fast delivery to our customers. A total storage area of over 16,000 m<sup>2</sup> allows us to keep more than 95% of the items in our range in stock and in sufficient inventory.



**SPEED AND  
EASE OF  
COMMUNICATION**

Customers communicate with us in the way that suits them best - through sales representatives, online B2B and B2C portals or by phone. 90 EMOS Group sales representatives visit an average of 650 customers per day

### About the multinational Legrand Group

Legrand is a global electrical and digital infrastructure specialist, offering high-value-added products and solutions that improve lives by transforming the spaces where people live, work, and meet. The Legrand Group employs more than 38,200 people in nearly 90 countries and works to improve buildings' electrical and digital infrastructures, helping to digitize them and reduce their carbon footprint. Legrand has solutions for all building types - residential buildings, data centers, other non-residential buildings, industrial spaces, and infrastructures. The Group's technological expertise, leadership position, the breadth and diversity of its offerings, its international presence, and the strength of its brands combine to make Legrand a global leader.

[#LegrandImprovingLives](https://www.legrandgroup.com)

[www.legrandgroup.com](http://www.legrandgroup.com)

[@legrand](https://twitter.com/legrand)



# EMOS dealership

## CZECH REPUBLIC

### Headquarters and logistics centre

EMOS spol. s r.o.  
Lipnická 2844  
750 02 Přerov

ID No.: 19014104  
tax ID No.: CZ19014104  
bank account number: 296149831/0100  
e-mail: emos@emos.cz

contact person: +420 581 261 111  
customer centre B2B: +420 581 261 270  
customer centre B2C: +420 581 261 233  
sales fax: +420 581 701 332

warehouse: +420 581 261 160 / 290 / 293  
complaints: +420 581 261 281  
GPS: 49.467587°N, 17.448671°E

### Office Prague

EMOS spol. s r.o.  
PB Park, Průmyslová 1306/7  
102 00 Praha 10 – Hostivař

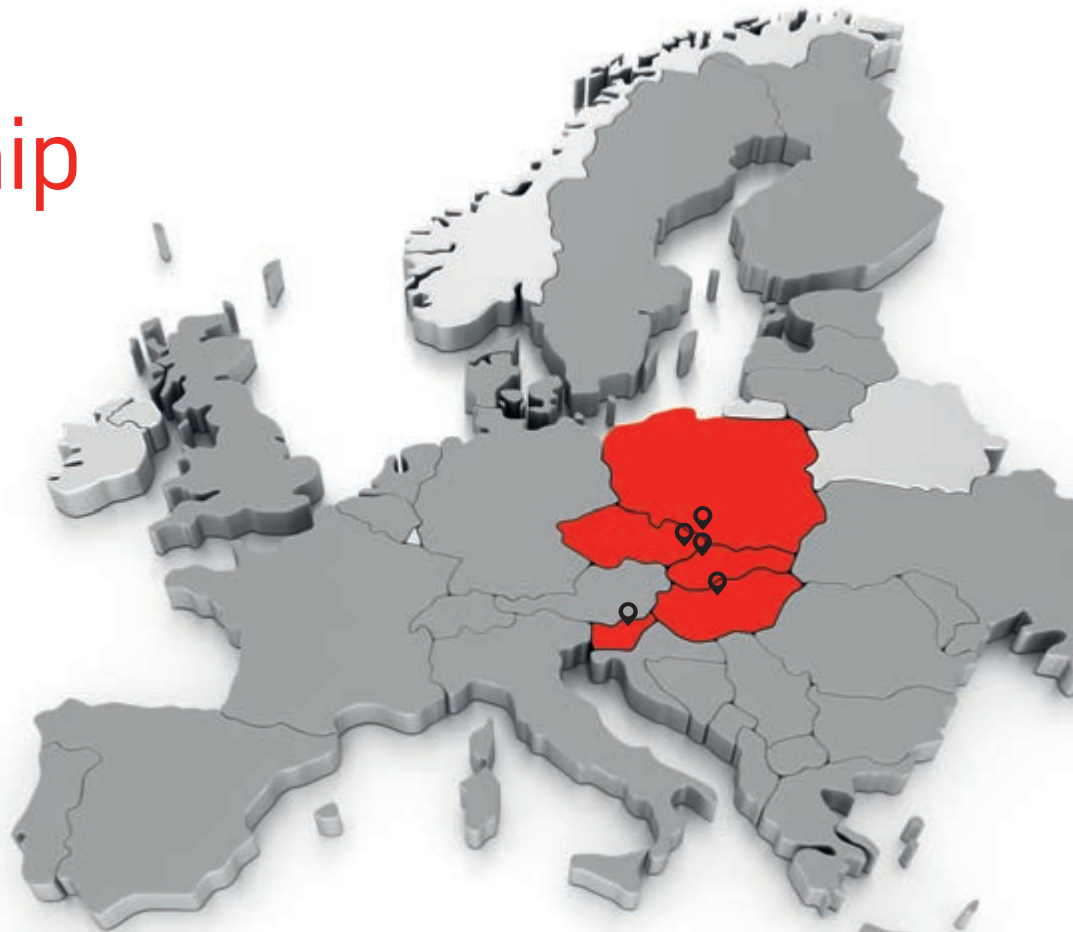

## SLOVAK REPUBLIC

EMOS SK s.r.o.  
Hlinická 409/22  
014 01 Bytča

ID No.: 36392961  
VAT No.: SK2020104834  
e-mail: info@emos.sk

Sales department: +421 41 50 916 14  
+421 902 96 69 96

Secretariat: +421 41 509 16 11

## POLAND

EMOS PL Sp. z o.o.  
ul. Gątczyńskiego 6  
43-300 Bielsko-Biała

tel.: +48 33 816 92 42  
e-mail: biuro@emos.pl

## SLOVENIA

EMOS SI, d.o.o.  
Rimska cesta 92  
3311 Šempeter v Savinjski dolini

tel.: +386 8 205 17 20  
e-mail: narocila@emos-si.si

### Croatia | Bosnia and Herzegovina | Serbia | Montenegro | North Macedonia

Sašo Marinšek  
Managing Director EMOS SI, d.o.o.  
GSM: +386 31 517 364  
e-mail: saso.marinsek@emos-si.si

## HUNGARY

EMOS HU Kft.  
Budaörs Office Park, A épület  
2040 Budaörs, Szabadság út 117.

tel.: +36 70 398 5891  
fax: +36 23 41 42 99  
e-mail: info@emos.hu

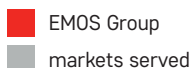

Albania | Belgium | Bosnia and Herzegovina | Bulgaria | Montenegro | Denmark | Estonia | Finland | France | Croatia | Italy | Latvia | Lithuania | Cyprus | Hungary | Moldova | Germany | Netherlands | Poland | Portugal | Austria | Romania | Greece | North Macedonia | Slovakia | Slovenia | Serbia | Spain | Sweden | Ukraine

## EXPORT

### Export departement + Germany | Austria | Sweden

Ladislav Novak  
Export Manager  
phone: +420 581 261 207  
GSM: +420 724 597 640  
e-mail: ladislav.novak@emos.cz

### Latvia | Estonia | Lithuania | Finland

Raman Sinevich  
Country Manager  
Baltic countries  
GSM: +371 295 901 79  
e-mail: raman.sinevich@legrand-ext.com

### Spain | Portugal | France | Greece | Netherlands | Italy | Denmark | Belgium

Jose Henriquez  
Export Sales Manager  
Phone: +420 581 261 127  
GSM: +420 602 551 726  
e-mail: jose-luis.henriquez@emos.cz

### Romania | Bulgaria | Republic of Moldova | Albania

Cseh Szabolcs  
Country Manager  
Baltic countries  
GSM: +40 745 536 783  
e-mail: szabolcs.cseh@legrand-ext.com



The Eurologistics Centre of EMOS Holding, with an area of over 16,000 m<sup>2</sup>, supports EMOS' strategy to offer its business partners excellent stock availability of products from its range.

# EMOS GoSmart

Smart living is even  
more accessible

Create your own smart home with EMOS GoSmart and other TUYA-compatible smart devices. Connect individual products, set up automation for their activities and control them remotely with a fully localized and intuitive mobile app.



## HOME SECURITY

- Indoor IP cameras
- Outdoor IP cameras
- Video door phones
- Video doorbells
- Sensors
- Access control systems



## MEASUREMENT AND CONTROL

- Thermostats
- Weather stations and Thermometers
- Regulating Valves
- Air Quality

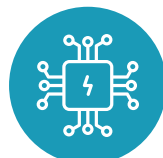

## WIRING AND CONTROL

- Scenic switches
- Smart hubs
- Extension cords
- Sockets
- Modules



## LUMINAIRES AND LIGHT SOURCES

- Bulbs
- Strips
- Luminaires
- Christmas lighting
- Floodlights
- Garden lighting
- Ambient lighting



## HOME AND GARDEN

- Scales
- Feeders
- Irrigation Systems





EMOS GoSmart

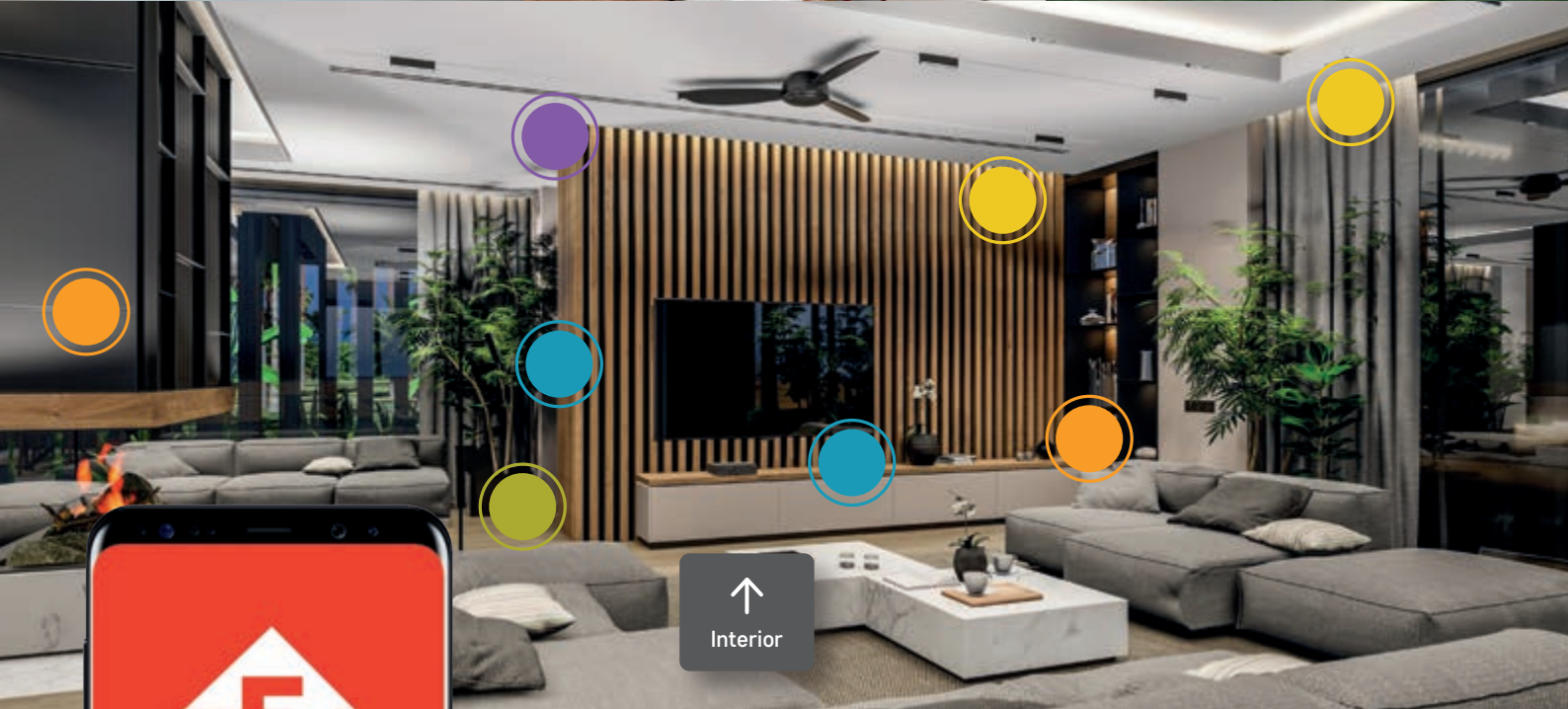

EMOS GoSmart is here to make your life more pleasant, safer, and comfortable.



[www.emosgosmart.eu](http://www.emosgosmart.eu)

# EMOS GoSmart products

## Optimal price/quality ratio

With the affordable prices and excellent quality of EMOS GoSmart products, the smart home system becomes accessible to everyone. You can easily create your smart home without complicated renovation and equipment installation.



### WIDE RANGE OF PRODUCTS

Dozens of EMOS GoSmart products are developed by the world's leading manufacturers.



### OPTIMAL PRICE AND QUALITY

EMOS GoSmart products are subject to quality control directly at the manufacturer's and in our laboratory.



### THE ONLY MOBILE APP

The EMOS GoSmart app allows you to control your device via your mobile phone from anywhere.



### TECHNICAL SUPPORT

We provide technical support and help to get EMOS GoSmart products up and running.



### COMPATIBILITY AND EXPANDABILITY

Expand your smart home with EMOS GoSmart products and thousands of other TUYA compatible products.



## Advanced technology

EMOS GoSmart products communicate via Wi-Fi network, Bluetooth, or ZigBee communication protocols. You can even use voice control thanks to their compatibility with Amazon Alexa and Google Assistant.



Works with  
Amazon Alexa  
Google Assistant



Powered by



## Data security and compatibility

### EMOS GoSmart priorities

The basis of the EMOS GoSmart system is the **global TUYA platform**. This platform meets the most demanding security requirements and, using encrypted communication, allows you to connect the devices in your smart home, keeping them compatible and easy to use.

Renowned brands that have chosen the **TUYA platform for their smart devices include HAMA, LIDL, LEDVANCE, PHILIPS, and many others.**

TUYA compatible products

Other compatible EMOS products



EMOS GoSmart products



# EMOS GoSmart app

## Full localization and ease of use

The EMOS GoSmart app makes it easy to control all your smart home devices via your **Android** or **iOS** mobile phone or tablet. The perfect localization allows you to communicate with the app in your native language.



Smart  
control  
of your  
home

Control  
multiple  
devices



Never  
miss  
a visit



Create and use  
smart  
scenarios



Connect  
from  
anywhere

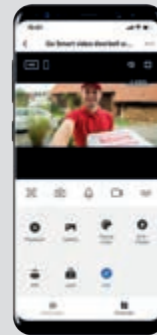

Share with  
your family  
with one tap



Without complicated settings, you can keep track of any activities in your home with the EMOS GoSmart app and control conveniently all your devices remotely.



### FULL LOCALIZATION

Full localization allows you to communicate with the app in your native language.



### EASY TO USE

You don't have to worry about complicated app controls. Anyone can handle it.



### SMART SCENARIOS

Have your products work together using the smart scenarios.



### DEVICE MANAGEMENT

All your smart home devices can be controlled from anywhere using the app.



### SMART NOTIFICATIONS

The app sends you notifications about any activity in your home.

EMOS GoSmart is here to make your life more pleasant, safer, and comfortable.

<b>GoSmart</b> .....	4	Headlights .....	78
Home Security .....	4	GP Xplor .....	78
Indoor IP cameras .....	4	GP Discovery .....	79
Outdoor IP cameras .....	5	EMOS .....	81
Video door phones .....	6	LED Metal Flashlights .....	81
Video doorbells .....	7	ULTIBRIGHT Flashlights .....	81
Entry code keypads .....	8	EMOS Flashlights .....	82
Sensors .....	8	EMOS .....	84
Luminaires and Light Sources .....	10	LED Plastic Flashlights .....	84
Bulbs .....	10	LED Headlights .....	86
Luminaires .....	12	LED Work Lights .....	89
Christmas Lighting .....	13	LED Rechargeable Work Lights .....	89
Wiring and Control .....	14	LED Work Lights .....	92
Scenic switches .....	14	LED Work Lights – 230 V .....	93
Zigbee gateways .....	15	EMOS .....	94
Sockets .....	16	LED Rechargeable flashlights EXPERT .....	94
Modules .....	17	LED Bike Lights .....	95
Measurement and Control .....	20	LED Night Lights .....	96
Thermostats .....	20	LED Battery Night Lights .....	96
Weather stations and Thermometers .....	21	LED 230 V Night Lights .....	97
Air quality .....	22	EMOS .....	99
Control valves .....	22	LED Flashlights display box .....	99
Household and Garden .....	23	LED Keychains display box .....	102
Bathroom Scales .....	23	Insect killer .....	103
<b>Batteries</b> .....	24	Spare parts .....	103
GP Batteries .....	24	<b>Lighting</b> .....	104
GP Consumer batteries .....	24	Light sources .....	104
GP Alkaline .....	24	LED bulbs .....	104
GP Ultra Plus .....	24	Filament .....	104
GP Ultra .....	26	Classic .....	115
GP Super .....	29	Basic .....	133
GP Carbon Zinc .....	33	GoSmart Bulbs .....	138
GP Greencell .....	33	Light sources .....	140
GP Supercell .....	36	Light bulbs for electrical appliances .....	140
GP Other batteries .....	37	ECO halogen .....	141
GP Lithium cylindrical .....	37	LED tubes, tubes .....	142
GP Lithium button .....	39	PROFI PLUS .....	142
GP Special alkaline .....	45	BASIC .....	144
GP Alkaline button .....	47	Luminaires .....	145
GP Silver oxide .....	49	Highbays .....	145
GP Zinc air .....	51	PROFI PLUS .....	145
GP Rechargeable .....	52	ASTER .....	145
GP ReCyko Pro .....	52	PROFI .....	148
GP ReCyko .....	53	CORUS .....	148
Raver Batteries .....	57	Highbays .....	149
Raver Lithium cylindrical .....	57	Accessories .....	149
Raver Alkaline .....	58	Dustproofs .....	150
Raver Ultra .....	58	PROFI PLUS .....	150
Raver Batteries .....	59	MISTY .....	150
Raver Rechargeable .....	59	PROFI .....	152
Raver Other batteries .....	60	FESTY .....	152
Raver Lithium button .....	60	ESSENTIAL .....	153
Batteries EMOS, lead acid battery .....	61	DUSTY .....	153
Lead acid batteries .....	61	Street Lights .....	154
<b>Battery chargers, powerbanks, USB chargers</b> .....	64	PROFI .....	154
Battery chargers .....	64	SOLIS .....	154
Charge 10 .....	64	Floodlights .....	155
GP Battery chargers .....	65	PROFI PLUS .....	155
EMOS Battery chargers .....	67	AVENO .....	155
Powerbanks .....	68	PROFI .....	158
GP Powerbanks .....	68	INOVO .....	158
EMOS Powerbanks .....	70	CLASSIC .....	161
USB chargers .....	71	ILJO .....	161
Universal adaptors .....	72	TAMBO .....	163
Car battery chargers, testers .....	73	ESSENTIAL .....	165
<b>Portable Lighting</b> .....	75	SIMPO .....	165
GP .....	75	Floodlights .....	167
Flashlights .....	75	Accessories .....	167
GP Discovery .....	75	Work Lights .....	168
GP Everyday .....	77	PROFI .....	168





CANNO	168	AMAL	226
CLASSIC	169	DIRAL	227
ILIO	169	DIRBI	228
HOBBOY SLIM	170	Cabinet Luminaires	229
ACCO	170	CLASSIC	229
Linear Luminaires	171	TIGO	229
PROFI PLUS	171	Luminaires	230
ORTO	171	Desk and Floor Lamps	230
LED Panels	173	Sensors	236
PROFI PLUS	173	Decorations	238
PROXO	173	Smart chains	238
PIXO	175	Chains GoSmart	238
LEXO	175	Decorations	240
TROXO	176	Party	240
VEXO	177	Lantern	241
EXCLUSIVE	178	LED candles	241
RIVI	178	<b>Weather stations, thermometers, scales, others</b>	<b>243</b>
PROFI	179	Weather stations	243
MAXXO	179	Weather stations	243
REXXO	180	Thermometers	246
ESSENTIAL	181	Thermometers	246
DAXXO	181	Thermometers GoSmart	249
LED Panels	182	Spare sensors	249
Accessories	182	Kitchen, hanging scales	251
Luminaires	183	Kitchen timers	253
Drivers	183	Personal scales	254
Surface Luminaires	184	Air quality GoSmart	255
EXCLUSIVE	184	Bathroom scales GoSmart	255
RIVI	184	<b>TV and audio accessories</b>	<b>256</b>
ALVI	185	Multimedia players, radios	256
ILVI	186	TV wall mounts	256
LIVI	186	Universal remote controllers OFA	258
ILVI GoSmart	187	<b>Power supply extension cords, cable reels, plugs, accessories</b>	<b>261</b>
PROFI	188	Power supply extension cords and sockets	261
NEXXO	188	FRENCH	261
TIVI	194	Single socket extension cords	261
DIONI	195	Two-cores PVC	261
CLASSIC	197	SCHUKO	262
TORI	197	MOES Extension cords	262
CORI	199	1-phase 16A with rubber insulation	262
DORI	200	1-phase 16A with PVC insulation	263
ZURI	201	Single socket extension cords	269
QARI	202	1-phase 16A with rubber insulation	269
RORI	203	1-phase 16A with PVC weatherproof insulation	270
ESSENTIAL	204	1-phase 16A with PVC insulation	271
RUBIC	204	SCHUKO	272
FIONI	205	MOES	272
FLORI	206	Surge protectors	273
Surface Luminaires	208	Surge protectors EMOS SCHUKO	273
Others	208	Assembled cords	274
Pendant Luminaires	209	3-phase rubber	274
CLASSIC	209	Cable reels	275
Recessed Luminaires	210	SCHUKO	275
EXCLUSIVE	210	3-phase rubber	275
SIMMI	210	1-phase weatherproof PVC	276
PROFI	211	1-phase rubber	277
NEXXO	211	1-phase PVC	279
VIXXO	217	Sockets, plugs, adaptors, timers, others	281
GERI	219	Holders	281
ESSENTIAL	220	Plugs, sockets	282
RUBIC	220	Adaptors	283
Emergency Luminaires	222	Travel adaptors	284
PROFI	222	Timers	284
CESSI	222	Energy consumption meters	286
NESSI	223	GoSmart sockets	286
ORSU	224	Industrial plugs, 380 V sockets	287
Emergency Luminaires	225	Flexo, assembled cords	289
Emergency conversion kit	225	Rubber	289
Orientation Luminaires	226	Two-cores	289
CLASSIC	226	Three-cores	290

PVC .....	292	Installation material .....	379
Two-cores .....	292	Terminal blocks .....	379
Three-cores .....	293	Installation material others .....	380
<b>Cables .....</b>	<b>296</b>	Transformer solders, copper, rosin .....	381
Data cables UTP, FTP .....	296	<b>Tapes .....</b>	<b>382</b>
Data cables CAT 5E .....	296	Electroinsulating PVC tapes .....	382
Data cables CAT 6 .....	299	Other tapes .....	386
Connectors, patch accessories .....	300		
Connection patch cables, accessories .....	300		
Connectors IEC, F, reductions .....	303		
Twin-shielded cables CYH .....	306		
Coaxial cables .....	311		
Coaxial cables 50 Ohm .....	311		
Coaxial cables 75 Ohm .....	311		
Connection AV cables .....	317		
AV cables blister .....	317		
AV cables polybag .....	318		
AV cables hanger .....	318		
AV cables paper blister .....	319		
Smartphone cables .....	322		
Solid, flexible cables .....	326		
Solid cables CYKY-J .....	326		
Flexible cables PVC CYSY .....	326		
Solar cables .....	327		
<b>HF signal receiving components, antennas, small electronic, accessories ...</b>	<b>328</b>		
Antennas .....	328		
CITY .....	328		
VILLAGE .....	330		
PROFI .....	331		
TV signal receivers .....	333		
TV signal receivers .....	333		
Accessories .....	333		
Wall sockets .....	334		
Accessories .....	336		
Combiners, splitters .....	336		
Amplifiers, preamplifiers, LTE filters .....	337		
Power supply units for antennas .....	339		
Holders for satellite, terrestrial antennas .....	340		
ZigBee GoSmart .....	341		
<b>Videophones, doorbells .....</b>	<b>342</b>		
Home videophones, sets .....	342		
Home videophones .....	342		
Videophones and video doorbells GoSmart .....	345		
Accessories for videophones .....	346		
Cameras, Surveillance .....	347		
GoSmart Cameras .....	347		
Doorbells .....	349		
Wireless doorbells .....	349		
Spare push buttons .....	353		
Wired doorbells .....	355		
Sensors GoSmart .....	356		
<b>Multimeters, testers .....</b>	<b>357</b>		
Multimeters, measuring cables .....	357		
Testers .....	360		
Measuring instruments .....	362		
<b>Thermostats, CO and smoke alarms .....</b>	<b>363</b>		
Thermostats .....	363		
Thermostats EMOS .....	363		
Thermostats GoSmart .....	367		
CO and smoke alarms .....	368		
Valve closer GoSmart .....	369		
Detectors GoSmart .....	370		
<b>Installation material, tapes .....</b>	<b>371</b>		
Installation material .....	371		
Sockets, switches .....	371		
EMOS .....	371		
IP20 .....	371		
IP54/IP44 .....	374		
Scene switches GoSmart .....	375		
Modules GoSmart .....	377		



# GoSmart



## Home Security

### Indoor IP cameras



- For keeping people safe and protecting the interiors of homes
- Alerts of unusual activity sent to mobile devices
- Continuous tracking of moving person for better recording quality
- Two-way voice communication
- Automatic video and audio recording when motion is detected
- Connection to home network via WIFI protocol
- Compatibility with EMOS GoSmart products and TUYA devices
- Voice control with Google Assistant and Amazon Alexa



- automatic image saving
- setting the detection area
- night vision
- camera viewing angle: 100°
- IP rating: IP20
- camera resolution: 1 920 × 1 080
- motion detection
- sound detection
- compatibility: EMOS GoSmart, TUYA, LIDL, Smartlife
- protocol: Wi-Fi
- transmission frequency: 2.4 GHz WIFI
- voice communication: two-way
- motion tracking
- motorised rotation
- motion detection angle: 100°
- motion detection range: 10 meters



**H4051** 1/-/-12  
30 24 040 510 IP-100 CUBE

- automatic image saving
- setting the detection area
- night vision
- camera viewing angle: 100°
- IP rating: IP20
- camera resolution: 2 304 × 1 296
- motion detection
- sound detection
- compatibility: EMOS GoSmart, TUYA, LIDL, Smartlife
- protocol: Wi-Fi
- transmission frequency: 2.4 GHz WIFI
- voice communication: two-way
- motion tracking
- motorised rotation
- motion detection angle: 100°
- motion detection range: 10 meters
- human body recognition



**H4052** 1/-/-6  
30 24 040 520 IP-500 GUARD



www.emos.eu

Order Code  
Item Number

Packaging  
Type

- automatic image saving
- setting the detection area
- night vision
- camera viewing angle: 100°
- IP rating: IP20
- camera resolution: 2 304 × 1 296
- motion detection
- sound detection
- compatibility: EMOS GoSmart, TUYA, LIDL, Smartlife

- protocol: Wi-Fi
- transmission frequency: 2.4 GHz WIFI
- voice communication: two-way
- motion tracking
- motorised rotation
- motion detection angle: 100°
- motion detection range: 10 meters



**H4061** 1/-/-12  
30 24 040 610 IP-110 CUBEV2

## Outdoor IP cameras



- Surveillance of exteriors of commercial and private buildings
- Alerts of unusual activity sent to mobile devices
- High weather resistance - IP65
- Two-way voice communication to deter intruders
- Automatic video and audio recording when motion is detected
- Connection to home network via WIFI protocol
- Compatible with EMOS GoSmart products and TUYA devices
- Voice control with Google Assistant and Amazon Alexa

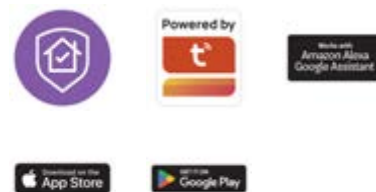

- automatic image saving
- night vision
- camera viewing angle: 110°
- IP rating: IP55
- camera resolution: 1 920 × 1 080
- motion detection
- compatibility: EMOS GoSmart, TUYA, LIDL, Smartlife
- protocol: Wi-Fi
- transmission frequency: 2.4 GHz WIFI

- voice communication: two-way
- motion detection angle: 120°
- motion detection range: 10 meters
- human body recognition



**H4056** 1/-/-5  
30 24 040 560 IP-600 EYE

- automatic image saving
- setting the detection area
- night vision
- camera viewing angle: 110°
- IP rating: IP65
- camera resolution: 2 616 × 1 958
- motion detection
- sound detection
- compatibility: EMOS GoSmart, TUYA, LIDL, Smartlife

- protocol: Wi-Fi
- transmission frequency: 2.4 GHz WIFI
- voice communication: two-way
- motion tracking
- motorised rotation
- motion detection angle: 110°
- motion detection range: 10 meters
- human body recognition



**H4057** 1/-/-4  
30 24 040 570 IP-800 WASP

- automatic image saving
- setting the detection area
- night vision: yes, 4× IR LED + white LED
- camera viewing angle: 105°
- IP rating: IP65
- camera resolution: 2 048 × 1 536
- motion detection
- compatibility: EMOS GoSmart, TUYA, LIDL, Smartlife
- protocol: 4G, LTE

- transmission frequency: LTE
- voice communication: two-way
- motorised rotation
- motion detection angle: 120°
- motion detection range: 10 meters
- human body recognition



**H4058** 1/-/-4  
30 24 040 580 IP-6000 OWL





www.emos.eu

Order Code  
Item Number

Packaging  
Type

- automatic image saving
- setting the detection area
- night vision: yes, 9× IR LED 850 nm
- camera viewing angle: 130°
- IP rating: IP65
- camera resolution: 2 592 × 1 944
- motion detection
- compatibility: EMOS GoSmart, TUYA, LIDL, Smartlife
- protocol: Wi-Fi

- transmission frequency: 2.4 GHz WIFI
- voice communication: two-way
- motion detection angle: 120°
- motion detection range: 9 metres
- human body recognition



**H4063** 1/-/-14  
30 24 040 630 IP-210 SNAPV2

- automatic image saving
- setting the detection area
- night vision: yes, 4× IR LED + white LED
- camera viewing angle: 130°
- IP rating: IP65
- camera resolution: 2 304 × 1 296
- motion detection
- compatibility: EMOS GoSmart, TUYA, LIDL, Smartlife
- protocol: Wi-Fi

- transmission frequency: 2.4 GHz WIFI
- voice communication: two-way
- motion tracking
- motorised rotation
- motion detection angle: 120°
- motion detection range: 10 meters



**H4064** 1/-/-4  
30 24 040 640 IP-310 TORCHV2  
WHITE

- automatic image saving
- setting the detection area
- night vision: yes, 4× IR LED + white LED
- camera viewing angle: 130°
- IP rating: IP65
- camera resolution: 2 304 × 1 296
- motion detection
- compatibility: EMOS GoSmart, TUYA, LIDL, Smartlife
- protocol: Wi-Fi

- transmission frequency: 2.4 GHz WIFI
- voice communication: two-way
- motion tracking
- motorised rotation
- motion detection angle: 120°
- motion detection range: 10 meters



**H4065** 1/-/-4  
30 24 040 650 IP-310 TORCHV2  
BLACK

## Video door phones



- Perfect access control for commercial and private properties
- Unusual activity alerts sent to mobile devices
- Two-way communication with the visitor without opening the door
- Automatic video and audio recording when motion is detected
- Night vision for perfect images in all lighting conditions
- With accessories, the ability to secure multiple homes at once
- Compatible with EMOS GoSmart products and TUYA devices

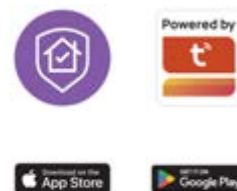

- product: doorphone set with WiFi
- screen size: 7"
- possibility to record
- lock control
- gate control
- intercom
- power supply for the screen: 12 V DC (included)
- optional connection of CCTV camera
- monitor size: 175 × 118 × 25 mm

- dimensions of the camera unit: 142 × 44 × 21 mm
- camera viewing angle: 160°
- packaging: 1 pc, box
- supported OS: Android, iOS
- compatibility: EMOS GoSmart, TUYA, LIDL, Smartlife,
- protocol: Wi-fi
- connectivity: 2.4 GHz WIFI
- voice communication: two-way



**H4020** 1/-/-4  
30 10 040 200 IP-750A



www.emos.eu

Order Code  
Item Number

Packaging  
Type

- product: video phone
- screen size: 7
- lock and gate control
- intercom
- power supply for the monitor: 12 V DC (included)
- recommended camera unit: H3016, H3017, H3018,
- monitor size: 145 × 205 × 12 mm
- packaging: 1 pc, box



**H4021**  
30 10 040 210

1/-/-6  
IP-750B

## Video doorbells



- Perfect access control for commercial and private properties
- Unusual activity alerts sent to mobile devices
- Two-way communication with the visitor without opening the door
- Automatic video and audio recording when motion is detected
- Night vision for perfect images in all lighting conditions
- Different power supply options for rooms w/o cable distribution
- Compatibility with EMOS GoSmart products and TUYA devices
- Voice control with Google Assistant and Amazon Alexa



- lock control
- additional indoor bell
- camera viewing angle: 110°
- camera resolution: 1 920 × 1 080
- motion detection
- IR CUT
- siren
- supported OS: Android, iOS
- compatibility: EMOS GoSmart, TUYA, LIDL, Smartlife

- protocol: Wi-Fi
- transmission frequency: 2.4 GHz WIFI
- SD card storage
- cloud storage
- anti-theft protection
- control by voice assistants
- voice communication: two-way
- notifications to the mobile app
- WebRTC function



**H4030**  
30 10 040 300

1/-/-8  
IP-09D DC

- lock control
- additional indoor bell
- camera viewing angle: 110°
- camera resolution: 1 920 × 1 080
- motion detection
- IR CUT
- siren
- supported OS: Android, iOS
- compatibility: EMOS GoSmart, TUYA, LIDL, Smartlife

- protocol: Wi-Fi
- transmission frequency: 2.4 GHz WIFI
- SD card storage
- cloud storage
- anti-theft protection
- control by voice assistants
- voice communication: two-way
- notifications to the mobile app
- WebRTC function



**H4031**  
30 10 040 310

1/-/-12  
IP-09C

- additional indoor bell
- camera viewing angle: 130°
- camera resolution: 1 920 × 1 080
- motion detection
- IR CUT
- supported OS: Android, iOS
- compatibility: EMOS GoSmart, TUYA, LIDL, Smartlife
- protocol: Wi-Fi
- transmission frequency: 2.4 GHz WIFI

- SD card storage
- cloud storage
- anti-theft protection
- control by voice assistants
- voice communication: two-way
- notifications to the mobile app
- WebRTC function



**H4032**  
30 10 040 320

1/-/-10  
IP-15S

## Entry code keypads



- High quality and robust keyboard finish that prevents intentional damage and ensures long life.
- Remote unlocking via APP
- Input logging function for easy attendance management
- Individual member management (each member can have their own unique code or RFID chip)
- Compatibility with EMOS GoSmart products and TUYA devices
- Voice control with Google Assistant and Amazon Alexa

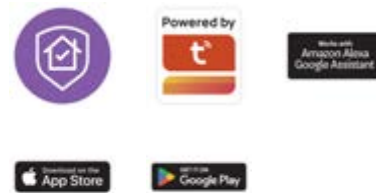

- product: keyboard RFID, TUYA
- number of switching relays: 1
- number of codes: up to 1 000
- power source: 12 V AC/DC (not included)
- dimensions: 23 × 78 × 115 mm
- packaging: 1 pc, box
- frequency: 125 kHz
- supported OS: Android, iOS
- compatibility: EMOS GoSmart, TUYA, LIDL, Smartlife
- protocol: Wi-Fi
- transmission frequency: 2.4 GHz Wi-Fi
- cloud storage



**H5023**      1/-/-18  
 30 69 050 230      IP-006AX

## Sensors



- Sensors to secure your home
- Immediate notification of an unusual situation via the app
- Optical and audible signalling
- Sensors that detect motion, water/gas leaks, fire, etc.
- Connect to your home network via Wi-Fi/ZigBee protocol
- Compatibility with EMOS GoSmart products and TUYA devices
- Voice control with Google Assistant and Amazon Alexa

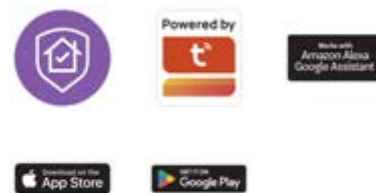

- detection type: smoke detector
- type of installation: possible to mount on the wall
- type of signaling: optical and audible
- transmission frequency: 2.4 GHz Wi-Fi
- operating temperature: 0 °C to 40 °C
- operating humidity: 0-93 %
- lifetime: 10 years
- IP rating: IP20
- power source: 2× 1.5 V AA, included
- packaging: 1 pc, small box
- supported OS: Android, iOS
- compatibility: EMOS GoSmart, TUYA, LIDL, Smartlife,
- protocol: Wi-Fi
- notifications to the mobile app
- application languages: EN, CZ, SK, PL, DE, HU, SI, FR,



**P56500S**      1/-/-16  
 21 04 103 000      TSS380C-HW

- detection type: water leak detector
- type of installation: free-standing
- type of signaling: optical and audible
- memory of alarms
- transmission frequency: Zigbee 3.0
- operating temperature: 5 °C to 38 °C
- operating humidity: ≤80 % without condensation
- lifetime: 10 years
- IP rating: IP65
- power source: 1× 3 V CR2, included
- packaging: 1 pc, small box
- supported OS: Android, iOS
- compatibility: EMOS GoSmart, TUYA, LIDL, Smartlife,
- protocol: Zigbee 3.0
- notifications to the mobile app
- application languages: EN, CZ, SK, PL, DE, HU, SI, FR,



**P56000S**      1/-/-48  
 21 04 104 000      P56000S





www.emos.eu

Order Code  
Item Number

Packaging  
Type

- detection type: detector CO
- type of installation: possible to mount on the wall or ceiling
- type of signaling: optical and audible
- memory of alarms
- transmission frequency: 2.4 GHz Wi-Fi
- operating temperature: -10 °C to 40 °C
- operating humidity: 15–93 %
- lifetime: 10 years
- IP rating: IP30
- power source: 2× 1.5 V AA, included
- packaging: 1 pc, small box
- supported OS: Android, iOS
- compatibility: EMOS GoSmart, TUYA, LIDL, Smartlife,
- protocol: Wi-Fi
- notifications to the mobile app
- application languages: EN, CZ, SK, PL, DE, HU, SI, FR,



**P56400S** 1/-/-/20  
21 04 105 000 TCS0101W

- product: motion sensor
- detection angle: 90°
- detection distance: 8 m
- IP rating: IP20
- sensor type: PIR
- power source: 1× CR123A (3 V)
- packaging: 1 pc, small box
- supported OS: Android, iOS
- compatibility: EMOS GoSmart, TUYA, LIDL, Smartlife
- protocol: Zigbee 3.0
- transmission frequency: 2.4 GHz (2 405–2 480 MHz)
- notifications to the mobile app
- application languages: EN, CZ, SK, PL, DE, HU, SI, FR,



**H5020** 1/-/-/40  
30 69 052 010 IP-2210Z

- product: door/window sensor
- IP rating: IP20
- sensor type: magnetic
- power source: 1× CR2032 (3 V)
- packaging: 1 pc, small box
- supported OS: Android, iOS
- compatibility: EMOS GoSmart, TUYA, LIDL, Smartlife
- protocol: Zigbee 3.0
- transmission frequency: 2.4 GHz (2 405–2 480 MHz)
- notifications to the mobile app
- application languages: EN, CZ, SK, PL, DE, HU, SI, FR,



**H5021** 1/-/-/100  
30 69 052 020 IP-2211Z

# Luminaires and Light Sources

## Bulbs



- Remote light on/off
- Brightness, light colour and chromaticity temperature control
- Energy saving with automatic switch-off and dimming options
- Set unique lighting scenes for different activities
- Easy to install and create automations
- Connection to the home network via WIFI protocol
- Compatibility with EMOS GoSmart products and TUYA devices
- Voice control with Google Assistant and Amazon Alexa



- replacement of incandescent bulb: 60 W
- dimmable
- shape: A60
- luminous flux: 806 lm
- color temperature: 2 700-6 500 K
- power: 9 W
- luminous efficacy: 90 lm/W
- energy efficiency class: F
- beam angle: 200°

- color rendering index (CRI): Ra >80
- voltage: 230 V~/50 Hz
- dimensions: 60 × 60 × 120 mm
- packaging: 1 pc, small box
- supported OS: Android, iOS
- compatibility: EMOS GoSmart, TUYA, LIDL, Smartlife
- protocol: Wi-Fi
- control by voice assistants
- notifications to the mobile app



**QZW514R** 1/-/10/40  
15 20 503 500 QZW514R

- replacement of incandescent bulb: 75 W
- dimmable
- shape: A60
- luminous flux: 1 050 lm
- color temperature: 2 700-6 500 K
- power: 11 W
- luminous efficacy: 95 lm/W
- energy efficiency class: F
- beam angle: 200°

- color rendering index (CRI): Ra >80
- voltage: 230 V~/50 Hz
- dimensions: 60 × 60 × 125 mm
- packaging: 1 pc, small box
- supported OS: Android, iOS
- compatibility: EMOS GoSmart, TUYA, LIDL, Smartlife
- protocol: Wi-Fi
- control by voice assistants
- notifications to the mobile app

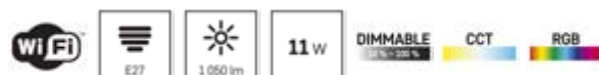

**QZW515R** 1/-/10/40  
15 20 503 501 QZW515R

- replacement of incandescent bulb: 94 W
- dimmable
- shape: A65
- luminous flux: 1 400 lm
- color temperature: 2 700-6 500 K
- power: 14 W
- luminous efficacy: 100 lm/W
- energy efficiency class: F
- beam angle: 200°

- color rendering index (CRI): Ra >80
- voltage: 230 V~/50 Hz
- dimensions: 65 × 65 × 134 mm
- packaging: 1 pc, small box
- supported OS: Android, iOS
- compatibility: EMOS GoSmart, TUYA, LIDL, Smartlife
- protocol: Wi-Fi
- control by voice assistants
- notifications to the mobile app



**QZW516R** 1/-/4/24  
15 20 503 502 QZW516R



www.emos.eu

Order Code  
Item Number

Packaging  
Type

- replacement of incandescent bulb: 40 W
- dimmable
- shape: Candle
- luminous flux: 470 lm
- color temperature: 2 700–6 500 K
- power: 4.8 W
- luminous efficacy: 98 lm/W
- energy efficiency class: F
- beam angle: 180°

- color rendering index (CRI): Ra >80
- voltage: 230 V~/50 Hz
- dimensions: 37 × 37 × 110 mm
- packaging: 1 pc, small box
- supported OS: Android, iOS
- compatibility: EMOS GoSmart, TUYA, LIDL, Smartlife
- protocol: Wi-Fi
- control by voice assistants
- notifications to the mobile app



**ZQW322R** 1/-/10/60  
15 25 501 500 ZQW322R

- replacement of incandescent bulb: 35 W
- dimmable
- shape: MR16
- luminous flux: 400 lm
- color temperature: 2 700–6 500 K
- power: 4.8 W
- luminous efficacy: 83 lm/W
- energy efficiency class: G
- beam angle: 120°

- color rendering index (CRI): Ra >80
- voltage: 230 V~/50 Hz
- dimensions: 50 × 50 × 56.5 mm
- packaging: 1 pc, small box
- supported OS: Android, iOS
- compatibility: EMOS GoSmart, TUYA, LIDL, Smartlife
- protocol: Wi-Fi
- control by voice assistants
- notifications to the mobile app



**ZQW832R** 1/-/4/72  
15 25 500 500 ZQW832R

- replacement of incandescent bulb: 60 W
- dimmable
- shape: A60
- luminous flux: 806 lm
- color temperature: 2 700–6 500 K
- power: 9 W
- luminous efficacy: 90 lm/W
- energy efficiency class: F
- beam angle: 200°

- color rendering index (CRI): Ra >80
- voltage: 230 V~/50 Hz
- dimensions: 60 × 60 × 120 mm
- packaging: 1 pc, small box
- supported OS: Android, iOS
- compatibility: EMOS GoSmart, TUYA, LIDL, Smartlife
- protocol: Zigbee 3.0
- control by voice assistants
- notifications to the mobile app



**ZQZ514R** 1/-/10/40  
15 25 753 500 ZQZ514R

- replacement of incandescent bulb: 75 W
- dimmable
- shape: A60
- luminous flux: 1 050 lm
- color temperature: 2 700–6 500 K
- power: 11 W
- luminous efficacy: 95 lm/W
- energy efficiency class: F
- beam angle: 200°

- color rendering index (CRI): Ra >80
- voltage: 230 V~/50 Hz
- dimensions: 60 × 60 × 125 mm
- packaging: 1 pc, small box
- supported OS: Android, iOS
- compatibility: EMOS GoSmart, TUYA, LIDL, Smartlife
- protocol: Zigbee 3.0
- control by voice assistants
- notifications to the mobile app

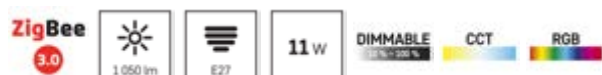

**ZQZ515R** 1/-/10/40  
15 25 753 501 ZQZ515R

- replacement of incandescent bulb: 94 W
- dimmable
- shape: A65
- luminous flux: 1 400 lm
- color temperature: 2 700–6 500 K
- power: 14 W
- luminous efficacy: 100 lm/W
- energy efficiency class: F
- beam angle: 200°

- color rendering index (CRI): Ra >80
- voltage: 230 V~/50 Hz
- dimensions: 65 × 65 × 134 mm
- packaging: 1 pc, small box
- supported OS: Android, iOS
- compatibility: EMOS GoSmart, TUYA, LIDL, Smartlife
- protocol: Zigbee 3.0
- control by voice assistants
- notifications to the mobile app



**ZQZ516R** 1/-/10/40  
15 25 753 502 ZQZ516R





www.emos.eu

Order Code  
Item Number

Packaging  
Type

- replacement of incandescent bulb: 40 W
- dimmable
- shape: Candle
- luminous flux: 470 lm
- color temperature: 2 700–6 500 K
- power: 4.8 W
- luminous efficacy: 98 lm/W
- energy efficiency class: F
- beam angle: 180°
- color rendering index (CRI): Ra >80
- voltage: 230 V~/50 Hz
- dimensions: 37 × 37 × 110 mm
- packaging: 1 pc, small box
- supported OS: Android, iOS
- compatibility: EMOS GoSmart, TUYA, LIDL, Smartlife
- protocol: Zigbee 3.0
- control by voice assistants
- notifications to the mobile app



**ZQZ322R** 1/-/10/60  
15 25 751 500 ZQZ322R

- replacement of incandescent bulb: 35 W
- dimmable
- shape: MR16
- luminous flux: 400 lm
- color temperature: 2 700–6 500 K
- power: 4.8 W
- luminous efficacy: 83 lm/W
- energy efficiency class: G
- beam angle: 120°
- color rendering index (CRI): Ra >80
- voltage: 230 V~/50 Hz
- dimensions: 50 × 50 × 56.5 mm
- packaging: 1 pc, small box
- supported OS: Android, iOS
- compatibility: EMOS GoSmart, TUYA, LIDL, Smartlife
- protocol: Zigbee 3.0
- control by voice assistants
- notifications to the mobile app



**ZQZ832R** 1/-/4/72  
15 25 750 500 ZQZ832R

## Luminaires



- Control via remote control or mobile app
- Adjustment of light intensity and colour
- Timer and night light function
- Connection to the home network via WIFI protocol
- Compatibility with EMOS GoSmart products and TUYA devices
- Voice control with Google Assistant and Amazon Alexa



- power: 30 W
- replacement of incandescent bulb: 110 W
- luminous flux: 1 800 lm
- color temperature: 2 700–6 500 K
- body material: steel plate
- color rendering index (CRI): Ra > 80
- beam angle: 115°
- type of mounting: surface
- dimensions: 400 × 70 mm in diameter
- dimming function
- body colour: white
- line: GoSmart
- warranty period: 3 years
- supported OS: Android, iOS
- compatibility: EMOS GoSmart, TUYA, LIDL, Smartlife
- protocol: Wi-Fi
- transmission frequency: 2.4 GHz Wi-Fi
- control by voice assistants



**ZM5191** 1/-/-/5  
15 39 087 300 ZM5191

- power: 45 W
- replacement of incandescent bulb: 160 W
- luminous flux: 2 700 lm
- color temperature: 2 700–6 500 K
- body material: steel plate
- color rendering index (CRI): Ra > 80
- beam angle: 115°
- type of mounting: surface
- dimensions: 500 × 70 mm in diameter
- dimming function
- body colour: white
- line: GoSmart
- warranty period: 3 years
- supported OS: Android, iOS
- compatibility: EMOS GoSmart, TUYA, LIDL, Smartlife
- protocol: Wi-Fi
- transmission frequency: 2.4 GHz Wi-Fi
- control by voice assistants



**ZM5192** 1/-/-/5  
15 39 087 400 ZM5192

# Christmas Lighting



- 64 lighting modes for a festive atmosphere
- Timer function for scheduled on/off
- Music synchronization for rhythmic blinking
- Various lengths 8–24 m, suitable for both indoor and outdoor use
- Connection to the home network via WIFI protocol
- Compatibility with EMOS GoSmart products and TUYA devices
- Voice control with Google Assistant and Amazon Alexa



- product: chain
- light color: RGB
- dimensions: 8 m
- area of use: both outdoor and indoor
- timer
- remote control: no
- number of LED: 80
- supply line length: 5 m
- power: 8.4 W

- IP rating: IP44
- lifetime: 10 000 hours
- supported OS: Android, iOS
- compatibility: EMOS GoSmart, TUYA, LIDL, Smartlife,
- protocol: Wi-Fi
- transmission frequency: 2,4 GHz Wi-Fi
- control by voice assistants
- notifications to the mobile app
- application languages: EN, CZ, SK, PL, DE, HU, SI, FR,



**D4ZR01** 1/-/-/30  
15 50 044 028 D4ZR01

- product: chain
- light color: RGB
- dimensions: 12 m
- area of use: both outdoor and indoor
- timer
- remote control: no
- number of LED: 120
- supply line length: 5 m
- power: 8.4 W

- IP rating: IP44
- lifetime: 10 000 hours
- supported OS: Android, iOS
- compatibility: EMOS GoSmart, TUYA, LIDL, Smartlife,
- protocol: Wi-Fi
- transmission frequency: 2,4 GHz Wi-Fi
- control by voice assistants
- notifications to the mobile app
- application languages: EN, CZ, SK, PL, DE, HU, SI, FR,



**D4ZR02** 1/-/-/25  
15 50 044 029 D4ZR02

- product: chain
- light color: RGB
- dimensions: 18 m
- area of use: both outdoor and indoor
- timer
- remote control: no
- number of LED: 180
- supply line length: 5 m
- power: 8.4 W

- IP rating: IP44
- lifetime: 10 000 hours
- supported OS: Android, iOS
- compatibility: EMOS GoSmart, TUYA, LIDL, Smartlife,
- protocol: Wi-Fi
- transmission frequency: 2,4 GHz Wi-Fi
- control by voice assistants
- notifications to the mobile app
- application languages: EN, CZ, SK, PL, DE, HU, SI, FR,



**D4ZR03** 1/-/-/20  
15 50 044 030 D4ZR03

- product: chain
- light color: RGB
- dimensions: 24 m
- area of use: both outdoor and indoor
- timer
- remote control: no
- number of LED: 240
- supply line length: 5 m
- power: 8.4 W

- IP rating: IP44
- lifetime: 10 000 hours
- supported OS: Android, iOS
- compatibility: EMOS GoSmart, TUYA, LIDL, Smartlife,
- protocol: Wi-Fi
- transmission frequency: 2,4 GHz Wi-Fi
- control by voice assistants
- notifications to the mobile app
- application languages: EN, CZ, SK, PL, DE, HU, SI, FR,



**D4ZR04** 1/-/-/16  
15 50 044 031 D4ZR04

# Wiring and Control

## Scenic switches



- Control multiple electrical devices or lights at once
- Define trigger events for individual buttons
- Long power supply battery life - up to 2 years
- Installation without pulling electrical cables
- Three-position buttons - press, double press, long press
- Communication via Zigbee protocol
- Compatible with EMOS GoSmart products and TUYA devices
- Voice control with Google Assistant and Amazon Alexa

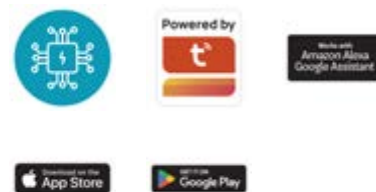

- product: IP Smart Scene Switcher
- connectivity: ZigBee 2.4 GHz
- compatibility: EMOS GoSmart, TUYA, LIDL, Smartlife
- protocol: Zigbee 3.0
- pairing: automatic, manual
- use: automation
- number of control buttons: 1
- power supply: CR 2430 3 V
- supported OS: Android, iOS



8 592920 121221 **H5011** 1/-/-/60  
30 69 050 110 IP-2001ZW

- product: IP Smart Scene Switcher
- connectivity: ZigBee 2.4 GHz
- compatibility: EMOS GoSmart, TUYA, LIDL, Smartlife
- protocol: Zigbee 3.0
- pairing: automatic, manual
- use: automation
- number of control buttons: 2
- power supply: CR 2430 3 V
- supported OS: Android, iOS



8 592920 121474 **H5012** 1/-/-/60  
30 69 050 120 IP-2002ZW

- product: IP Smart Scene Switcher
- connectivity: ZigBee 2.4 GHz
- compatibility: EMOS GoSmart, TUYA, LIDL, Smartlife
- protocol: Zigbee 3.0
- pairing: automatic, manual
- use: automation
- number of control buttons: 4
- power supply: CR 2430 3 V
- supported OS: Android, iOS



8 592920 121498 **H5013** 1/-/-/60  
30 69 050 130 IP-2004ZW





- product: IP Smart Scene Switcher
- connectivity: ZigBee 2.4 GHz
- compatibility: EMOS GoSmart, TUYA, LIDL, Smartlife
- protocol: Zigbee 3.0
- pairing: automatic, manual
- use: automation
- number of control buttons: 1
- power supply: CR 2430 3 V
- supported OS: Android, iOS



**H5014** 1/-/-/60  
30 69 050 140 IP-2001ZB

- product: IP Smart Scene Switcher
- connectivity: ZigBee 2.4 GHz
- compatibility: EMOS GoSmart, TUYA, LIDL, Smartlife
- protocol: Zigbee 3.0
- pairing: automatic, manual
- use: automation
- number of control buttons: 2
- power supply: CR 2430 3 V
- supported OS: Android, iOS



**H5015** 1/-/-/60  
30 69 050 150 IP-2002ZB

- product: IP Smart Scene Switcher
- connectivity: ZigBee 2.4 GHz
- compatibility: EMOS GoSmart, TUYA, LIDL, Smartlife
- protocol: Zigbee 3.0
- pairing: automatic, manual
- use: automation
- number of control buttons: 4
- power supply: CR 2430 3 V
- supported OS: Android, iOS



**H5016** 1/-/-/60  
30 69 050 160 IP-2004ZB

## Zigbee gateways

- To expand the smart home with additional sensors and products
- Allows automation settings for added sensors and products
- Communication protocols Wi-Fi/Zigbee 3.0/BLE/SigMesh
- Compatibility with EMOS GoSmart products and TUYA devices



- product: IP gateway
- connectivity: 2.4 GHz WIFI
- maximum number of connected clients: 50
- compatibility: EMOS GoSmart, TUYA, LIDL, Smartlife
- protocol: Wi-Fi/Zigbee 3.0/BLE/SigMesh
- pairing: automatic, manual
- use: automation
- number of control buttons: 1
- power supply: 5 V DC/1.0 A
- supported OS: Android, iOS



**H5001** 1/-/-/120  
30 69 050 010 IP-1000Z



- product: ZigBee repeater
- connectivity: 2.4 GHz WIFI
- compatibility: EMOS GoSmart, TUYA, LIDL, Smartlife
- protocol: Zigbee 3.0
- pairing: automatic, manual
- use: automation
- power supply: 5 V DC/1.0 A
- supported OS: Android, iOS



**H5022**  
30 69 052 030

1/-/60  
IP-2213Z

## Sockets



- Remote on/off switching of connected appliances
- Overview of electricity consumption of connected appliances
- Schedule creation and automatic ON/OFF settings
- Setting up delayed shutdown of appliances
- Network connection via WIFI or Bluetooth protocols
- Compatibility with EMOS GoSmart products and TUYA devices
- Voice control with Google Assistant and Amazon Alexa

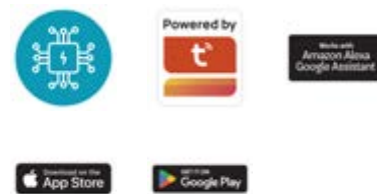

- product: Wi-Fi socket
- maximum load: 3 680 W
- voltage/current: 230 V~/16 A max.
- transmission frequency: 2.4 GHz WIFI
- children protection
- supported OS: Android, iOS
- compatibility: EMOS GoSmart, TUYA, LIDL, Smartlife
- protocol: Wi-Fi
- control by voice assistants
- notifications to the mobile app



**P5531**  
19 36 055 310

1/-/32  
IP-3002S

- product: Wi-Fi timer/wattmeter-outside
- maximum load: 3 680 W
- voltage/current: 230 V~/16 A max.
- transmission frequency: 2,4 GHz
- children protection
- supported OS: Android, iOS
- compatibility: EMOS GoSmart, TUYA, LIDL, Smartlife
- protocol: Wi-Fi
- control by voice assistants
- notifications to the mobile app



**P5532**  
19 36 055 320

1/-/30  
IP-3006S

- product: ZigBee socket
- maximum load: 3 680 W
- voltage/current: 230 V~/16 A max.
- transmission frequency: 2,4 GHz
- children protection
- supported OS: Android, iOS
- compatibility: EMOS GoSmart, TUYA, LIDL, Smartlife
- protocol: Zigbee 3.0
- control by voice assistants
- notifications to the mobile app



**P5533**  
19 36 553 300

1/-/32  
IP-3009S

- product: ZigBee socket
  - maximum load: 3 680 W
  - voltage/current: 230 V~/16 A max.
  - transmission frequency: 2,4 GHz
  - children protection
  - supported OS: Android, iOS
  - compatibility: EMOS GoSmart, TUYA, LIDL, Smartlife
  - protocol: Zigbee 3.0
  - control by voice assistants
- = notifications to the mobile app



**P5534**  
19 36 553 400

1/-/-/30  
IP-3010S

## Modules



- Remote control of connected devices
- Integration into home automation
- Variants for connection with or without the need for a neutral wire
- Easy installation under original switches
- Connection to the home network via WIFI/ZigBee protocol
- Compatibility with EMOS GoSmart products and TUYA devices
- Voice control with Google Assistant and Amazon Alexa

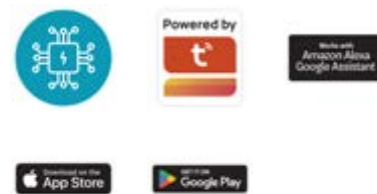

- product: IP switching module
  - connectivity: ZigBee 2.4 GHz
  - compatibility: EMOS GoSmart, TUYA, LIDL, Smartlife
  - control by voice assistants
  - protocol: Zigbee 3.0
  - pairing: automatic, manual
  - use: indoor
  - number of control buttons: 1
  - power supply: 230 V~/50 Hz, max. 0,3 W
- = supported OS: Android, iOS



**H5101**  
30 69 051 010

1/-/-/100  
IP-2101SZ

- product: IP switching module
  - connectivity: ZigBee 2.4 GHz
  - compatibility: EMOS GoSmart, TUYA, LIDL, Smartlife
  - control by voice assistants
  - protocol: Zigbee 3.0
  - pairing: automatic, manual
  - use: indoor
  - number of control buttons: 1
  - power supply: 230 V~/50 Hz, max. 0,3 W
- = supported OS: Android, iOS



**H5102**  
30 69 051 020

1/-/-/100  
IP-2102SZ

- product: IP switching module
  - connectivity: ZigBee 2.4 GHz
  - compatibility: EMOS GoSmart, TUYA, LIDL, Smartlife
  - control by voice assistants
  - protocol: Zigbee 3.0
  - pairing: automatic, manual
  - use: indoor
  - number of control buttons: 1
  - power supply: 230 V~/50 Hz, max. 0,3 W
- = supported OS: Android, iOS



**H5103**  
30 69 051 030

1/-/-/100  
IP-2103SZ





- product: IP switching module
  - connectivity: ZigBee 2.4 GHz
  - compatibility: EMOS GoSmart, TUYA, LIDL, Smartlife
  - control by voice assistants
  - protocol: Zigbee 3.0
  - pairing: automatic, manual
  - use: indoor
  - number of control buttons: 1
  - power supply: 230 V~/50 Hz, max. 0,3 W
- = supported OS: Android, iOS



**H5104**  
30 69 051 040

1/-/-/100  
IP-2104SZ



- product: IP switching module
  - connectivity: 2.4 GHz WIFI
  - compatibility: EMOS GoSmart, TUYA, LIDL, Smartlife
  - control by voice assistants
  - protocol: Wi-Fi
  - pairing: automatic, manual
  - use: indoor
  - number of control buttons: 1
  - power supply: 230 V~/50 Hz, max. 0,3 W
- = supported OS: Android, iOS



**H5105**  
30 69 051 050

1/-/-/100  
IP-2101SW



- product: IP switching module
  - connectivity: 2.4 GHz WIFI
  - compatibility: EMOS GoSmart, TUYA, LIDL, Smartlife
  - control by voice assistants
  - protocol: Wi-Fi
  - pairing: automatic, manual
  - use: indoor
  - number of control buttons: 1
  - power supply: 230 V~/50 Hz, max. 0,3 W
- = supported OS: Android, iOS



**H5106**  
30 69 051 060

1/-/-/100  
IP-2102SW



- product: IP dimming module
  - connectivity: ZigBee 2.4 GHz
  - compatibility: EMOS GoSmart, TUYA, LIDL, Smartlife
  - control by voice assistants
  - protocol: Zigbee 3.0
  - pairing: automatic, manual
  - use: indoor
  - number of control buttons: 1
  - power supply: 230 V~/50 Hz, max. 0,3 W
- = supported OS: Android, iOS



**H5107**  
30 69 051 070

1/-/-/100  
IP-2111DZ



- product: IP dimming module
  - connectivity: ZigBee 2.4 GHz
  - compatibility: EMOS GoSmart, TUYA, LIDL, Smartlife
  - control by voice assistants
  - protocol: Zigbee 3.0
  - pairing: automatic, manual
  - use: indoor
  - number of control buttons: 1
  - power supply: 230 V~/50 Hz, max. 0,3 W
- = supported OS: Android, iOS



**H5108**  
30 69 051 080

1/-/-/100  
IP-2112DZ





- product: IP motor module
  - connectivity: ZigBee 2.4 GHz
  - compatibility: EMOS GoSmart, TUYA, LIDL, Smartlife
  - control by voice assistants
  - protocol: Zigbee 3.0
  - pairing: automatic, manual
  - use: indoor
  - number of control buttons: 1
  - power supply: 230 V~/50 Hz, max. 0,3 W
- supported OS: Android, iOS



**H5109**  
30 69 051 090

1/-/-/100  
IP-2121CZ



- product: IP motor module
  - connectivity: ZigBee 2.4 GHz
  - compatibility: EMOS GoSmart, TUYA, LIDL, Smartlife
  - control by voice assistants
  - protocol: Zigbee 3.0
  - pairing: automatic, manual
  - use: indoor
  - number of control buttons: 1
  - power supply: 230 V~/50 Hz, max. 0,3 W
- supported OS: Android, iOS



**H5110**  
30 69 051 100

1/-/-/100  
IP-2122CZ



- product: IP motor module
  - connectivity: 2.4 GHz WIFI
  - compatibility: EMOS GoSmart, TUYA, LIDL, Smartlife
  - control by voice assistants
  - protocol: Wi-Fi/BLE
  - pairing: automatic, manual
  - use: indoor
  - number of control buttons: 1
  - power supply: 230 V~/50 Hz, max. 0,3 W
- supported OS: Android, iOS



**H5111**  
30 69 051 110

1/-/-/32  
IP-2131SW



# Measurement and Control

## Thermostats



- Reduce heating/cooling costs for buildings
- Individual temperature settings for different rooms
- Set temperature scenarios for specific day and time
- Control all settings from anywhere using the app
- Heating or air conditioning control based on GPS location
- Connection via WIFI or Zigbee protocols
- Compatibility with EMOS GoSmart products and TUYA devices
- Voice control with Google Assistant and Amazon Alexa

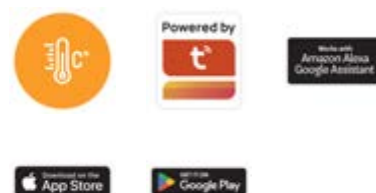

thermostat type: wire = type of control: programmable electronic room thermostat, option to control via mobile phone (iOS, Android) = backlight display = control mode: heating and cooling system = number of programs: customisable temperature (6× per day) = temperature adjustment type: 6 temperature changes per day = temperature measurement: 0 °C to 40 °C, resolution 0.1 °C = temperature adjustment: from 5 °C up to 35 °C, after 0.5 °C = anti-frost protection = ON/OFF function = holiday mode = switching: voltage 230 V AC, 50 Hz = switching load: 6 A resistive, 2 A inductive = power source: 230 V AC = dimensions: 138 × 88 × 33 mm



**P56201** 1/-/-12  
21 01 900 000 P56201

thermostat type: wireless = type of control: programmable electronic room thermostat, option to control via mobile phone (iOS, Android) = backlight display = control mode: heating and cooling system = number of programs: customisable temperature (6× per day) = temperature adjustment type: 6 temperature changes per day = temperature measurement: 0 °C to 40 °C, resolution 0.1 °C = temperature adjustment: from 5 °C up to 35 °C, after 0.5 °C = anti-frost protection = ON/OFF function = holiday mode = switching: 230 V AC or potential-free = switching load: 16 A resistive, 4 A inductive = power of transmitter: 5 V USB adapter (included) = power of receiver: 230 V AC = receiver's dimension: 37 × 86 × 86 mm = transmitter's dimension: 40 × 138 × 96 mm



**P56211** 1/-/-9  
21 01 900 001 P56211

thermostat type: wired for underfloor heating, concealed = type of control: programmable electronic room thermostat, option to control via mobile phone (iOS, Android) = backlight display = control mode: heating system = number of programs: customisable temperature (6× per day) = temperature adjustment type: 6 temperature changes per day = temperature measurement: 0 °C to 95 °C, resolution 0.5 °C = temperature adjustment: from 1 °C up to 70 °C, after 0.5 °C = anti-frost protection = ON/OFF function = holiday mode = switching: voltage 230 V AC, 50 Hz = switching load: 16 A resistive = power source: 230 V AC = dimensions: 86 × 86 × 43 mm = part of the package: thermostat, floor sensor 3 m, Ø 8 mm



**P56201UF** 1/-/-36  
21 01 900 002 P56201UF



thermo shut-off valve: SMART, programmable = number of programs: 1 customisable programme or customisable temperature (6× per day) = temperature adjustment type: 6 temperature changes per day = temperature measurement: 0 °C to 70 °C, resolution 0.5 °C = temperature adjustment: 1 °C to 70 °C, resolution 0.5 °C = anti-frost protection = holiday mode = open window function = child lock = matrix: M30 × 1.5 mm = enclosed adaptors: Danfoss RA, RAV, RAVL = power source: 2× 1.5 V AA (included) = dimensions: 55 × 94 × 55 mm = packaging: 1 pc, small box



**P5630S** 1/-/-/24  
21 01 900 003 P5630S

## Weather stations and Thermometers



- For measuring indoor temperature and humidity
- Display temperature and humidity data history in the app
- Temperature and humidity alerts via alarm
- Small size and elegant design
- Battery powered
- Connection to home network via ZigBee protocol
- Compatibility with EMOS GoSmart products and TUYA devices
- Voice control with Google Assistant and Amazon Alexa



- thermometer design: wireless – smart
- indoor temperature: -20 °C to +60 °C, resolution 0.1
- indoor humidity: 0 % to 99 % RH, resolution 1 %
- temperature warning
- the possibility of hanging on the wall
- power of station: 1× 3 V CR2032 (included)
- main unit size: 26 × 13 × 52 mm



**EGS0102** 1/-/-/80  
26 03 122 000 EGS0102

- thermometer design: wireless – smart
- clock: wifi
- LED backlight display
- date
- indoor temperature: -10 °C to +60 °C, resolution 0.1
- indoor humidity: 0 % to 99 % RH, resolution 1 %
- min. and max. temperature
- temperature warning
- the possibility of hanging on the wall
- power of station: 3× 1.5 V AAA (not included)
- main unit size: 56 × 23 × 56 mm
- screen size: 42 × 40 mm



**EGS0101** 1/-/-/80  
26 03 123 000 EGS0101



## Air quality



- Overview of the CO<sub>2</sub> level in the monitored room
- Display of indoor temperature, humidity and hours
- LED display with permanent backlight
- Colour animation of air quality
- Built-in alarm for elevated CO<sub>2</sub> concentration
- Connection to home network via WIFI protocol
- Compatibility with EMOS GoSmart products and TUYA devices

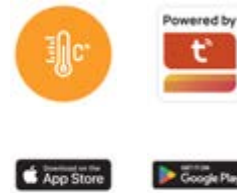

- option to set the temperature unit: °C/°F
- CO<sub>2</sub> alert
- setting CO<sub>2</sub> alert limits
- CO<sub>2</sub> level indicator
- CO<sub>2</sub> measurement range: 400 to 5 000 PPM
- indoor temperature: 0 °C to +50 °C, resolution 0.1°C
- indoor humidity: 20 % to 90 % RH, resolution 1 %
- supported OS: Android, iOS
- compatibility: EMOS GoSmart, TUYA, LIDL, Smartlife
- protocol: Wi-Fi
- transmission frequency: 2.4 GHz Wi-Fi
- notifications to the mobile app
- application languages: EN, CZ, SK, PL, DE, HU, SI, FR,



**E30300** 1/-/-/12  
26 27 303 000 E30300

## Control valves



- Manual and automatic control
- Timer function for setting a schedule
- High power and torque
- Immediate response to crash detection
- Connection to home network via ZIGBEE protocol
- Compatibility with EMOS GoSmart products and TUYA devices
- Voice control with Google Assistant and Amazon Alexa

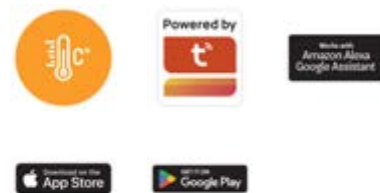

- product: valve controller
- pipe diameter: 1/2", 3/4", 1" a 1 1/4"
- torque: max. 5.88 Nm
- operating temperature: -10 °C to 55 °C
- operating humidity: <95 %
- IP rating: IP20
- power source: DC 12 V/1 000 mA, 1.4 m (included)
- supported OS: Android, iOS
- compatibility: EMOS GoSmart, TUYA, LIDL, Smartlife
- protocol: Zigbee 3.0
- transmission frequency: 2.4 GHz Wi-Fi
- notifications to the mobile app
- control by voice assistants
- application languages: EN, CZ, SK, PL, DE, HU, SI, FR,



**P5640S** 1/-/-/12  
21 05 564 000 P5640S

# Household and Garden

## Bathroom Scales



- Wide range of measuring indicators
- Clear reports in graphical form
- Memory for several users
- Elegant design
- Weighing accuracy to 100 g, max. load capacity 180 kg
- Connection to home network via Bluetooth
- Compatibility with EMOS GoSmart products and TUYA devices



- backlight display
- scale surface: ITO tempered glass
- maximum load: 180 kg
- Bluetooth
- BMI – measurement of fat, water and muscle
- weight units: kg, lb
- memory: 10 persons max.
- power source: 3× 1.5 V AAA (included)
- dimensions: 26 × 300 × 300 mm
- supported OS: Android, iOS
- compatibility: EMOS GoSmart, TUYA, LIDL, Smartlife,
- protocol: Wi-Fi
- transmission frequency: 2.4 GHz Wi-Fi
- notifications to the mobile app
- application languages: EN, CZ, SK, PL, DE, HU, SI, FR,



8 592920 122129

EV112

26 17 010 902

1/-/-/3

EV112





# Batteries

## GP Batteries

## GP Consumer batteries

## GP Alkaline

### GP Ultra Plus



- most powerful line of GP alkaline batteries
- for demanding devices requiring maximum performance
- up to 200 % more power than standard alkaline batteries
- long lasting performance
- operating temperature from -20 °C to +54 °C
- shelf life up to 10 years



- chemical constitution: alkaline
- type: LR03 (AAA battery)
- voltage: 1.5 V
- dimensions: 10.5 × 44.5 mm
- weight: 13 g
- operating temperature: -20 °C to +54 °C
- packaging: 2 pcs, small paper box



**B03112** 2/-/20/160  
10 13 122 000 GP 24AUP

- chemical constitution: alkaline
- type: LR03 (AAA battery)
- voltage: 1.5 V
- dimensions: 10.5 × 44.5 mm
- weight: 13 g
- operating temperature: -20 °C to +54 °C
- packaging: 4 pcs, small paper box



**B03114** 4/-/40/320  
10 13 124 000 GP 24AUP



www.emos.eu

Order Code  
Item Number

Packaging  
Type

- chemical constitution: alkaline
- type: LR03 (AAA battery)
- voltage: 1.5 V
- dimensions: 10.5 × 44.5 mm
- weight: 13 g
- operating temperature: -20 °C to +54 °C
- packaging: 10 pc, small paper box



**B0314G** 10/-/100/400  
10 17 101 000 GPPCA24UP

- chemical constitution: alkaline
- type: LR6 (AA battery)
- voltage: 1.5 V
- dimensions: 14.5 × 50.5 mm
- weight: 24 g
- operating temperature: -20 °C to +54 °C
- packaging: 2 pcs, small paper box



**B03212** 2/-/20/160  
10 13 222 000 GP 15AUP

- chemical constitution: alkaline
- type: LR6 (AA battery)
- voltage: 1.5 V
- dimensions: 14.5 × 50.5 mm
- weight: 24 g
- operating temperature: -20 °C to +54 °C
- packaging: 4 pcs, small paper box



**B03214** 4/-/40/320  
10 13 224 000 GP 15AUP

- chemical constitution: alkaline
- type: LR6 (AA battery)
- voltage: 1.5 V
- dimensions: 14.5 × 50.5 mm
- weight: 28 g
- operating temperature: -20 °C to +54 °C
- packaging: 10 pc, small paper box



**B0324G** 10/-/100/400  
10 17 201 000 GP15AUP

- chemical constitution: alkaline
- type: LR14 (C battery)
- voltage: 1.5 V
- dimensions: 26.2 × 50.0 mm
- weight: 70 g
- operating temperature: -18 °C to +50 °C
- packaging: 2 pcs, small paper box



**B03312** 2/-/20/160  
10 13 322 000 GP 14AUP



www.emos.eu

Order Code  
Item Number

Packaging  
Type

- chemical constitution: alkaline
- type: LR20 (D battery)
- voltage: 1.5 V
- dimensions: 34.2 × 61.5 mm
- weight: 142 g
- operating temperature: -18 °C to +50 °C
- packaging: 2 pcs, small paper box



**B03412**

2/-/20/80

10 13 422 000

GP 13AUP

- chemical constitution: alkaline
- type: 6LR61 9 V
- voltage: 9 V
- dimensions: 26.5 × 17.5 × 48.5 mm
- weight: 47 g
- operating temperature: -18 °C to +50 °C
- packaging: 1 pc, small paper box



**B03511**

1/-/10/200

10 13 521 000

GP 1604AUP

## GP Ultra



- suitable for devices with medium power consumption
- up to 80 % more power than standard alkaline batteries
- operating temperature from -20 °C to +54 °C
- shelf life up to 10 years



- chemical constitution: alkaline
- type: LR03 (AAA battery)
- voltage: 1.5 V
- dimensions: 10.5 × 44.5 mm
- weight: 11.5 g
- operating temperature: -18 °C to +50 °C
- packaging: 2 pcs, small paper box



**B02112**

2/-/20/160

10 14 122 000

GP 24A

- chemical constitution: alkaline
- type: LR03 (AAA battery)
- voltage: 1.5 V
- dimensions: 10.5 × 44.5 mm
- weight: 11.5 g
- operating temperature: -18 °C to +50 °C
- packaging: 4 pcs, small paper box



**B02114**

4/-/40/320

10 13 124 100

GP 24AU





www.emos.eu

Order Code  
Item Number

Packaging  
Type

- chemical constitution: alkaline
- type: LR03 (AAA battery)
- voltage: 1.5 V
- dimensions: 10.5 × 44.5 mm
- weight: 11.5 g
- operating temperature: -18 °C to +50 °C
- packaging: 6 pcs, small paper box



**B0211V** 6/-/72/864  
10 13 126 000 GP 24AU

- chemical constitution: alkaline
- type: LR03 (AAA battery)
- voltage: 1.5 V
- dimensions: 10.5 × 44.5 mm
- weight: 11.5 g
- operating temperature: -18 °C to +50 °C
- packaging: 8 pcs, small paper box



**B02118** 8/-/96/768  
10 13 128 100 GP 24AU

- chemical constitution: alkaline
- type: LR6 (AA battery)
- voltage: 1.5 V
- dimensions: 14.5 × 50.5 mm
- weight: 23 g
- operating temperature: -18 °C to +50 °C
- packaging: 2 pcs, small paper box



**B02212** 2/-/20/160  
10 14 222 000 GP 15A

- chemical constitution: alkaline
- type: LR6 (AA battery)
- voltage: 1.5 V
- dimensions: 14.5 × 50.5 mm
- weight: 23 g
- operating temperature: -18 °C to +50 °C
- packaging: 4 pcs, small paper box



**B02214** 4/-/40/320  
10 13 224 100 GP 15AU

- chemical constitution: alkaline
- type: LR6 (AA battery)
- voltage: 1.5 V
- dimensions: 14.5 × 50.5 mm
- weight: 23 g
- operating temperature: -18 °C to +50 °C
- packaging: 6 pcs, small paper box



**B0221V** 6/-/72/576  
10 13 226 000 GP 15AU



www.emos.eu

Order Code  
Item Number

Packaging  
Type

- chemical constitution: alkaline
- type: LR6 (AA battery)
- voltage: 1.5 V
- dimensions: 14.5 × 50.5 mm
- weight: 23 g
- operating temperature: -18 °C to +50 °C
- packaging: 8 pcs, small paper box



**B02218**

8-/-96/576

10 13 228 100

GP 15AU

- chemical constitution: alkaline
- type: LR14 (C battery)
- voltage: 1.5 V
- dimensions: 26.2 × 50.0 mm
- weight: 68 g
- operating temperature: -18 °C to +50 °C
- packaging: 2 pcs, small paper box



**B02312**

2-/-20/160

10 13 322 100

GP 14AU

- chemical constitution: alkaline
- type: LR20 (D battery)
- voltage: 1.5 V
- dimensions: 34.2 × 61.5 mm
- weight: 140 g
- operating temperature: -18 °C to +50 °C
- packaging: 2 pcs, small paper box



**B02412**

2-/-20/80

10 13 422 100

GP 13AU

- chemical constitution: alkaline
- type: 6LR61 9 V
- voltage: 9 V
- dimensions: 26.5 × 17.5 × 48.5 mm
- weight: 47 g
- operating temperature: -18 °C to +50 °C
- packaging: 1 pc, small paper box



**B02511**

1-/-10/200

10 13 521 100

GP 1604AU

# GP Super



- basic series of GP alkaline batteries
- for use in devices with low power consumption
- up to 7× more energy than standard zinc-carbon batteries
- operating temperature from -20 °C to +54 °C
- shelf life up to 10 years



- chemical constitution: alkaline
- type: LR03 (AAA battery)
- voltage: 1.5 V
- dimensions: 10.5 × 44.5 mm
- weight: 11.5 g
- operating temperature: -18 °C to +50 °C
- packaging: 2 pcs, shrink



**B01102** 2/40/200/1 000  
10 13 102 002 GP24A

- chemical constitution: alkaline
- type: LR03 (AAA battery)
- voltage: 1.5 V
- dimensions: 10.5 × 44.5 mm
- weight: 11.5 g
- operating temperature: -18 °C to +50 °C
- packaging: 4 pcs, small paper box



**B01114** 4/-/40/320  
10 13 124 200 GP 24A

- chemical constitution: alkaline
- type: LR03 (AAA battery)
- voltage: 1.5 V
- dimensions: 10.5 × 44.5 mm
- weight: 11.5 g
- operating temperature: -18 °C to +50 °C
- packaging: 8 pcs, small paper box



**B01118** 8/-/96/768  
10 13 128 000 GP 24A

- chemical constitution: alkaline
- type: LR03 (AAA battery)
- voltage: 1.5 V
- dimensions: 10.5 × 44.5 mm
- weight: 11.5 g
- operating temperature: -18 °C to +50 °C
- packaging: 10 pc, small paper box



**B0111G** 10/-/60/480  
10 13 121 001 GP 24A





www.emos.eu

Order Code  
Item Number

Packaging  
Type

- chemical constitution: alkaline
- type: LR03 (AAA battery)
- voltage: 1.5 V
- dimensions: 10.5 × 44.5 mm
- weight: 11.5 g
- operating temperature: -18 °C to +50 °C
- packaging: 20 pcs, shrink



**B0110L** 20/-/320/960  
10 13 122 001 GP 24A

- chemical constitution: alkaline
- type: LR03 (AAA battery)
- voltage: 1.5 V
- dimensions: 10.5 × 44.5 mm
- weight: 11.5 g
- operating temperature: -18 °C to +50 °C
- packaging: 288 pcs, display box



**B0114T** 288/-/288/1 152  
10 13 101 201 GP 24A

- chemical constitution: alkaline
- type: LR6 (AA battery)
- voltage: 1.5 V
- dimensions: 14.5 × 50.5 mm
- weight: 23 g
- operating temperature: -18 °C to +50 °C
- packaging: 2 pcs, shrink



**B01202** 2/40/200/600  
10 13 202 002 GP 15A

- chemical constitution: alkaline
- type: LR6 (AA battery)
- voltage: 1.5 V
- dimensions: 14.5 × 50.5 mm
- weight: 23 g
- operating temperature: -18 °C to +50 °C
- packaging: 4 pcs, small paper box



**B01214** 4/-/40/320  
10 13 224 200 GP 15A

- chemical constitution: alkaline
- type: LR6 (AA battery)
- voltage: 1.5 V
- dimensions: 14.5 × 50.5 mm
- weight: 23 g
- operating temperature: -18 °C to +50 °C
- packaging: 8 pcs, small paper box



**B01218** 8/-/96/576  
10 13 228 000 GP 15A



www.emos.eu

Order Code  
Item Number

Packaging  
Type

- chemical constitution: alkaline
- type: LR6 (AA battery)
- voltage: 1.5 V
- dimensions: 14.5 × 50.5 mm
- weight: 23 g
- operating temperature: -18 °C to +50 °C
- packaging: 10 pc, small paper box



**B0121G** 10/-/60/480  
10 13 221 001 GP 15A

- chemical constitution: alkaline
- type: LR6 (AA battery)
- voltage: 1.5 V
- dimensions: 14.5 × 50.5 mm
- weight: 23 g
- operating temperature: -18 °C to +50 °C
- packaging: 20 pcs, shrink



**B0120L** 20/-/240/480  
10 13 222 001 GP 15A

- chemical constitution: alkaline
- type: LR6 (AA battery)
- voltage: 1.5 V
- dimensions: 14.5 × 50.5 mm
- weight: 23 g
- operating temperature: -18 °C to +50 °C
- packaging: 288 pcs, display box



**B0124T** 288/-/-/576  
10 13 201 201 GP 15A

- chemical constitution: alkaline
- type: LR14 (C battery)
- voltage: 1.5 V
- dimensions: 26.2 × 50.0 mm
- weight: 68 g
- operating temperature: -18 °C to +50 °C
- packaging: 2 pcs, shrink



**B01302** 2/-/24/192  
10 13 302 001 GP 14A

- chemical constitution: alkaline
- type: LR14 (C battery)
- voltage: 1.5 V
- dimensions: 26.2 × 50.0 mm
- weight: 68 g
- operating temperature: -18 °C to +50 °C
- packaging: 4 pcs, shrink



**B01304** 4/48/-/192  
10 13 304 001 GP 14A



www.emos.eu

Order Code  
Item Number

Packaging  
Type

- chemical constitution: alkaline
- type: LR14 (C battery)
- voltage: 1.5 V
- dimensions: 26.2 × 50.0 mm
- weight: 68 g
- operating temperature: -18 °C to +50 °C
- packaging: 2 pcs, small paper box



**B01312**

2/-/20/160

10 13 322 200

GP 14A

- chemical constitution: alkaline
- type: LR20 (D battery)
- voltage: 1.5 V
- dimensions: 34.2 × 61.5 mm
- weight: 140 g
- operating temperature: -18 °C to +50 °C
- packaging: 2 pcs, shrink



**B01402**

2/-/20/80

10 13 402 001

GP 13A

- chemical constitution: alkaline
- type: LR20 (D battery)
- voltage: 1.5 V
- dimensions: 34.2 × 61.5 mm
- weight: 140 g
- operating temperature: -18 °C to +50 °C
- packaging: 4 pcs, shrink



**B01404**

4/48/-/96

10 13 404 001

GP 13A

- chemical constitution: alkaline
- type: LR20 (D battery)
- voltage: 1.5 V
- dimensions: 34.2 × 61.5 mm
- weight: 140 g
- operating temperature: -18 °C to +50 °C
- packaging: 2 pcs, small paper box



**B01412**

2/-/20/80

10 13 422 200

GP 13A

- chemical constitution: alkaline
- type: 6LR61 9 V
- voltage: 9 V
- dimensions: 26.5 × 17.5 × 48.5 mm
- weight: 47 g
- operating temperature: -18 °C to +50 °C
- packaging: 1 pc, shrink



**B01501**

1/10/50/300

10 13 501 001

GP 1604A



- chemical constitution: alkaline
- type: 6LR61 9 V
- voltage: 9 V
- dimensions: 26.5 × 17.5 × 48.5 mm
- weight: 47 g
- operating temperature: -18 °C to +50 °C
- packaging: 1 pc, small paper box



**B01511**

1/-/10/200

10 13 521 200

GP 1604A

- chemical constitution: alkaline
- type: LR6 (AA battery)/LR03 (AAA battery)
- voltage: 1.5 V
- weight: 23 g
- operating temperature: -18 °C to +50 °C
- packaging: 2 304 pcs (AA) + 1 728 pcs (AAA)



**B0125T**

1/-/-/1

10 13 800 000

GP 15A

## GP Batteries

## GP Consumer batteries

## GP Carbon Zinc

## GP Greencell



- advanced version of zinc-carbon batteries
- operating temperature from -20 °C to +40 °C
- shelf life up to 3 years



- chemical constitution: zinc-chloride
- type: R6 (AA battery)
- voltage: 1.5 V
- dimensions: 14.5 × 50.5 mm
- weight: 17.3 g
- operating temperature: 0 °C to +45 °C
- packaging: 4 pcs, shrink



**B1220**

4/40/200/1 000

10 12 204 000

GP 15G





- chemical constitution: zinc-chloride
- type: R6 (AA battery)
- voltage: 1.5 V
- dimensions: 14.5 × 50.5 mm
- weight: 17.3 g
- operating temperature: 0 °C to +45 °C
- packaging: 12 pcs, shrink



**B1220F** 12-/204/612  
10 12 209 002 GP 15G

- chemical constitution: zinc-chloride
- type: R6 (AA battery)
- voltage: 1.5 V
- dimensions: 14.5 × 50.5 mm
- weight: 17.3 g
- operating temperature: 0 °C to +45 °C
- packaging: 4 pcs, blister



**B1221** 4-/172/288  
10 12 214 000 GP 15G

- chemical constitution: zinc-chloride
- type: R03 (AAA battery)
- voltage: 1.5 V
- dimensions: 10.5 × 44.5 mm
- weight: 8.5 g
- operating temperature: 0 °C to +45 °C
- packaging: 4 pcs, shrink



**B12104** 4/40/200/1 000  
10 12 104 000 GP 24G

- chemical constitution: zinc-chloride
- type: R03 (AAA battery)
- voltage: 1.5 V
- dimensions: 10.5 × 44.5 mm
- weight: 8.5 g
- operating temperature: 0 °C to +45 °C
- packaging: 12 pcs, shrink



**B1210F** 12-/204/612  
10 12 109 002 GP 24G

- chemical constitution: zinc-chloride
- type: R03 (AAA battery)
- voltage: 1.5 V
- dimensions: 10.5 × 44.5 mm
- weight: 8.5 g
- operating temperature: 0 °C to +45 °C
- packaging: 4 pcs, blister



**B1211** 4-/40/480  
10 12 114 000 GP 24G

- chemical constitution: zinc-chloride
- type: R14 (C battery)
- voltage: 1.5 V
- dimensions: 26.2 × 50.0 mm
- weight: 48 g
- operating temperature: 0 °C to +45 °C
- packaging: 2 pcs, shrink



**B1230** 2/-/24/240  
10 12 302 000 GP 14G

- chemical constitution: zinc-chloride
- type: R14 (C battery)
- voltage: 1.5 V
- dimensions: 26.2 × 50.0 mm
- weight: 48 g
- operating temperature: 0 °C to +45 °C
- packaging: 2 pcs, blister



**B1231** 2/-/20/240  
10 12 312 000 GP 14G

- chemical constitution: zinc-chloride
- type: R20 (D battery)
- voltage: 1.5 V
- dimensions: 34.2 × 61.5 mm
- weight: 97 g
- operating temperature: 0 °C to +45 °C
- packaging: 2 pcs, shrink



**B1240** 2/-/20/120  
10 12 402 000 GP 13G

- chemical constitution: zinc-chloride
- type: R20 (D battery)
- voltage: 1.5 V
- dimensions: 34.2 × 61.5 mm
- weight: 97 g
- operating temperature: 0 °C to +45 °C
- packaging: 2 pcs, blister



**B1241** 2/-/20/120  
10 12 412 000 GP 13G

- chemical constitution: zinc-chloride
- type: 6F22 9 V (1604)
- voltage: 9 V
- dimensions: 26.5 × 17.5 × 48.5 mm
- weight: 36 g
- operating temperature: 0 °C to +45 °C
- packaging: 1 pc, shrink



**B1250** 1/10/-/300  
10 12 501 000 GP 1604GLF



www.emos.eu

Order Code  
Item Number

Packaging  
Type

- chemical constitution: zinc-chloride
- type: 6F22 9 V (1604)
- voltage: 9 V
- dimensions: 26.5 × 17.5 × 48.5 mm
- weight: 36 g
- operating temperature: 0 °C to +45 °C
- packaging: 1 pc, blister



**B1251** 1/-/10/200  
10 12 511 000 GP 1604GLF

- chemical constitution: zinc-chloride
- type: 3R12 4.5 V (lantern battery)
- voltage: 4.5 V
- dimensions: 62 × 22 × 67 mm
- weight: 115 g
- operating temperature: 0 °C to +45 °C
- packaging: 1 pc, shrink



**B1260** 1/-/20/120  
10 12 601 000 GP 312G

## GP Supercell

- for devices with low power consumption
- operating temperature from -20 °C to +40 °C
- shelf life up to 3 years



- chemical constitution: zinc-carbon
- type: R6 (AA battery)
- voltage: 1.5 V
- dimensions: 14.5 × 50.5 mm
- weight: 14.6 g
- operating temperature: 0 °C to +45 °C
- packaging: 2 pcs, shrink



**B11202** 2/40/200/800  
10 11 202 001 GP 15PL

- chemical constitution: zinc-carbon
- type: R03 (AAA battery)
- voltage: 1.5 V
- dimensions: 10.5 × 44.5 mm
- weight: 8.5 g
- operating temperature: 0 °C to +45 °C
- packaging: 2 pcs, shrink



**B1110** 2/40/200/1 000  
10 11 102 000 GP 24PL

# GP Batteries

## GP Consumer batteries

### GP Other batteries

## GP Lithium cylindrical



- 1/3rd lighter and 7× stronger than standard alkaline batt.
- use modern technologies for maximum battery safety
- best choice for professionals
- for capturing up to 800 photos
- outstanding performance at high power consumption
- ideal for extremes of between -40 °C to +60 °C
- extremely long shelf life of up to 10 years



- chemical constitution: lithium
- type: FR6 (AA battery)
- voltage: 1.5 V
- dimensions: 14.5 × 50.5 mm
- weight: 14.5 g
- operating temperature: -40 °C to +60 °C
- packaging: 2 pcs, blister



**B15212**

2/-/20/160

10 22 000 711

GP 15LF

- chemical constitution: lithium
- type: FR03 (AAA battery)
- voltage: 1.5 V
- dimensions: 10.5 × 44.5 mm
- weight: 7.5 g
- operating temperature: -30 °C to +60 °C
- packaging: 2 pcs, blister



**B15112**

2/-/20/160

10 22 000 412

GP 24LF

- chemical constitution: lithium
- type: CR-V9 (U9VL,1604LC)
- voltage: 9 V
- dimensions: 26.5 × 17.5 × 48.5 mm
- weight: 34 g
- operating temperature: -40 °C to +60 °C
- packaging: 1 pc, blister



**B1509**

1/-/10/450

10 22 000 911

GP CR-V9





www.emos.eu

Order Code  
Item Number

Packaging  
Type

- chemical constitution: lithium
- type: CR123A (CR123AP, CR17345)
- voltage: 3 V
- capacity: 1 500 mAh
- dimensions: 17.0 × 34.5 mm
- weight: 16 g
- operating temperature: -40 °C to +60 °C
- packaging: 1 pc, blister



**B1501**

1/-/10/450

10 22 000 111

GP CR123A

- chemical constitution: lithium
- type: CR-P2 (EL223AP, DL223A)
- voltage: 6 V
- capacity: 1 400 mAh
- dimensions: 34.8 × 19.5 × 35.8 mm
- weight: 37 g
- operating temperature: -40 °C to +60 °C
- packaging: 1 pc, blister



**B1502**

1/-/10/450

10 22 000 211

GP CR-P2

- chemical constitution: lithium
- type: 2CR5 (EL2CR5BP, DL245)
- voltage: 6 V
- capacity: 1 400 mAh
- dimensions: 34 × 17 × 45 mm
- weight: 40 g
- operating temperature: -40 °C to +60 °C
- packaging: 1 pc, blister



**B1505**

1/10/-/450

10 22 000 511

GP 2CR5

- chemical constitution: lithium
- type: CR2 (DLCR2)
- voltage: 3 V
- capacity: 800 mAh
- dimensions: 15.3 × 26.5 mm
- weight: 10 g
- operating temperature: -40 °C to +60 °C
- packaging: 1 pc, blister



**B1506**

1/-/10/450

10 22 000 611

GP CR2

- chemical constitution: lithium
- type: CR123A (CR123A Econ, CR17345)
- voltage: 3 V
- capacity: 1 400 mAh
- dimensions: 17.0 × 34.5 mm
- weight: 16 g
- operating temperature: -40 °C to +60 °C
- packaging: 1 pc, blister



**B1501E**

1/-/10/450

10 22 000 114

CR123AE

## GP Lithium button



- wide range of packaging, size and model
- wide range of operating temperatures: -10 °C to +60 °C
- shelf life up to 10 years

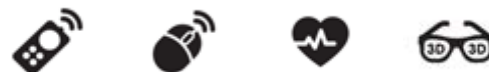

- chemical constitution: lithium
- type: GP CR1/3N
- voltage: 3 V
- capacity: 160 mAh
- dimensions: 11.6 × 10.8 mm
- weight: 3.3 g
- operating temperature: -20 °C to +60 °C
- packaging: 1 pc, blister



4 891199 028175

**B15711**

1/-/10/720

10 42 103 011

GP CR1/3N

- chemical constitution: lithium
- type: GP CR1025
- voltage: 3 V
- capacity: 30 mAh
- dimensions: 10.0 × 2.5 mm
- weight: 0.7 g
- operating temperature: -20 °C to +60 °C
- packaging: 1 pc, blister



4 891199 211485

**B15101**

1/-/10/900

10 42 102 511

GP CR1025

- chemical constitution: lithium
- type: GP CR1216
- voltage: 3 V
- capacity: 30 mAh (discharge load 30 kOhm)
- dimensions: 12.5 × 1.6 mm
- weight: 0.6 g
- operating temperature: -20 °C to +60 °C
- packaging: 1 pc, blister



4 891199 028144

**B15651**

1/10/100/900

10 42 121 611

GP CR1216

- chemical constitution: lithium
- type: GP CR1220
- voltage: 3 V
- capacity: 36 mAh (discharge load 30 kOhm)
- dimensions: 12.5 × 2.0 mm
- weight: 0.8 g
- operating temperature: -20 °C to +60 °C
- packaging: 1 pc, blister



4 891199 004346

**B15201**

1/10/100/900

10 42 122 011

GP CR1220



www.emos.eu

Order Code  
Item Number

Packaging  
Type

- chemical constitution: lithium
- type: GP CR1220
- voltage: 3 V
- capacity: 36 mAh (discharge load 30 kOhm)
- dimensions: 12.5 × 2.0 mm
- weight: 0.8 g
- operating temperature: -20 °C to +60 °C
- packaging: 5 pcs, blister



**B1520** 5/-/100/2 000  
10 42 122 015 GP CR1220

- chemical constitution: lithium
- type: GP CR1225
- voltage: 3 V
- capacity: 62 mAh
- dimensions: 12.5 × 2.5 mm
- weight: 1.0 g
- operating temperature: -20 °C to +60 °C
- packaging: 1 pc, blister



**B15221** 1/10/100/900  
10 42 122 511 GP CR1225

- chemical constitution: lithium
- type: GP CR1616
- voltage: 3 V
- capacity: 50 mAh
- dimensions: 16.0 × 1.6 mm
- weight: 1.1 g
- operating temperature: -20 °C to +60 °C
- packaging: 1 pc, blister



**B15601** 1/10/100/900  
10 42 161 611 GP CR1616

- chemical constitution: lithium
- type: GP CR1620
- voltage: 3 V
- capacity: 75 mAh
- dimensions: 16.0 × 2.0 mm
- weight: 1.3 g
- operating temperature: -20 °C to +60 °C
- packaging: 1 pc, blister



**B15701** 1/10/100/900  
10 42 162 011 GP CR1620

- chemical constitution: lithium
- type: GP CR1620
- voltage: 3 V
- capacity: 75 mAh
- dimensions: 16.0 × 2.0 mm
- weight: 1.3 g
- operating temperature: -20 °C to +60 °C
- packaging: 5 pcs, blister



**B1570** 5/-/100/2 000  
10 42 162 015 GP CR1620



www.emos.eu

Order Code  
Item Number

Packaging  
Type

- chemical constitution: lithium
- type: GP CR1632
- voltage: 3 V
- capacity: 140 mAh
- dimensions: 16.0 × 3.2 mm
- weight: 1.8 g
- operating temperature: -20 °C to +60 °C
- packaging: 1 pc, blister



**B15951** 1/10/100/900  
10 42 163 221 GP CR1632

- chemical constitution: lithium
- type: GP CR2016
- voltage: 3 V
- capacity: 90 mAh
- dimensions: 20.0 × 1.6 mm
- weight: 1.5 g
- operating temperature: -20 °C to +60 °C
- packaging: 1 pc, blister



**B15161** 1/10/100/900  
10 42 201 611 GP CR2016

- chemical constitution: lithium
- type: GP CR2016
- voltage: 3 V
- capacity: 90 mAh
- dimensions: 20.0 × 1.6 mm
- weight: 1.5 g
- operating temperature: -20 °C to +60 °C
- packaging: 2 pcs, blister



**B15163** 2/-/20/720  
10 42 201 612 GP CR2016

- chemical constitution: lithium
- type: GP CR2016
- voltage: 3 V
- capacity: 90 mAh
- dimensions: 20.0 × 1.6 mm
- weight: 1.5 g
- operating temperature: -20 °C to +60 °C
- packaging: 5 pcs, blister



**B1516** 5/-/100/2 000  
10 42 201 615 GP CR2016

- chemical constitution: lithium
- type: GP CR2025
- voltage: 3 V
- capacity: 165 mAh
- dimensions: 20.0 × 2.5 mm
- weight: 2.5 g
- operating temperature: -20 °C to +60 °C
- packaging: 1 pc, blister



**B15251** 1/10/100/900  
10 42 202 511 GP CR2025





www.emos.eu

Order Code  
Item Number

Packaging  
Type

- chemical constitution: lithium
- type: GP CR2025
- voltage: 3 V
- capacity: 165 mAh
- dimensions: 20.0 × 2.5 mm
- weight: 2.5 g
- operating temperature: -20 °C to +60 °C
- packaging: 2 pcs, blister



**B15253** 2/-/20/720  
10 42 202 512 GP CR2025

- chemical constitution: lithium
- type: GP CR2025
- voltage: 3 V
- capacity: 165 mAh
- dimensions: 20.0 × 2.5 mm
- weight: 2.5 g
- operating temperature: -20 °C to +60 °C
- packaging: 5 pcs, blister



**B1525** 5/-/100/2 000  
10 42 202 515 GP CR2025

- chemical constitution: lithium
- type: GP CR2032
- voltage: 3 V
- capacity: 240 mAh
- dimensions: 20.0 × 3.2 mm
- weight: 3.1 g
- operating temperature: -20 °C to +60 °C
- packaging: 1 pc, blister



**B15322** 1/10/100/900  
10 42 203 211 GP CR2032

- chemical constitution: lithium
- type: GP CR2032
- voltage: 3 V
- capacity: 240 mAh
- dimensions: 20.0 × 3.2 mm
- weight: 3.1 g
- operating temperature: -20 °C to +60 °C
- packaging: 2 pcs, blister



**B15323** 2/20/-/720  
10 42 203 212 GP CR2032

- chemical constitution: lithium
- type: GP CR2032
- voltage: 3 V
- capacity: 240 mAh
- dimensions: 20.0 × 3.2 mm
- weight: 3.1 g
- operating temperature: -20 °C to +60 °C
- packaging: 5 pcs, blister



**B1532** 5/-/100/2 000  
10 42 203 215 GP CR2032

- chemical constitution: lithium
- type: GP CR2320
- voltage: 3 V
- capacity: 130 mAh
- dimensions: 23.0 × 2.0 mm
- weight: 3,0 g
- operating temperature: -20 °C to +60 °C
- packaging: 1 pc, blister



**B15451** 1/-/10/900  
10 42 232 011 GP CR2320

- chemical constitution: lithium
- type: GP CR2325
- voltage: 3 V
- capacity: 190 mAh
- dimensions: 23.0 × 2.5 mm
- weight: 3,3 g
- operating temperature: -20 °C to +60 °C
- packaging: 1 pc, blister



**B15431** 1/-/10/900  
10 42 232 511 GP CR2325

- chemical constitution: lithium
- type: GP CR2330
- voltage: 3 V
- capacity: 260 mAh
- dimensions: 23.0 × 3.0 mm
- weight: 4,0 g
- operating temperature: -20 °C to +60 °C
- packaging: 1 pc, blister



**B15441** 1/-/10/900  
10 42 233 011 GP CR2330

- chemical constitution: lithium
- type: GP CR2354
- voltage: 3 V
- capacity: 560 mAh
- dimensions: 23.0 × 5.4 mm
- weight: 6,9 g
- operating temperature: -20 °C to +60 °C
- packaging: 1 pc, blister



**B15231** 1/-/10/900  
10 42 235 411 CR2354

- chemical constitution: lithium
- type: GP CR2430
- voltage: 3 V
- capacity: 300 mAh
- dimensions: 24.5 × 3.0 mm
- weight: 4,3 g
- operating temperature: -20 °C to +60 °C
- packaging: 1 pc, blister



**B15301** 1/10/100/900  
10 42 243 011 GP CR2430



www.emos.eu

Order Code  
Item Number

Packaging  
Type

- chemical constitution: lithium
- type: GP CR2430
- voltage: 3 V
- capacity: 300 mAh
- dimensions: 24.5 × 3.0 mm
- weight: 4.3 g
- operating temperature: -20 °C to +60 °C
- packaging: 5 pcs, blister



**B1530** 5/100/-/1 000  
10 42 243 015 GP CR2430

- chemical constitution: lithium
- type: GP CR2450
- voltage: 3 V
- capacity: 590 mAh
- dimensions: 24.5 × 5.0 mm
- weight: 6.6 g
- operating temperature: -20 °C to +60 °C
- packaging: 1 pc, blister



**B15851** 1/-/10/600  
10 42 245 011 GP CR2450

- chemical constitution: lithium
- type: GP CR2450
- voltage: 3 V
- capacity: 590 mAh
- dimensions: 24.5 × 5.0 mm
- weight: 6.6 g
- operating temperature: -20 °C to +60 °C
- packaging: 5 pcs, blister



**B1585** 5/-/100/1 000  
10 42 245 015 GP CR2450

- chemical constitution: lithium
- type: GP CR2477
- voltage: 3 V
- capacity: 590 mAh
- dimensions: 24.5 × 7.7 mm
- weight: 6.6 g
- operating temperature: -20 °C to +60 °C
- packaging: 1 pc, blister



**B15771** 1/-/10/600  
10 42 247 711 GP CR2477

- chemical constitution: lithium
- type: GP CR3032
- voltage: 3 V
- capacity: 500 mAh
- dimensions: 30.0 × 3.2 mm
- weight: 6.8 g
- operating temperature: -20 °C to +60 °C
- packaging: 1 pc, blister



**B15331** 1/-/10/600  
10 42 303 211 GP CR3032



www.emos.eu

Order Code  
Item Number

Packaging  
Type

- chemical constitution: lithium
- type: GP CR2025
- voltage: 3 V
- capacity: 165 mAh
- dimensions: 20.0 × 2.5 mm
- weight: 2.5 g
- operating temperature: -20 °C to +60 °C
- packaging: 4 pcs, blister



**B15254** 4/-/40/2 400  
10 42 202 514 GP CR2025

- chemical constitution: lithium
- type: CR2032
- voltage: 3 V
- capacity: 240 mAh
- dimensions: 20.0 × 3.2 mm
- weight: 3.1 g
- operating temperature: -20 °C to +60 °C
- packaging: 4 pcs, blister



**B15324** 4/-/40/2 400  
10 42 203 214 GP CR2032

## GP Special alkaline

- long-lasting performance
- stable operating voltage
- operating temperature from 0 °C to +45 °C
- shelf life up to 3 years



- chemical constitution: alkaline-special
- type: GP 23AF (V23GA, MN21, A23)
- voltage: 12 V
- capacity: 55 mAh (discharge load 20 kOhm)
- dimensions: 10.22 × 28.2 mm
- weight: 7.9 g
- operating temperature: 0 °C to +45 °C
- packaging: 1 pc, blister



**B13001** 1/-/10/720  
10 21 002 311 GP 23AF

- chemical constitution: alkaline-special
- type: GP 23AF (V23GA, MN21, A23)
- voltage: 12 V
- capacity: 55 mAh (discharge load 20 kOhm)
- dimensions: 10.22 × 28.2 mm
- weight: 7.9 g
- operating temperature: 0 °C to +45 °C
- packaging: 5 pcs, blister



**B1300** 5/-/100/1 000  
10 21 002 315 GP 23AF





- chemical constitution: alkaline-special
- type: GP 27A (A27, MN27, A90)
- voltage: 12 V
- capacity: 20 mAh (discharge load 20 kOhm)
- dimensions: 8.0 × 28.2 mm
- weight: 4.4 g
- operating temperature: 0 °C to +45 °C
- packaging: 1 pc, blister



**B13011** 1/10/-/600  
10 21 002 711 GP 27AF

- chemical constitution: alkaline-special
- type: GP 27A (A27, MN27, A90)
- voltage: 12 V
- capacity: 20 mAh (discharge load 20 kOhm)
- dimensions: 8.0 × 28.2 mm
- weight: 4.4 g
- operating temperature: 0 °C to +45 °C
- packaging: 5 pcs, blister



**B1301** 5/-/100/1 000  
10 21 002 715 GP 27AF

- chemical constitution: alkaline-special
- type: GP 11AF
- voltage: 6 V
- capacity: 38 mAh (discharge load 10 kOhm)
- dimensions: 10.22 × 16.5 mm
- weight: 4.0 g
- operating temperature: 0 °C to +45 °C
- packaging: 1 pc, blister



**B13021** 1/-/10/720  
10 21 001 111 GP 11AF

- chemical constitution: alkaline-special
- type: GP 11AF
- voltage: 6 V
- capacity: 38 mAh (discharge load 10 kOhm)
- dimensions: 10.22 × 16.5 mm
- weight: 4.0 g
- operating temperature: 0 °C to +45 °C
- packaging: 5 pcs, blister



**B1302** 5/-/100/1 000  
10 21 001 115 GP 11AF

- chemical constitution: alkaline-special
- type: GP 476AF (4LR44, PX28A, V4034PX)
- voltage: 6 V
- capacity: 105 mAh (discharge load 6 kOhm)
- dimensions: 13.0 × 25.2 mm
- weight: 10 g
- operating temperature: 0 °C to +45 °C
- packaging: 1 pc, blister



**B1303** 1/-/10/600  
10 21 047 612 GP 476AF



www.emos.eu

Order Code  
Item Number

Packaging  
Type

- chemical constitution: alkaline-special
- type: GP 910A (N, LR1)
- voltage: 1.5 V
- capacity: 885 mAh (discharge load 20 kOhm)
- dimensions: 12.0 × 30.2 mm
- weight: 9 g
- operating temperature: 0 °C to +45 °C
- packaging: 2 pcs, blister



**B1305**

2/-/20/160

10 21 091 012

GP 910A

- chemical constitution: alkaline-special
- type: GP 25A (AAAA, LR61, LR8, MN2500)
- voltage: 1.5 V
- capacity: 525 mAh (discharge load 42 kOhm)
- dimensions: 8.3 × 42.5 mm
- weight: 6.8 g
- operating temperature: 0 °C to +45 °C
- packaging: 2 pcs, blister



**B1306**

2/-/20/160

10 21 002 512

GP 25A

- chemical constitution: alkaline-special
- type: GP 29A (A29, 32A, A32, L822)
- voltage: 9 V
- dimensions: 8.0 × 21.9 mm
- weight: 3.5 g
- operating temperature: 0 °C to +45 °C
- packaging: 1 pc, blister



**B13951**

1/-/10/600

10 21 002 911

GP 29AF

## GP Alkaline button



- long-lasting performance
- voltage of 1.5 V
- operating temperature 0 °C to +45 °C
- shelf life up to 3 years



- chemical constitution: alkaline
- type: GP A76F (AG13, LR44, LR1154, V13GA, PX76A)
- voltage: 1.5 V
- capacity: 110 mAh (discharge load 1.6 kOhm)
- dimensions: 11.6 × 5.4 mm
- weight: 1.7 g
- operating temperature: 0 °C to +45 °C
- packaging: 1 pc, blister



**B13762**

1/-/10/750

10 41 007 611

GP A76F



- chemical constitution: alkaline
- type: GP A76F (AG13, LR44, LR1154, V13GA, PX76A)
- voltage: 1.5 V
- capacity: 110 mAh (discharge load 1.6 kOhm)
- dimensions: 11.6 × 5.4 mm
- weight: 1.7 g
- operating temperature: 0 °C to +45 °C
- packaging: 5 pcs, blister

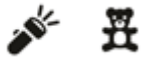

**B1376** 5/-/100/1 000  
10 41 007 615 GP A76F

- chemical constitution: alkaline
- type: GP 186F (AG12, LR43, LR1142, V12GA)
- voltage: 1.5 V
- capacity: 70 mAh (discharge load 1.6 kOhm)
- dimensions: 11.6 × 4.2 mm
- weight: 1.4 g
- operating temperature: 0 °C to +45 °C
- packaging: 1 pc, blister



**B13861** 1/-/10/750  
10 41 018 611 GP 186F

- chemical constitution: alkaline
- type: GP 189F (AG10, LR54, LR1130, V10GA)
- voltage: 1.5 V
- capacity: 44 mAh (discharge load 3.9 kOhm)
- dimensions: 11.6 × 3.05 mm
- weight: 1.0 g
- operating temperature: 0 °C to +45 °C
- packaging: 1 pc, blister



**B13892** 1/-/10/750  
10 41 018 911 GP 189F

- chemical constitution: alkaline
- type: GP 189F (AG10, LR54, LR1130, V10GA)
- voltage: 1.5 V
- capacity: 44 mAh (discharge load 3.9 kOhm)
- dimensions: 11.6 × 3.05 mm
- weight: 1.0 g
- operating temperature: 0 °C to +45 °C
- packaging: 10 pcs, blister

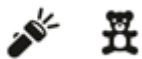

**B1389** 10/-/250/5 000  
10 41 018 910 GP 189F

- chemical constitution: alkaline
- type: GP 192F (LR41, V3GA)
- voltage: 1.5 V
- capacity: 24 mAh (discharge load 30 kOhm)
- dimensions: 7.9 × 3.6 mm
- weight: 0.5 g
- operating temperature: 0 °C to +45 °C
- packaging: 1 pc, blister



**B13921** 1/-/10/750  
10 41 019 211 GP 192F



www.emos.eu

Order Code  
Item Number

Packaging  
Type

- chemical constitution: alkaline
- type: GP 192F (LR41, V3GA)
- voltage: 1.5 V
- capacity: 24 mAh (discharge load 6.2 kOhm)
- dimensions: 7.9 × 3.6 mm
- weight: 0.5 g
- operating temperature: 0 °C to +45 °C
- packaging: 5 pcs, blister



**B13925** 5/-/100/1 000  
10 41 019 205 GP 192F

- chemical constitution: alkaline
- type: GP PX625A (LR9, V625U)
- voltage: 1.5 V
- capacity: 190 mAh (discharge load 600 Ohm)
- dimensions: 15.6 × 5.95 mm
- weight: 2.9 g
- operating temperature: 0 °C to +45 °C
- packaging: 1 pc, blister



**B1325** 1/10/-/750  
10 41 062 511 GP 625AF

- chemical constitution: alkaline
- type: GP A76F (AG13, LR44, LR1154, V13GA, PX76A)
- voltage: 1.5 V
- capacity: 110 mAh (discharge load 1.6 kOhm)
- dimensions: 11.6 × 5.4 mm
- weight: 1.7 g
- operating temperature: 0 °C to +45 °C
- packaging: 2 pcs, blister



**B13763** 2/-/20/1 500  
10 41 007 601 GP A76F

## GP Silver oxide



- long-lasting performance
- voltage of 1.55 V
- operating temperature from 0 °C to +45 °C
- shelf life up to 3 years



- chemical constitution: silver oxide
- type: GP 357F (SR44, SR1154, V357)
- voltage: 1.55 V
- capacity: 165 mAh (discharge load 3.0 kOhm)
- dimensions: 11.6 × 5.4 mm
- operating temperature: 0 °C to +45 °C
- packaging: 1 pc, blister



**B3357F1** 1/-/10/750  
10 43 035 721 GP 357F





- chemical constitution: silver oxide
- type: GP 377F (SR66, SR626, V377)
- voltage: 1.55 V
- capacity: 24 mAh (discharge load 33 kOhm)
- dimensions: 6.8 × 2.6 mm
- weight: 0.4 g
- operating temperature: 0 °C to +45 °C
- packaging: 1 pc, blister



**B3377F1**

1/-/10/750

10 43 037 721

GP 377F

- chemical constitution: silver oxide
- type: GP 364F (SR60, SR621, V364)
- voltage: 1.55 V
- capacity: 18 mAh (discharge load 47 kOhm)
- dimensions: 6.8 × 2.15 mm
- weight: 0.36 g
- operating temperature: 0 °C to +45 °C
- packaging: 1 pc, blister



**B3364F1**

1/10/-/750

10 43 036 431

- chemical constitution: silver oxide
- type: GP 389F (SR54, SR1130, V389)
- voltage: 1.55 V
- capacity: 70 mAh (discharge load 3 kOhm)
- dimensions: 11.6 × 3.05 mm
- operating temperature: 0 °C to +45 °C
- packaging: 1 pc, blister



**B3389F1**

1/10/-/750

10 43 038 921

- chemical constitution: silver oxide
- type: GP 392F (SR41, SR736, V392)
- voltage: 1.55 V
- capacity: 42 mAh (discharge load 3.0 kOhm)
- dimensions: 7.9 × 3.6 mm
- operating temperature: 0 °C to +45 °C
- packaging: 1 pc, blister



**B3392F1**

1/10/-/750

10 43 039 221

# GP Zinc air



- long lasting power +50 %
- consistent sound quality
- ideal also for latest wireless hearing aid devices
- longer battery tab for easy insertion into hearing aids
- safety and quality assurance
- storage time 4 years
- made in UK



- chemical constitution: zinc-air
- type: GP ZA10 (7005ZD, PR70)
- voltage: 1.45 V
- capacity: 90 mAh (discharge load 1.5 kOhm)
- dimensions: 5.8 × 3.6 mm
- weight: 0.3 g
- operating temperature: -10 °C to +50 °C
- packaging: 6 pcs, blister



**B3510** 6/60/300/3 000

10 44 001 016 GP ZA10

- chemical constitution: zinc-air
- type: GP ZA13 (7000ZD, PR48)
- voltage: 1.45 V
- capacity: 290 mAh (discharge load 625 Ohm)
- dimensions: 7.9 × 5.4 mm
- weight: 0.8 g
- operating temperature: -10 °C to +50 °C
- packaging: 6 pcs, blister



**B3513** 6/60/300/3 000

10 44 001 316 GP ZA13

- chemical constitution: zinc-air
- type: GP ZA312 (7002ZD, PR41)
- voltage: 1.45 V
- capacity: 170 mAh (discharge load 1.0 kOhm)
- dimensions: 7.9 × 3.6 mm
- weight: 0.5 g
- operating temperature: -10 °C to +50 °C
- packaging: 6 pcs, blister



**B3512** 6/60/300/3 000

10 44 031 216 GP ZA312

- chemical constitution: zinc-air
- type: GP ZA675 (7003ZD, PR44)
- voltage: 1.45 V
- capacity: 620 mAh (discharge load 300 Ohm)
- dimensions: 11.6 × 5.4 mm
- weight: 1.8 g
- operating temperature: -10 °C to +50 °C
- packaging: 6 pcs, blister



**B3575** 6/60/300/3 000

10 44 067 516 GP ZA675

# GP Batteries

## GP Consumer batteries

### GP Rechargeable

#### GP ReCyko Pro



- high-performance rechargeable batteries with long run time
- at least 1 500 recharge cycles \*
- extremely low self-discharge effect \*
- charged to 70 % even after 5 years of no use \*
- precharged from production – for immediate use
- friendly to the environment and your wallet
- \* (valid for Professional line)



- chemical constitution: NiMH
- type: HR03 (AAA battery)
- voltage: 1.2 V
- capacity: 800 mAh
- number of charging cycles: more than 1 500
- dimensions: 10.5 × 44.5 mm
- weight: 14 g
- operating temperature: -20 °C to +50 °C
- packaging: 4 pcs, small paper box



**B26184**

4/-/40/400

10 32 124 080

85AAHCBP

- chemical constitution: NiMH
- type: HR03 (AAA battery)
- voltage: 1.2 V
- capacity: 800 mAh
- number of charging cycles: more than 1 500
- dimensions: 10.5 × 44.5 mm
- weight: 14 g
- operating temperature: -20 °C to +50 °C
- packaging: 6 pcs, small paper box



**B2618V**

6/-/60/720

10 32 126 080

85AAHCBP

- chemical constitution: NiMH
- type: HR6 (AA battery)
- voltage: 1.2 V
- capacity: 2 000 mAh
- number of charging cycles: more than 1 500
- dimensions: 14.5 × 50.5 mm
- weight: 30 g
- operating temperature: -20 °C to +50 °C
- packaging: 4 pcs, small paper box



**B26204**

4/-/40/400

10 32 224 200

210AAHCBP



www.emos.eu

Order Code  
Item Number

Packaging  
Type

- chemical constitution: NiMH
- type: HR6 (AA battery)
- voltage: 1.2 V
- capacity: 2 000 mAh
- number of charging cycles: more than 500
- dimensions: 14.5 × 50.5 mm
- weight: 30 g
- operating temperature: -20 °C to +50 °C
- packaging: 4 pcs, small paper box



**B2629**

4/-/40/400

10 32 224 201

210AAHCF

- chemical constitution: NiMH
- type: HR6 (AA battery)
- voltage: 1.2 V
- capacity: 2 000 mAh
- number of charging cycles: more than 1 500
- dimensions: 14.5 × 50.5 mm
- weight: 30 g
- operating temperature: -20 °C to +50 °C
- packaging: 6 pcs, small paper box



**B2620V**

6/-/60/360

10 32 226 200

210AAHCBP

## GP ReCyko



- wide range of capacities and retail packages
- one of the longest run times available on the market
- low self-discharge – charged to 70 % after a year of no use
- precharged from production – for immediate use
- friendly to the environment and your wallet



- chemical constitution: NiMH
- type: HR03 (AAA battery)
- voltage: 1.2 V
- capacity: 650 mAh
- number of charging cycles: more than 1 000
- dimensions: 10.5 × 44.5 mm
- weight: 12 g
- operating temperature: -20 °C to +50 °C
- packaging: 2 pcs, small paper box



**B25162**

2/-/20/200

10 32 122 062

65AAAHCE

- chemical constitution: NiMH
- type: HR03 (AAA battery)
- voltage: 1.2 V
- capacity: 850 mAh
- number of charging cycles: more than 500
- dimensions: 10.5 × 44.5 mm
- weight: 14.5 g
- operating temperature: -20 °C to +50 °C
- packaging: 2 pcs, small paper box



**B25182**

2/-/20/200

10 32 122 080

85AAAHCE





- chemical constitution: NiMH
- type: HR03 (AAA battery)
- voltage: 1.2 V
- capacity: 950 mAh
- number of charging cycles: more than 500
- dimensions: 10.5 × 44.5 mm
- weight: 15 g
- operating temperature: -20 °C to +50 °C
- packaging: 2 pcs, small paper box



**B25112** 2/-/20/200  
10 32 122 090 100AAHCE

- chemical constitution: NiMH
- type: HR03 (AAA battery)
- voltage: 1.2 V
- capacity: 850 mAh
- number of charging cycles: more than 500
- dimensions: 14.5 × 50.5 mm
- weight: 14.5 g
- operating temperature: -20 °C to +50 °C
- packaging: 4 pcs, small paper box



**B25184** 4/-/40/400  
10 32 124 081 85AAHCE

- chemical constitution: NiMH
- type: HR03 (AAA battery)
- voltage: 1.2 V
- capacity: 950 mAh
- number of charging cycles: more than 500
- dimensions: 10.5 × 44.5 mm
- weight: 15 g
- operating temperature: -20 °C to +50 °C
- packaging: 4 pcs, small paper box



**B25114** 4/-/40/400  
10 32 124 090 100AAHCE

- chemical constitution: NiMH
- type: HR03 (AAA battery)
- voltage: 1.2 V
- capacity: 950 mAh
- number of charging cycles: more than 500
- dimensions: 10.5 × 44.5 mm
- weight: 15 g
- operating temperature: -20 °C to +50 °C
- packaging: 6 pcs, small paper box



**B2511V** 6/-/60/720  
10 32 126 090 100AAHCE

- chemical constitution: NiMH
- type: HR6 (AA battery)
- voltage: 1.2 V
- capacity: 1300 mAh
- number of charging cycles: more than 500
- dimensions: 14.5 × 50.5 mm
- weight: 23 g
- operating temperature: -20 °C to +50 °C
- packaging: 2 pcs, small paper box



**B25232** 2/-/20/200  
10 32 222 131 130AAHCE



www.emos.eu

Order Code  
Item Number

Packaging  
Type

- chemical constitution: NiMH
- type: HR6 (AA battery)
- voltage: 1.2 V
- capacity: 2 100 mAh
- number of charging cycles: more than 500
- dimensions: 14.5 × 50.5 mm
- weight: 27 g
- operating temperature: -20 °C to +50 °C
- packaging: 2 pcs, small paper box



**B25212**

2/-/20/200

10 32 222 211

210AAHCE

- chemical constitution: NiMH
- type: HR6 (AA battery)
- voltage: 1.2 V
- capacity: 2 600 mAh
- number of charging cycles: more than 300
- dimensions: 14.5 × 50.5 mm
- weight: 31 g
- operating temperature: -20 °C to +50 °C
- packaging: 2 pcs, small paper box



**B25272**

2/-/20/200

10 32 222 260

270AAHCE

- chemical constitution: NiMH
- type: HR6 (AA battery)
- voltage: 1.2 V
- capacity: 2 100 mAh
- number of charging cycles: more than 500
- dimensions: 14.5 × 50.5 mm
- weight: 27 g
- operating temperature: -20 °C to +50 °C
- packaging: 4 pcs, small paper box



**B25214**

4/-/40/400

10 32 224 210

210AAHCE

- chemical constitution: NiMH
- type: HR6 (AA battery)
- voltage: 1.2 V
- capacity: 2 600 mAh
- number of charging cycles: up to 300
- dimensions: 14.5 × 50.5 mm
- weight: 31 g
- operating temperature: -20 °C to +50 °C
- packaging: 4 pcs, small paper box



**B25274**

4/-/40/400

10 32 224 260

270AAHCE

- chemical constitution: NiMH
- type: HR6 (AA battery)
- voltage: 1.2 V
- capacity: 2 100 mAh
- number of charging cycles: more than 500
- dimensions: 14.5 × 50.5 mm
- weight: 27 g
- operating temperature: -20 °C to +50 °C
- packaging: 6 pcs, small paper box



**B2521V**

6/-/60/360

10 32 226 212

210AAHCF



www.emos.eu

Order Code  
Item Number

Packaging  
Type

- chemical constitution: NiMH
- type: HR6 (AA battery)
- voltage: 1.2 V
- capacity: 2 600 mAh
- number of charging cycles: up to 300
- dimensions: 14.5 × 50.5 mm
- weight: 31 g
- operating temperature: -20 °C to +50 °C
- packaging: 6 pcs, small paper box



**B2527V** 6/-/60/360  
10 32 226 260 270AAHCE

- chemical constitution: NiMH
- type: HR14 (C battery)
- voltage: 1.2 V
- capacity: 3 000 mAh
- number of charging cycles: more than 1 000
- dimensions: 26.2 × 50.0 mm
- weight: 60 g
- operating temperature: -20 °C to +50 °C
- packaging: 2 pcs, small paper box



**B2533** 2/-/12/120  
10 32 322 301 300CHC

- chemical constitution: NiMH
- type: HR20 (D battery)
- voltage: 1.2 V
- capacity: 3 000 mAh
- number of charging cycles: more than 1 000
- dimensions: 34.2 × 61.5 mm
- weight: 70 g
- operating temperature: -20 °C to +50 °C
- packaging: 2 pcs, small paper box



**B2543** 2/-/12/72  
10 32 422 300 300DHC

- chemical constitution: NiMH
- type: 6HR61 9 V (1604)
- voltage: 8.4 V
- capacity: 200 mAh
- number of charging cycles: more than 500
- dimensions: 26.5 × 15.7 × 48.5 mm
- weight: 42.5 g
- operating temperature: -20 °C to +50 °C
- packaging: 1 pc, small paper box



**B2552** 1/-/10/100  
10 32 521 021 20R8H

- chemical constitution: NiMH
- type: HR6 (AA battery)
- voltage: 1.2 V
- capacity: 1 700 mAh
- number of charging cycles: more than 700
- dimensions: 14.5 × 50.5 mm
- weight: 26.2 g
- operating temperature: -20 °C to +50 °C
- packaging: 4 pcs, small paper box



**B24294** 4/-/40/400  
10 33 224 170 170AAHCV

# Raver Batteries

## Raver Lithium cylindrical



- suitable for digital cameras and flashes
- electronic toys, hobby models, MP3 players, PDAs and GPS
- also meet the requirements of healthcare tools and devices
- ideal for use in extreme temperatures of -40 °C to +60 °C
- shelf life up to 10 years



- chemical constitution: lithium
- type: FR03 (AAA battery)
- voltage: 1.5 V
- dimensions: 10.5 × 44.5 mm
- weight: 7.2 g
- operating temperature: -40 °C to +60 °C
- packaging: 2 pcs, blister



**B7811**

2/-/28/280

13 21 112 000

RLT FR03-B2

- chemical constitution: lithium
- type: FR6 (AA battery)
- voltage: 1.5 V
- dimensions: 14.5 × 50.5 mm
- weight: 15.5 g
- operating temperature: -40 °C to +60 °C
- packaging: 2 pcs, blister



**B7821**

2/-/20/200

13 21 212 000

RLT FR6-B2



# Raver Batteries

## Raver Alkaline

### Raver Ultra



- top performance in devices with low long-term consumption
- up to 7x more energy than standard zinc-carbon batteries
- operating temperature from -20 °C to +60 °C
- shelf life up to 7 years



- chemical constitution: alkaline
- type: LR03 (AAA battery)
- voltage: 1.5 V
- dimensions: 10.5 × 44.5 mm
- weight: 11.5 g
- operating temperature: -20 °C to +60 °C
- packaging: 4 pcs, blister



**B7911**

4/-/40/320

13 20 114 000

RUA LR03-B4

- chemical constitution: alkaline
- type: LR03 (AAA battery)
- voltage: 1.5 V
- dimensions: 10.5 × 44.5 mm
- weight: 11.5 g
- operating temperature: -20 °C to +60 °C
- packaging: 8 pcs, shrink



**B79118**

8/-/96/960

13 20 118 000

RUA LR03-S8

- chemical constitution: alkaline
- type: LR6 (AA battery)
- voltage: 1.5 V
- dimensions: 14.5 × 50.5 mm
- weight: 23,8 g
- operating temperature: -20 °C to +60 °C
- packaging: 4 pcs, blister



**B7921**

4/-/40/320

13 20 214 000

RUA LR6-B4

- chemical constitution: alkaline
- type: LR6 (AA battery)
- voltage: 1.5 V
- dimensions: 14.5 × 50.5 mm
- weight: 23,8 g
- operating temperature: -20 °C to +60 °C
- packaging: 8 pcs, shrink



**B79218** 8/-/96/960  
13 20 218 000 RUA LR6-S8

## Raver Batteries

### Raver Rechargeable



- RAVER SOLAR – excellent choice for solar garden lights
- it often only takes a new battery to get a light to work
- rechargeable batteries save both money and the environment
- also usable for other undemanding devices
- operating temperature from -20 °C to +50 °C



- chemical constitution: NiMH
- type: HR03 (AAA battery)
- voltage: 1.2 V
- capacity: 400 mAh
- number of charging cycles: more than 500
- dimensions: 10.5 × 44.5 mm
- weight: 9 g
- operating temperature: -20 °C to +50 °C
- packaging: 2 pcs, blister



**B7414** 2/-/32/384  
13 32 112 040 RAVER SOLAR  
AAA

- chemical constitution: NiMH
- type: HR6 (AA battery)
- voltage: 1.2 V
- capacity: 600 mAh
- number of charging cycles: more than 500
- dimensions: 14.5 × 50.5 mm
- weight: 15 g
- operating temperature: -20 °C to +50 °C
- packaging: 2 pcs, blister



**B7426** 2/-/24/288  
13 32 212 030 RAVER SOLAR AA

# Raver Batteries

## Raver Other batteries

### Raver Lithium button



- suitable for devices requiring a stable supply of power
- e.g. watches, calculators, alarms, manometers, etc.
- long service life
- operating temperature from -10 °C to +60 °C
- shelf life up to 10 years



- chemical constitution: lithium
- type: CR2016
- voltage: 3 V
- capacity: 75 mAh (discharge load 30 kOhm)
- dimensions: 20.0 × 1.6 mm
- weight: 1.7 g
- operating temperature: -10 °C to +60 °C
- packaging: 5 pcs, blister



**B7316**

5/-/150/-/1 800

13 26 021 605

RAVER CR2016

- chemical constitution: lithium
- type: CR2032
- voltage: 3 V
- capacity: 220 mAh (discharge load 15 kOhm)
- dimensions: 20.0 × 3.2 mm
- weight: 3.1 g
- operating temperature: -10 °C to +60 °C
- packaging: 5 pcs, blister



**B7332**

5/-/150/1 800

13 26 023 205

RAVER CR2032

# Batteries EMOS, lead acid battery

## Lead acid batteries

- maintenance-free, valve-controlled industrial lead accumulators
- for low-cost powering of devices
- hermetically sealed lead AGM accumulators
- wide range of uses – fire alarms, communication devices, UPS
- optimal service life 5 years

**B9651** 1/-/-/20  
12 01 000 500 OT1.3-6 (E613)



8 595025 340818



voltage: 6 V = capacity: 1.3 Ah = weight: 0.3 kg = terminal: faston 4.7 mm = optimal lifetime: 5 years = dimensions: 97 × 24 × 51 mm = packaging: 1 pc

**B9641** 1/-/-/20  
12 01 000 100 OT4-6(E640)



8 595025 318732



for lanterns: 3810 (P2301), 3810 LED (P2304), 3810 LED EXPERT (P2305), 3810 10W + COB (P2308) = chemical constitution: Pb = voltage: 6 V = capacity: 4 Ah = dimensions: 70 × 47 × 101 mm = packaging: 1 pc

**B9659** 1/-/-/16  
12 01 000 520 OT7-6 (E670)



8 595025 353474



voltage: 6 V = capacity: 7 Ah = weight: 1 kg = terminal: faston 4.7 mm = optimal lifetime: 5 years = dimensions: 151 × 34 × 94 mm = packaging: 1 pc

**B9682** 1/-/-/10  
12 01 003 500 OT12-6 (E-6120)



8 592920 005668



voltage: 6 V = capacity: 12 Ah = weight: 1.8 kg = terminal: faston 4.7 mm = optimal lifetime: 5 years = dimensions: 151 × 51 × 94 mm = packaging: 1 pc

**B9652** 1/-/-/20  
12 01 000 600 OT1.3-12 (E1213; E1.3-12)



8 595025 340825



voltage: 12 V = capacity: 1.3 Ah = weight: 0.5 kg = terminal: faston 4.7 mm = optimal lifetime: 5 years = dimensions: 97 × 45 × 53 mm = packaging: 1 pc

**B9672** 1/-/-/20  
12 01 002 600 OT2.2-12 (E1222)



8 592920 004159





voltage: 12 V = capacity: 2.2 Ah = weight: 0.95 kg = terminal: faston 4.7 mm = optimal lifetime: 5 years = dimensions: 178 × 35 × 61 mm = packaging: 1 pc





**B9653** 1/-/-/10  
12 01 000 700 OT4.5-12 (E1245)



voltage: 12 V = capacity: 4.5 Ah = weight: 1.46 kg = terminal: faston 4.7 mm = optimal lifetime: 5 years = dimensions: 91 × 71 × 105 mm = packaging: 1 pc

**B9679** 1/-/-/10  
12 01 003 300 OT5-12 (E1250)





voltage: 12 V = capacity: 5 Ah = weight: 1.65 kg = terminal: faston 6.3 mm = optimal lifetime: 5 years = dimensions: 91 × 71 × 105 mm = packaging: 1 pc

**B9691** 1/-/-/10  
12 01 004 300 OT7-12 (E1270)



voltage: 12 V = capacity: 7 Ah = weight: 2.05 kg = terminal: faston 4.7 mm = optimal lifetime: 5 years = dimensions: 151 × 65 × 94 mm = packaging: 1 pc

**B9654** 1/-/-/10  
12 01 000 800 OT7.2-12 (E1272; E7.2-12)



voltage: 12 V = capacity: 7.2 Ah = weight: 2.2 kg = terminal: faston 4.7 mm = optimal lifetime: 5 years = dimensions: 151 × 65 × 94 mm = packaging: 1 pc

**B9674** 1/-/-/10  
12 01 002 800 OT 7.2-12(OT 7.2-12 T2)



voltage: 12 V = capacity: 7.2 Ah = weight: 2.2 kg = terminal: faston 6.3 mm = optimal lifetime: 5 years = dimensions: 151 × 65 × 94 mm = packaging: 1 pc

**B9675** 1/-/-/10  
12 01 002 900 OT9-12 (E1290)



voltage: 12 V = capacity: 9 Ah = weight: 2.42 kg = terminal: faston 6.3 mm = optimal lifetime: 5 years = dimensions: 151 × 65 × 94 mm = packaging: 1 pc

**B9656** 1/-/-/4  
12 01 000 850 OT12-12 (E12120; E12-12)

voltage: 12 V = capacity: 12 Ah = weight: 3.3 kg = terminal: faston 6.3 mm = optimal lifetime: 5 years = dimensions: 151 × 98 × 96 mm = packaging: 1 pc

**B9656V** 1/-/-/2  
12 01 004 800 6-DZM-12



voltage: 12 V = capacity: 15 Ah/20 hrs (14 Ah/10 hrs, 12 Ah/2 hrs) = weight: 4.25 kg = terminal: faston 6.3 mm = optimal lifetime: 4 years for cyclic operation (approx. 1 200 cycles for 30 % D.O.D = discharge depth) = dimensions: 150 × 100 × 102 mm = packaging: 1 pc

**B9655** 1/-/-/4  
12 01 000 900 OT17-12 (E12180; OT 18-12)



voltage: 12 V = capacity: 18 Ah = weight: 4.88 kg = terminal: 12 × 12 × 2 mm = optimal lifetime: 5 years = dimensions: 181 × 77 × 167 mm = packaging: 1 pc

**B9683** 1/-/-/2  
12 01 003 600 OT26-12/W; (E12260)

voltage: 12 V = capacity: 26 Ah = weight: 8.05 kg = terminal: 14 × 12 × 2 mm = optimal lifetime: 5 years = dimensions: 175 × 165 × 125 mm = packaging: 1 pc



www.emos.eu

Order Code  
Item Number

Packaging  
Type

**B9684**

1/-/-1

12 01 003 700

OT40-12 (E1240;  
E40-12)



8 592920 006412

voltage: 12 V = capacity: 40 Ah = weight: 13.05 kg = terminal: T1 – M6 = optimal  
lifetime: 5 years = dimensions: 196 × 166 × 175 mm = packaging: 1 pc

**B9685**

1/-/-1

12 01 003 800

OT65-12 (E-  
12650)



8 592920 006436

voltage: 12 V = capacity: 65 Ah = weight: 20.65 kg = terminal: T2 – M8 = optimal  
lifetime: 5 years = dimensions: 350 × 166 × 175 mm = packaging: 1 pc

# Battery chargers, powerbanks, USB chargers



## Battery chargers

### Charge 10



- thanks to the fast charging technology, it reliably charges the batteries in just 10 minutes
- will please with overheating protection or ECO mode for gentle charging of NiMH batteries
- it also has fully automatic intelligent charging and silent operation
- the charger includes 4 environmentally friendly AA batteries that last more than 700 charging cycles

- type of charger: intelligent
- charger design: separated AC cord
- power source: 100-240 V AC
- size of the charged cells: AAA, AA
- number of cells inside the package: 4
- type of cells inside the package: AA ReCyko Charge
- charging time of the enclosed cells: 00:10
- number of charging channels: 4
- number of batteries charged: 1 to 4
- charging current for AA: 10 000 mA
- charging current for AAA: 1 500 mA
- charging time AA 2 700 mAh: 0:30
- charging time AAA 1 000 mAh: 0:45
- packaging: 1 pc, small paper box



**B56499**

1/-/6/12

16 04 849 120

S491

- chemical constitution: NiMH
- type: HR6 (AA battery)
- voltage: 1.2 V
- capacity: 1 700 mAh
- number of charging cycles: more than 700
- dimensions: 14.5 × 50.5 mm
- weight: 26.2 g
- operating temperature: -20 °C to +50 °C
- packaging: 4 pcs, small paper box



**B24294**

4/-/40/400

10 33 224 170

170AAHCV

# GP Battery chargers



- unique new design concept of NiMH battery chargers
- USB power supply and small size allow you to charge anytime, anywhere
- even basic models offer quick and smart charging
- high-quality GP rechargeable batteries and micro USB cable included
- "Pro" model with LED screen and advanced features



auto on/off



smart diagnostics



charge everywhere

- type of charger: intelligent
- charger design: USB
- power source: USB 5 V/1 A
- size of the charged cells: AAA, AA
- number of cells inside the package: 4
- type of cells inside the package: AA ReCyko 2 700
- charging time of the enclosed cells: 2:45 - 5:30
- number of charging channels: 4
- number of batteries charged: 1 to 4

- charging current for AA: 1 100-550 mA
- charging current for AAA: 730-370 mA
- charging time AA 2 700 mAh: 2:45 - 5:30
- charging time AAA 1 000 mAh: 1:30 - 3:30
- packaging: 1 pc, small paper box



4 891199 195075

**B53457**

1/-/6/12

16 04 845 112

M451

- type of charger: intelligent
- charger design: USB
- power source: USB 5 V/1 A
- size of the charged cells: AAA, AA
- number of cells inside the package: 4
- type of cells inside the package: AA ReCyko Pro
- charging time of the enclosed cells: 2:00 - 4:00
- number of charging channels: 4
- number of batteries charged: 1 to 4

- charging current for AA: 1 100-550 mA
- charging current for AAA: 730-370 mA
- charging time AA 2 700 mAh: 2:45 - 5:30
- charging time AAA 1 000 mAh: 1:30 - 3:30
- packaging: 1 pc, small paper box



4 891199 198335

**B53455**

1/-/6/12

16 04 845 111

M451

- type of charger: intelligent
- charger design: USB
- power source: USB 5 V/1 A
- size of the charged cells: AAA, AA
- number of charging channels: 4
- number of batteries charged: 1 to 4
- charging current for AA: 1 100-550 mA
- charging current for AAA: 730-370 mA
- charging time AA 2 700 mAh: 2:45 - 5:30

- charging time AAA 1 000 mAh: 1:30 - 3:30
- packaging: 1 pc, small paper box



4 891199 198304

**B53450**

1/-/6/12

16 04 845 110

M451

- type of charger: intelligent
- charger design: USB
- power source: USB 5 V/1 A
- size of the charged cells: AAA, AA
- number of cells inside the package: 2
- type of cells inside the package: AA ReCyko 2 100
- charging time of the enclosed cells: 8:00
- number of charging channels: 1
- number of batteries charged: 2

- charging current for AA: 300 mA
- charging current for AAA: 300 mA
- charging time AA 2 700 mAh: 10:00
- charging time AAA 1 000 mAh: 4:00
- packaging: 1 pc, small paper box



4 891199 192890

**B51214**

1/-/-/12

16 04 821 110

E211



- type of charger: intelligent
- charger design: USB
- power source: USB 5 V/1 A
- size of the charged cells: AAA, AA
- number of cells inside the package: 2
- type of cells inside the package: AA ReCyko 2 100
- charging time of the enclosed cells: 8:00
- number of charging channels: 1
- number of batteries charged: 2

- charging current for AA: 300 mA
- charging current for AAA: 300 mA
- charging time AA 2 700 mAh: 10:00
- charging time AAA 1 000 mAh: 4:00
- packaging: 1 pc, small paper box



**B50224** 1/-/-/12  
16 04 822 110 E221

- type of charger: intelligent
- charger design: USB
- power source: USB 5 V/1 A
- size of the charged cells: AAA, AA
- number of cells inside the package: 4
- type of cells inside the package: AA Recharge 1300,
- charging time of the enclosed cells: 2:00 - 4:00
- number of charging channels: 2
- number of batteries charged: 2 or 4

- charging current for AA: 770 mA/380 mA
- charging current for AAA: 300 mA
- charging time AA 2 700 mAh: 4:00 - 8:00
- charging time AAA 1 000 mAh: 4:00
- packaging: 1 pc, small paper box



**B50449** 1/-/-/12  
16 04 844 100 B441

- type of charger: intelligent
- charger design: USB
- power source: USB 5 V/1 A
- size of the charged cells: AAA, AA
- number of cells inside the package: 4
- type of cells inside the package: AA ReCyko 2 100
- charging time of the enclosed cells: 3:00/6:00
- number of charging channels: 2
- number of batteries charged: 2 or 4

- charging current for AA: 770 mA/380 mA
- charging current for AAA: 300 mA
- charging time AA 2 700 mAh: 4:00 - 8:00
- charging time AAA 1 000 mAh: 2:30 - 3:30
- packaging: 1 pc, small paper box



**B50444** 1/-/-/12  
16 04 844 110 B441

- type of charger: intelligent
- charger design: USB
- power source: USB 5 V/1 A
- size of the charged cells: AAA, AA
- number of cells inside the package: 4
- type of cells inside the package: AA ReCyko Pro
- charging time of the enclosed cells: 2:45 - 5:30
- number of charging channels: 4
- number of batteries charged: 1 to 4

- charging current for AA: 1 100-550 mA
- charging current for AAA: 730-370 mA
- charging time AA 2 700 mAh: 2:45 - 5:30
- charging time AAA 1 000 mAh: 1:30 - 3:30
- packaging: 1 pc, small paper box



**B50457** 1/-/6/12  
16 04 845 210 M452

- type of charger: intelligent
- charger design: USB
- power source: USB 5 V/2 A
- size of the charged cells: AAA, AA
- special features: capacity check, docking station
- number of cells inside the package: 4
- type of cells inside the package: AA ReCyko Pro
- charging time of the enclosed cells: 1:20 - 2:40
- number of charging channels: 4

- number of batteries charged: 1 to 4
- charging current for AA: 1 730 mA/ 870 mA
- charging current for AAA: 700 mA/350 mA
- charging time AA 2 700 mAh: 1:45/3:30
- charging time AAA 1 000 mAh: 1:30 - 3:15
- packaging: 1 pc, small paper box



**B50460D** 1/-/6/12  
16 04 846 114 P461



www.emos.eu

Order Code  
Item Number

Packaging  
Type

- type of charger: intelligent
- charger design: USB
- power source: USB 5 V/1 A
- size of the charged cells: AAA, AA
- number of cells inside the package: 8
- type of cells inside the package: AA ReCyko 2 100, A
- charging time of the enclosed cells: 9:00
- number of charging channels: 4
- number of batteries charged: 2, 4, 6 or 8
- charging current for AA: 250 mA
- charging current for AAA: 250 mA
- charging time AA 2 700 mAh: 10:00
- charging time AAA 1 000 mAh: 5:00
- packaging: 1 pc, small paper box



**B50829** 1/-/-/12  
16 04 882 110 E821

## EMOS Battery chargers

- for carefree charging of consumer NiMH batteries
- automatic start and end of charging
- capable of charging any number and size of batteries at the same time
- smart diagnostics and management of the charging process
- high final level of charge of the batteries
- other eco-friendly and safety features
- colour LEDs indicate the state of charge

- type of charger: intelligent
- charger design: USB
- power source: USB 5 V/2 A
- size of the charged cells: 10440 – 26650, AAA, AA, C
- special features: capacity check
- number of charging channels: 2
- number of batteries charged: 1 or 2
- charging current for AA: 1 000 mA
- charging current for AAA: 1 000 mA
- charging current for C: 1 000 mA
- charging time AA 2 700 mAh: 3:00
- charging time AAA 1 000 mAh: 1:15
- packaging: 1 pc, small paper box



**N9221** 1/-/-/60  
16 03 026 000 BCL-20D

- type of charger: intelligent
- charger design: USB
- power source: USB 5 V/1 A
- size of the charged cells: AAA, AA
- number of charging channels: 4
- number of batteries charged: 1 to 4
- charging current for AA: 300 mA
- charging current for AAA: 300 mA
- charging time AA 2 700 mAh: 10:00
- charging time AAA 1 000 mAh: 4:00
- packaging: 1 pc, small paper box



**N9321** 1/-/-/60  
16 03 027 000 BCN-40

- type of charger: intelligent
- charger design: USB
- power source: USB 5 V/1 A
- size of the charged cells: AAA, AA
- number of cells inside the package: 4
- type of cells inside the package: AA NiMH 2 700
- charging time of the enclosed cells: 4:00
- number of charging channels: 4
- number of batteries charged: 1 to 4
- charging current for AA: 1 000/500 mA
- charging current for AAA: 1 000/500 mA
- charging time AA 2 700 mAh: 3:00 - 4:00
- charging time AAA 1 000 mAh: 1:15 - 2:00
- packaging: 1 pc, small paper box



**N9331** 1/-/-/60  
16 03 028 000 BCN-41D



www.emos.eu

Order Code  
Item Number

Packaging  
Type

- type of charger: intelligent
- charger design: USB
- power source: USB 5 V/1 A
- size of the charged cells: AAA, AA
- special features: capacity check
- number of cells inside the package: 4
- type of cells inside the package: AA NiMH 2 700
- charging time of the enclosed cells: 3:00
- number of charging channels: 4
- number of batteries charged: 1 to 4
- charging current for AA: 1 000–250 mA
- charging current for AAA: 1 000–250 mA
- charging time AA 2 700 mAh: 3:00 - 12:00
- charging time AAA 1 000 mAh: 1:15 - 5:00
- packaging: 1 pc, small paper box



**N9341**

1/-/-/40

16 03 029 000

BCN-42D



- type of charger: intelligent
- charger design: USB
- power source: USB 5 V/2 A
- size of the charged cells: AAA, AA, C, D, 9 V
- number of charging channels: 7
- number of batteries charged: 1 to 6
- charging current for AA: 500 mA
- charging current for AAA: 500 mA
- charging current for C: 500 mA
- charging current for D: 500 mA
- charging current for 9 V: 30 mA
- charging time AA 2 700 mAh: 6:30
- charging time AAA 1 000 mAh: 2:30
- packaging: 1 pc, small paper box



**N9361**

1/-/-/30

16 03 030 000

BCN-60U



## Powerbanks

### GP Powerbanks



- 7 electronic safety protection features
- Specific models have wireless charging possibility
- All models are able to charge more devices simultaneously
- All models are capable of Light Load charging (for smart-watches, headphones)
- All models are equipped with LED Display or LED indication (MagSafe Wireless model)
- Passthrough function, auto On/Off

- battery capacity: 5 000 mAh/18.5 Wh
- battery type: Li-Po 3.7 V
- fast charging: PD 20 W
- max.input power: 18 W
- type of input interface: 1× USB-C
- charging time: 2 hours
- max.output power: 20 W
- type of output interface: 1× USB-C
- cable included: USB-C/USB-C
- LED charging indicator
- LED battery status indicator
- auto ON/OFF
- passthrough
- material: ABS plastic
- colour: black
- weight: 150 g
- dimensions: 111 × 63 × 18,5 mm



**B6305B**

1/-/2/20

16 11 630 500

Q05B





www.emos.eu

Order Code  
Item Number

Packaging  
Type

- battery capacity: 10 000 mAh/37 Wh
- battery type: Li-Po 3.7 V
- fast charging: PD 3.0, QC 3.0, PPS, SCP, FCP, AFC
- max.input power: 18 W
- type of input interface: 1× USB-C
- charging time: 2.5 hours
- max.output power: 22.5 W
- type of output interface: 2× USB-C, 1× USB-A
- cable included: USB-A/USB-C

- LED charging indicator
- LED battery status indicator
- passthrough
- material: ABS plastic
- colour: green
- weight: 240 g
- dimensions: 142 × 67 × 16 mm



**B6310G** 1/-/2/20  
16 11 631 000 GPM10CGR

- battery capacity: 10 000 mAh/37 Wh
- battery type: Li-Po 3.7 V
- fast charging: PD 3.0, QC 3.0, PPS, SCP, FCP, AFC
- max.input power: 18 W
- type of input interface: 1× USB-C
- charging time: 2.5 hours
- max.output power: 22.5 W
- type of output interface: 2× USB-C, 1× USB-A
- cable included: USB-A/USB-C

- LED charging indicator
- LED battery status indicator
- passthrough
- material: ABS plastic
- colour: blue
- weight: 240 g
- dimensions: 142 × 67 × 16 mm



**B6310BL** 1/-/2/20  
16 11 631 001 GPM10CBL

- battery capacity: 10 000 mAh/37 Wh
- battery type: Li-Po 3.7 V
- fast charging: PD 20 W + SCP 22.5 W + Dash + War
- max.input power: 18 W
- type of input interface: 1× USB-C
- charging time: 2.5 hours
- max.output power: 22.5 W
- type of output interface: 2× USB-C, 1× USB-A
- cable included: USB-A/USB-C

- LED charging indicator
- LED battery status indicator
- passthrough
- material: ABS plastic
- colour: beige
- weight: 240 g
- dimensions: 142 × 67 × 16 mm



**B6310BE** 1/-/2/20  
16 11 631 002 GPM10CBE

- battery capacity: 20 000 mAh/74 Wh
- battery type: Li-Po 3.7 V
- fast charging: PD 3.0, QC 3.0, PPS, SCP, FCP, AFC
- max.input power: 18 W
- type of input interface: 1× USB-C
- charging time: 5 hours
- max.output power: 22.5 W
- type of output interface: 2× USB-C, 1× USB-A
- cable included: USB-A/USB-C

- LED charging indicator
- LED battery status indicator
- passthrough
- material: ABS plastic
- colour: grey
- weight: 390 g
- dimensions: 146 × 68 × 29 mm



**B6320GY** 1/-/2/20  
16 11 632 000 GPM20CGY



# EMOS Powerbanks

- all models are compatible with USB-C or micro USB devices
- 6 electronic safety protection features
- cables with data transfer function are included
- certain models are featured with quick charge QC3.0 and PD18W
- excellent performance thanks to used high-quality battery and el.
- passthrough function, auto ON/OFF



- battery capacity: 5 000 mAh/18.5 Wh
- battery type: Li-Po 3.85 V
- fast charging: PD 20 W
- max.input power: 18 W
- type of input interface: 1× USB-C
- charging time: 2 hours
- max.output power: 20 W
- type of output interface: 1× USB-C
- cable included: USB-C/USB-C
- LED charging indicator
- LED battery status indicator
- auto ON/OFF
- passthrough
- material: ABS plastic
- colour: black
- weight: 118 g
- dimensions: 103 × 68 × 13 mm



8 592920 131695  
**B0545B** 1/-/-/28  
16 13 054 500 WI 521

- battery capacity: 10 000 mAh/38.5 Wh
- battery type: Li-Po 3.85 V
- fast charging: PD 20 W + SCP 22.5 W + Dash + War
- max.input power: 18 W
- type of input interface: 1× USB-C
- charging time: 4 hours (with QC)
- max.output power: 22.5 W
- type of output interface: 1× USB-A, 1× USB-C
- cable included: USB-A/USB-C, data
- LED charging indicator
- LED battery status indicator
- auto ON/OFF
- passthrough
- material: ABS plastic
- colour: black
- weight: 186 g
- dimensions: 109 × 68 × 20 mm



8 592920 119853  
**B0543B** 1/-/-/28  
16 13 054 300 WI 1023D

- battery capacity: 10 000 mAh/37 Wh
- battery type: Li-Po 3.7 V
- fast charging: PD 20 W + SCP 22.5 W + Dash + War
- max.input power: 18 W
- type of input interface: 1× micro USB, 1× USB-C
- charging time: 4 hours
- max.output power: 22.5 W
- type of output interface: 2× USB-A, 1× USB-C
- cable included: USB-A/USB-C, data
- LED charging indicator
- LED battery status indicator
- auto ON/OFF
- passthrough
- material: ABS plastic
- colour: black
- weight: 233 g
- dimensions: 143 × 68 × 16 mm



8 592920 124772  
**B0531B** 1/-/-/20  
16 13 053 100 BETAQ 10

- battery capacity: 20 000 mAh/74 Wh
- battery type: Li-Po 3.7 V
- fast charging: PD 20 W + SCP 22.5 W + Dash + War
- max.input power: 18 W
- type of input interface: 1× micro USB, 1× USB-C
- charging time: 7 hours (with QC)
- max.output power: 22.5 W
- type of output interface: 2× USB-A, 1× USB-C
- cable included: USB-A/USB-C, data
- LED charging indicator
- LED battery status indicator
- auto ON/OFF
- passthrough
- material: ABS plastic
- colour: black
- weight: 409 g
- dimensions: 143 × 68 × 28 mm



8 592920 124796  
**B0532B** 1/-/-/12  
16 13 053 200 BETAQ 20



- battery capacity: 10 000 mAh/37 Wh
- battery type: Li-Po 3.7 V
- fast charging: no
- max.input power: 10 W
- type of input interface: micro USB
- charging time: 6 hours
- max.output power: 10,5 W
- type of output interface: 2× USB-A
- cable included: micro USB, USB-C, data
- LED charging indicator
- LED battery status indicator
- auto ON/OFF
- passthrough
- material: ABS plastic
- colour: black
- weight: 220 g
- dimensions: 138 × 68 × 16 mm



**B0526B** 1/-/-/28  
16 13 052 600 ALPHA 10S

- battery capacity: 20 000 mAh/74 Wh
- battery type: Li-Po 3.7 V
- fast charging: no
- max.input power: 10 W
- type of input interface: 1× micro USB, 1× USB-C
- charging time: 12 hours
- max.output power: 10 W
- type of output interface: 2× USB-A, 1× USB-C
- cable included: USB-A/USB-C, data
- LED charging indicator
- LED battery status indicator
- auto ON/OFF
- passthrough
- material: ABS plastic
- colour: black
- weight: 412 g
- dimensions: 142 × 67 × 27 mm



**B0527B** 1/-/-/24  
16 13 052 700 ALPHA2 20

## USB chargers

- faster charging than via USB port on laptop
- USB adapters for standard socket or car with 1–4 USB ports
- smart functions for fast charging and device protection
- minimum energy losses during transfer
- BASIC–Economy line of high-quality chargers
- SMART–Higher current allows charging multiple devices at once
- QUICK–Quick charging for devices with Qualcomm processors

max. output 1× USB: 5 V/2.1 A/10.5 W = max. output total: 5 V/3.1 A/15.5 W = input voltage: 100–240 V~ 50/60 Hz = charging: smart = number of USB outputs: 2 = protection against overload, overvoltage and short circuit = designed for: smartphone, tablet = dimensions: 80 × 39 × 27 mm = packaging: 1 pc, blister



**V0125** 1/-/4/36  
17 04 012 500 V0125

max. output 1× USB: QC 3.0-2.0 (5–12 V/1.5–3.0 A/18 W) = max. output total: QC 3.0-2.0 (5–12 V/1.5–3.0 A/18 W) = input voltage: 100–240 V~ 50/60 Hz = charging: quick = number of USB outputs: 1 = protection against overload, overvoltage and short circuit = designed for: smartphone, tablet = dimensions: 87 × 44 × 25 mm = packaging: 1 pc, blister



**V0123** 1/-/-/50  
17 04 012 300 V0123

max. output 1× USB: 5 V/1 A/5 W = max. output total: 5 V/1 A/5 W = input voltage: 100–240 V~ 50/60 Hz = charging: basic = number of USB outputs: 1 = protection against overload, overvoltage and short circuit = designed for: smartphone = dimensions: 78 × 34 × 21 mm = packaging: 1 pc, blister



**V0122** 1/-/25/50  
17 04 012 200 V0122

max. output 1× USB: QC 3.0–2.0, PD (5–12 V/1.5–3.0 A/18 W) = max. output total: QC 3.0–2.0, PD (5–12 V/1.5–3.0 A/30 W) = input voltage: 100–240 V~ 50/60 Hz = charging: quick = number of USB outputs: 2 = protection against overload, overvoltage and short circuit = designed for: smartphone, tablet = dimensions: 91 × 54 × 27 mm = packaging: 1 pc, blister



**V0120** 1/-/-/56  
17 04 012 000 V0120

max. output 1× USB: 5 V/2.1 A/10.5 W = max. output total: 5 V/2.1 A/10.5 W = input voltage: 12–24 V DC = charging: basic = number of USB outputs: 1 = protection against overload, overvoltage and short circuit = designed for: smartphone, tablet = LED indicators = power supply type: micro USB cable 1 m, USB-C reduction in packaging = dimensions: 65 × 28 × 28 mm = packaging: 1 pc, blister



**V0219** 1/-/-/25  
17 04 021 900 V0219

## Universal adaptors

- EMOS adapters come with a set of replaceable connectors
- SMPS suitable for light-current devices (torches, antennas)

max. output 1× USB: 5 V/2.0 A/10 W = max. output total: 5 V/2.0 A/10 W = input voltage: 100–240 V~ 50/60 Hz = number of USB outputs: 1 = protection against overload, overvoltage and short circuit = designed for: universal = LED indicators = output voltage: 3 V, 4.5 V, 5 V, 6 V, 7.5 V, 9 V, 12 V = output current: max. 2 250 mA = size of the connector: B 3.5/15; C 3.0×1.0/10; D 5.0×2.1/12; G 5.5×2.5/10; H 3.5×1.35/10; I 4×1.7/10; S 2.35×0.75/8.7 = power supply type: cable + set of DC connectors + USB out = dimensions: 50 × 80 × 32 mm = packaging: 1 pc, blister



**N3113** 1/-/-/24  
17 03 225 021 N3113



www.emos.eu

Order Code  
Item Number

Packaging  
Type

max. output 1× USB: 5 V/2.0 A/10 W = max. output total: 5 V/2.0 A/10 W = input voltage: 100–240 V~ 50/60 Hz = number of USB outputs: 1 = protection against overload, overvoltage and short circuit = designed for: universal = LED indicators = output voltage: 3 V, 4.5 V, 5 V, 6 V, 7.5 V, 9 V, 12 V = output current: max. 1 500 mA = size of the connector: B 3.5/15; C 3.0×1.0/10; D 5.0×2.1/12; G 5.5×2.5/10; H 3.5×1.35/10; I 4×1.7/10; S 2.35×0.75/8.7 = power supply type: cable + set of DC connectors + USB out = dimensions: 50 × 80 × 32 mm = packaging: 1 pc, blister



**N3112** 1/-/-/24  
17 03 150 021 N3112

max. output 1× USB: 5 V/2.0 A/10 W = max. output total: 5 V/2.0 A/10 W = input voltage: 100–240 V~ 50/60 Hz = number of USB outputs: 1 = protection against overload, overvoltage and short circuit = designed for: universal = LED indicators = output voltage: 3 V, 4.5 V, 5 V, 6 V, 7.5 V, 9 V, 12 V = output current: max. 1 000 mA = size of the connector: B 3.5/15; C 3.0×1.0/10; D 5.0×2.1/12; G 5.5×2.5/10; H 3.5×1.35/10; I 4×1.7/10; S 2.35×0.75/8.7 = power supply type: cable + set of DC connectors + USB out = dimensions: 50 × 80 × 32 mm = packaging: 1 pc, blister



**N3111** 1/-/-/24  
17 03 100 021 N3111

input voltage: 100–240 V~ 50/60 Hz = protection against overload, overvoltage and short circuit = designed for: universal = LED indicators = output voltage: 3 V, 4.5 V, 5 V, 6 V, 7.5 V, 9 V, 12 V = output current: max. 600 mA = size of the connector: B 3.5/15; C 3.0×1.0/10; D 5.0×2.1/12; G 5.5×2.5/10; H 3.5×1.35/10; I 4×1.7/10; S 2.35×0.75/8.7 = power supply type: cable + set of DC connectors = dimensions: 36 × 66 × 30 mm = packaging: 1 pc, blister



**N3110** 1/-/-/20  
17 03 060 021 N3110

## Car battery chargers, testers

- for charging car batteries and other accumulators
- with voltage of 6 or 12 V and capacity of 1.2–120 Ah
- diagnoses type of connected battery, auto-selects programme
- adapts charging speed and intensity to ambient temperature
- non-stop connection extends battery life in rarely-used cars
- restores slightly damaged accumulators to original condition
- with short-circuit and reversed polarity protection

designed for: cars, motorcycles, backup batteries, lead acid battery WET (acid), MF (Maintenance Free), VRLA, AGM and GEL = charging: 6 V (1.2 Ah–14 Ah), 12 V (1.2 Ah–120 Ah) = charging cable: 1.8 m is terminated by clips = desulfation mode = sustaining mode = cold weather program = protection against short circuit and reverse polarity = entrance: 220–240 V AC/50 Hz/600 mA = IP rating: IP65 = packaging: 1 pc, box



**N1014** 1/-/-/12  
16 06 025 000 EE04A





www.emos.eu

Order Code  
Item Number

Packaging  
Type

designed for: cars, motorbikes, backup accumulator, SLA battery WET (acid), MF (maintenance-free), VRLA, AGM + GEL and 12.8 V LiFePO4 = charging: 6 V (1.2 Ah-30 Ah), 12 V (1.2 Ah-30 Ah); 12.8 V LiFePO4 (2 Ah-15 Ah) = charging cable: 1.8 m is terminated by clips = disulfation mode = sustaining mode = protection against short circuit and reverse polarity = entrance: 220-240 V AC/50 Hz/300 mA = IP rating: IP65 (charger cover) = packaging: 1 pc, box



--	--	--	--	--	--

--	--	--



<b>N1015</b>	1/-/-/20
16 08 000 001	E-CC008A

# Portable Lighting



## GP

## Flashlights

### GP Discovery



- quality all-metal GP torches for daily use
- powerful yet efficient LED chips (CREE LED in some models)
- compatible with alkaline and rechargeable batteries
- anti-scratch surface finish
- water-resistance up to IPX7 (CR41 usable briefly underwater)

- source of light: CREE SMD LED
- maximal light output: 650 lm
- maximal beam distance: 135 m
- number of lighting modes: 4
- runtime: 5.5-40 hrs
- focus
- impact resistance: 1 m
- waterproof: IPX7
- rechargeable

- battery: Li-Ion
- battery type: 18650/3,7 V/2 550 mAh
- batteries included
- recharge time: 3 hrs
- power connector type: micro USB
- features: textile loop
- dimensions: 33 × 136 mm
- weight: 179 g
- packaging: 1 pc, small paper box



**P8511** 1/-/-12  
14 51 704 100 CR41

- source of light: CREE SMD LED
- maximal light output: 300 lm
- maximal beam distance: 100 m
- number of lighting modes: 3
- runtime: 4.5-15 hrs
- focus
- impact resistance: 1 m
- waterproof: IPX4
- rechargeable: no

- battery: 3× AAA
- battery type: LR03 (1.5 V)
- batteries included
- features: textile loop
- dimensions: 32 × 108 mm
- weight: 120 g
- packaging: 1 pc, small paper box



**P8506** 1/-/-12  
14 51 703 200 C32



www.emos.eu

Order Code  
Item Number

Packaging  
Type

- source of light: COB LED + CREE SMD LED
- maximal light output: 180 lm
- maximal beam distance: 100 m
- number of lighting modes: 3
- runtime: 2-20 hrs
- focus
- impact resistance: 1 m
- waterproof: IPX4
- rechargeable: no
- battery: 2× AA
- battery type: LR6 (1,5 V)
- batteries included
- features: magnet, metal clip
- dimensions: 26 × 165 mm
- weight: 128 g
- packaging: 1 pc, small paper box



**P8504** 1/-/-/12  
14 51 703 300 C33

- source of light: 1× LED
- maximal light output: 20 lm
- maximal beam distance: 25 m
- number of lighting modes: 1
- runtime: 3 hrs
- impact resistance: 1 m
- waterproof: IPX4
- rechargeable: no
- battery: 1× AAA
- battery type: LR03 (1.5 V)
- batteries included
- features: metal snap-hook
- dimensions: 18 × 89 mm
- weight: 37 g
- packaging: 1 pc, small paper box



**P8502** 1/-/12/72  
14 51 701 200 CK12

- source of light: CREE SMD LED
- maximal light output: 100 lm
- maximal beam distance: 75 m
- number of lighting modes: 2
- runtime: 2-7 hours
- impact resistance: 1 m
- waterproof: IPX4
- rechargeable: no
- battery: 1× AA
- battery type: LR6 (1,5 V)
- batteries included
- features: textile loop
- dimensions: 22.5 × 95 mm
- weight: 64 g
- packaging: 1 pc, small paper box



**P8507** 1/-/-/12  
14 51 703 110 C31X

- source of light: COB LED + CREE LED
- maximal light output: 550 lm
- maximal beam distance: 110 m
- number of lighting modes: 4
- runtime: 20 hrs
- impact resistance: 1 m
- waterproof: IPX4
- rechargeable: no
- battery: 3× AA
- battery type: LR6 (1,5 V)
- batteries included
- features: magnet, metal clip
- dimensions: 27.5 × 193 mm
- weight: 217 g
- packaging: 1 pc, small paper box



**P8508** 1/-/-/12  
14 51 703 402 C34

# GP Everyday



- lightweight and compact flashlights for everyday use
- ready-made fixing for any wrist strap
- focus on the head of the flashlight for precise light focusing
- made of durable plastic

- source of light: LED
- maximal light output: 50 lm
- maximal beam distance: 30 m
- number of lighting modes: 1
- runtime: 24 hours
- focus: yes (screwable)
- impact resistance: 1 m
- waterproof: IPX4
- rechargeable: no
- battery: 1× AA 1.5 V
- battery type: LR6 (1,5 V)
- batteries included
- features: hole for strap
- dimensions: 36 × 126 mm
- weight: 62 g
- packaging: 1 pc, blister



**P8105** 1/-/-12  
14 51 710 500 C105

- source of light: LED
- maximal light output: 70 lm
- maximal beam distance: 45 m
- number of lighting modes: 1
- runtime: 24 hours
- focus: yes (screwable)
- impact resistance: 1 m
- waterproof: IPX4
- rechargeable: no
- battery: 2× AA
- battery type: LR6 (1,5 V)
- batteries included
- features: hole for strap
- dimensions: 42 × 166 mm
- weight: 106 g
- packaging: 1 pc, blister



**P8107** 1/-/-12  
14 51 710 700 C107



# GP

## Headlights

### GP Xplor



- ultra-light trail running headlamps
- natural part of sports and professional equipment
- quality CREE LED chips for high luminous flux: 300–500 lm
- water-resistant (IPX6) and impact-resistant (from up to 1 m)
- AAA powered or as a rechargeable version
- compatible with single-use and rechargeable batteries
- Button Lock – protects against switching on accidentally

- source of light: 3× CREE SMD LED
- maximal light output: 500 lm
- maximal beam distance: 85 m
- number of lighting modes: 10
- runtime: 60 s – 100 hrs
- focus: no
- reflective head strap
- impact resistance: 1 m
- waterproof: IPX6

- charging
- power supply: Li-Po
- battery type: Li-Po 1 600 mAh
- batteries included
- special function: button lock mode
- accessories: USB-C cable
- dimensions: 56 × 38 × 39 mm
- weight: 59.5 g
- packaging: 1 pc, small paper box



**P8567** 1/-/-/10  
14 51 085 670 PHR17

- source of light: 2× CREE SMD LED
- maximal light output: 300 lm
- maximal beam distance: 50 m
- number of lighting modes: 9
- runtime: 60 s – 45 hrs
- focus: no
- reflective head strap
- impact resistance: 1 m
- waterproof: IPX6

- charging
- power supply: Li-Po
- battery type: Li-Po 800 mAh
- batteries included
- special function: button lock mode
- accessories: USB-C cable
- dimensions: 56 × 38 × 34 mm
- weight: 44 g
- packaging: 1 pc, small paper box



**P8566** 1/-/-/10  
14 51 085 660 PHR16

- source of light: 2× Osram SMD LED
- maximal light output: 1 200 lm
- maximal beam distance: 110 m
- number of lighting modes: 11
- runtime: 2–100 hrs
- focus: no
- reflective head strap
- impact resistance: 1.5 m
- waterproof: IPX8

- charging
- power supply: Li-ion/2× CR123A
- battery type: 18650/3,7 V/2 550 mAh
- batteries included
- special function: button lock mode
- accessories: USB-A=>USB-C cable 30 cm
- dimensions: 91.5 × 39 × 51 mm
- weight: 90 g/151 g
- packaging: 1 pc, small paper box



**P8569** 1/-/-/10  
14 51 701 900 PHR19

# GP Discovery



- quality all-metal GP headlamps for daily use
- powerful yet efficient LED chips (CREE LED in some models)
- compatible with alkaline and rechargeable batteries
- anti-scratch surface finish
- water-resistance up to IPX7 (CR41 usable briefly underwater)

- source of light: CREE SMD LED
- maximal light output: 600 lm
- maximal beam distance: 130 m
- number of lighting modes: 5
- runtime: 40 s – 60 hrs
- focus: no
- reflective head strap: no
- impact resistance: 1 m
- waterproof: IPX4

- charging
- power supply: Li-Ion
- battery type: 18650/3,7 V/2 550 mAh
- batteries included
- special function: button lock mode
- accessories: micro USB cable
- dimensions: 106 × 27 × 27 mm
- weight: 153 g
- packaging: 1 pc, small paper box



**P8555** 1/-/-/10  
14 51 703 500 CHR35

- source of light: CREE SMD LED
- maximal light output: 300 lm
- maximal beam distance: 157 m
- number of lighting modes: 4
- runtime: 5–69 hrs
- focus: no
- reflective head strap: no
- impact resistance: 1 m
- waterproof: IPX6

- charging
- power supply: 3× AAA
- battery type: HR03 (1.5 V)
- batteries included
- special function: auto-dimming mode, button lock mode
- accessories: micro USB cable
- dimensions: 34 × 46 × 56 mm
- weight: 110 g
- packaging: 1 pc, small paper box



**P8572** 1/-/6/24  
14 51 704 101 CHR41

- source of light: CREE SMD LED
- maximal light output: 300 lm
- maximal beam distance: 157 m
- number of lighting modes: 4
- runtime: 5–69 hrs
- focus: no
- reflective head strap: no
- impact resistance: 1 m
- waterproof: IPX6

- charging: no
- power supply: 3× AAA
- battery type: LR03 (1.5 V)
- batteries included
- special function: touchless dimming
- dimensions: 34 × 46 × 56 mm
- weight: 110 g
- packaging: 1 pc, small paper box



**P8571** 1/-/6/24  
14 51 704 600 CH46

- source of light: 4× LED
- maximal light output: 40 lm
- maximal beam distance: 8 m
- number of lighting modes: 3
- runtime: 2–6 hrs
- focus: no
- reflective head strap: no
- impact resistance: 1 m
- waterproof: no

- charging: no
- power supply: 2× CR2025
- batteries included
- dimensions: 37 × 36 × 20 mm
- weight: 31 g
- packaging: 1 pc, blister



**P8551P** 1/-/-/12  
14 51 703 102 CH31



www.emos.eu

Order Code  
Item Number

Packaging  
Type

- source of light: 2× SMD LED
- maximal light output: 110 lm
- maximal beam distance: 40 m
- number of lighting modes: 4
- runtime: 15 hours
- focus: no
- reflective head strap: no
- impact resistance: 1 m
- waterproof: IP43

- charging: no
- power supply: 3× AAA
- battery type: LR03 (1.5 V)
- batteries included
- dimensions: 59 × 46 × 34 mm
- weight: 29 g/65 g
- packaging: 1 pc, small paper box



**P8582** 1/-/-/10  
14 51 704 200 CH42

- source of light: 2× SMD LED + LED
- maximal light output: 150 lm
- maximal beam distance: 45 m
- number of lighting modes: 5
- runtime: 36 hours
- focus: no
- reflective head strap: no
- impact resistance: 1 m
- waterproof: IPX4

- charging: no
- power supply: 3× AAA
- battery type: LR03 (1.5 V)
- batteries included
- dimensions: 61 × 47 × 37 mm
- weight: 42 g/78 g
- packaging: 1 pc, small paper box



**P8583** 1/-/-/10  
14 51 704 300 CH43

- source of light: 2× SMD LED
- maximal light output: 300 lm
- maximal beam distance: 60 m
- number of lighting modes: 6
- runtime: 36 hours
- focus: no
- reflective head strap: no
- impact resistance: 1 m
- waterproof: IPX4

- charging: no
- power supply: 3× AAA
- battery type: LR03 (1.5 V)
- batteries included
- special function: touchless control
- dimensions: 61 × 47 × 37 mm
- weight: 42 g/78 g
- packaging: 1 pc, small paper box



**P8584** 1/-/-/10  
14 51 704 400 CH44

- source of light: 2× CREE SMD LED
- maximal light output: 280 lm
- maximal beam distance: 90 m
- number of lighting modes: 6
- runtime: 25 hours
- focus: no
- reflective head strap: no
- impact resistance: 5 m
- waterproof: IPX5

- charging: no
- power supply: 3× AAA
- battery type: LR03 (1.5 V)
- batteries included
- dimensions: 66 × 49 × 37 mm
- weight: 95 g
- packaging: 1 pc, small paper box



**P8573** 1/-/-/10  
14 51 705 300 CHW53

- source of light: 2× CREE SMD LED
- maximal light output: 375 lm
- maximal beam distance: 110 m
- number of lighting modes: 4
- runtime: 26 hours
- focus: no
- reflective head strap: no
- impact resistance: 5 m
- waterproof: IPX5

- charging: no
- power supply: 3× AAA
- battery type: LR03 (1.5 V)
- batteries included
- special function: touchless dimming
- dimensions: 66 × 49 × 37 mm
- weight: 62 g/98 g
- packaging: 1 pc, small paper box



**P8574** 1/-/-/10  
14 51 705 400 CHW54



# EMOS

## LED Metal Flashlights

### ULTIBRIGHT Flashlights

### ULTIBRIGHT

- ULTIBRIGHT premium flashlights – compact, durable and reliable
- distinguished by an elegant red ring
- designer flashlights made of durable metal
- reliably withstand impact from falling onto a hard surface
- extraordinary luminous flux and beam distance thanks to a brand-name CREE LED chip
- easy to keep on hand thanks to their compact size practical clip and reliable strap

- source of light: CREE LED
- maximal light output: 1 200 lm
- maximal beam distance: 280 m
- number of lighting modes: 3
- runtime: 3–11 hrs
- focus: yes (screwable)
- impact resistance
- waterproof: yes (IP65)
- rechargeable

- battery: Li-Ion 26650
- battery type: 5 000 mAh/3.7 V
- batteries included
- recharge time: 11.5 hrs
- power connector type: USB C
- features: hand strap
- dimensions: 157 × 40 × 40 mm
- weight: 198 g (without battery)
- packaging: 1 pc, box



**P3190** 1/-/4/16  
14 50 000 340 P3190

- source of light: CREE LED
- maximal light output: 600 lm
- maximal beam distance: 230 m
- number of lighting modes: 3
- runtime: 3.5–12 hrs
- focus: yes (screwable)
- impact resistance
- waterproof: yes (IP65)
- rechargeable

- battery: Li-Ion 18650
- battery type: 2 600 mAh/3.7 V
- batteries included
- recharge time: 4.5 hrs
- power connector type: USB C
- features: hand strap
- dimensions: 151 × 34 × 34 mm
- weight: 189 g
- packaging: 1 pc, box



**P3180** 1/-/4/16  
14 50 000 330 P3180

- source of light: CREE LED
- maximal light output: 340 lm
- maximal beam distance: 200 m
- number of lighting modes: 2
- runtime: 3–5.5 hrs
- focus: yes (screwable)
- impact resistance
- waterproof: yes (IP65)
- rechargeable: no

- battery: 3× AAA
- battery type: LR03 (1.5 V)
- batteries included: no
- features: clip, loop
- dimensions: 124 × 34 × 34 mm
- weight: 112 g
- packaging: 1 pc, box



**P3170** 1/-/4/16  
14 40 013 123 P3170





www.emos.eu

Order Code  
Item Number

Packaging  
Type

- source of light: CREE LED
- maximal light output: 170 lm
- maximal beam distance: 100 m
- number of lighting modes: 1
- runtime: 2.5 hrs
- impact resistance
- waterproof: yes (IP65)
- rechargeable: no
- battery: 1× AA

- battery type: LR6 (1,5 V)
- batteries included: no
- features: clip, loop
- dimensions: 101 × 22 × 22 mm
- weight: 47 g
- packaging: 1 pc, box



**P3160** 1/-/8/32  
14 40 011 203 P3160

- source of light: CREE LED
- maximal light output: 100 lm
- maximal beam distance: 65 m
- number of lighting modes: 1
- runtime: 3 hrs
- impact resistance
- waterproof: yes (IP65)
- rechargeable: no
- battery: 1× AAA

- battery type: LR03 (1.5 V)
- batteries included: no
- features: clip, loop
- dimensions: 98 × 16 × 16 mm
- weight: 32 g
- packaging: 1 pc, box



**P3150** 1/-/8/32  
14 40 011 100 P3150

## EMOS Flashlights

- quality aluminium casing ensures lightness and durability
- battery-powered and rechargeable
- run time up to 35 hours
- maximal beam distance up to 230 m

- source of light: LED
- maximal light output: 600 lm
- maximal beam distance: 230 m
- number of lighting modes: 3
- runtime: 4–8 hrs
- focus
- impact resistance
- waterproof: yes (IP44)
- rechargeable

- battery: Li-Ion 18650 or 3× AAA
- battery type: 2 000 mAh/3.7 V or LR03 (1.5 V)
- batteries included
- recharge time: 4 hrs
- power connector type: USB C
- features: hand strap
- dimensions: 183 × 41 × 41 mm
- weight: 230 g
- packaging: 1 pc, box

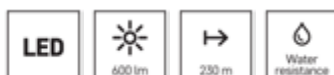

**P3116** 1/-/10/20  
14 40 011 500 P3116

- source of light: LED
- maximal light output: 500 lm
- maximal beam distance: 160 m
- number of lighting modes: 3
- runtime: 5.5–22 hrs
- focus
- impact resistance
- waterproof: yes (IP44)
- rechargeable: no

- battery: 4× AAA
- battery type: LR03 (1.5 V)
- batteries included: no
- features: hand strap
- dimensions: 128 × 37 × 37 mm
- weight: 129 g
- packaging: 1 pc, paper blister



**P3115** 1/-/6/24  
14 40 014 100 P3115



- source of light: LED
- maximal light output: 330 lm
- maximal beam distance: 120 m
- number of lighting modes: 3
- runtime: 10-27 hrs
- focus
- impact resistance
- waterproof: yes (IP44)
- rechargeable: no

- battery: 3× AAA
- battery type: LR03 (1.5 V)
- batteries included: no
- features: hand strap
- dimensions: 128 × 37 × 37 mm
- weight: 121 g
- packaging: 1 pc, paper blister



**P3114** 1/-/6/24  
14 40 013 125 P3114

- source of light: LED
- maximal light output: 120 lm
- maximal beam distance: 90 m
- number of lighting modes: 1
- runtime: 7 hrs
- focus
- impact resistance
- waterproof: yes (IP44)
- rechargeable: no

- battery: 2× AAA
- battery type: LR03 (1.5 V)
- batteries included: no
- features: hand strap
- dimensions: 131 × 21 × 21 mm
- weight: 48 g
- packaging: 1 pc, paper blister



**P3113** 1/-/6/30  
14 40 012 111 P3113

- source of light: COB LED + LED
- maximal light output: 270 lm
- maximal beam distance: 145 m
- number of lighting modes: 5
- runtime: 4-15 hrs
- impact resistance
- waterproof: yes (IP44)
- rechargeable: no
- battery: 2× AA

- battery type: LR6 (1.5 V)
- batteries included: no
- features: clip, 1× magnet
- dimensions: 171 × 30 × 30 mm
- weight: 108 g
- packaging: 1 pc, paper blister



**P3112** 1/-/6/24  
14 40 022 200 P3112

- source of light: LED + COB LED
- maximal light output: 230 lm
- maximal beam distance: 210 m
- number of lighting modes: 3
- runtime: 1.5-6 hrs
- focus
- impact resistance: no
- waterproof: no
- rechargeable: no

- battery: 3× AAA
- battery type: LR03 (1.5 V)
- batteries included: no
- features: loop, 1× magnet
- dimensions: 150 × 37 × 37 mm
- weight: 158 g
- packaging: 1 pc, blister



**P3111** 1/-/6/18  
14 40 813 170 E-1631-1

- source of light: COB LED
- maximal light output: 120 lm
- maximal beam distance: 20 m
- number of lighting modes: 1
- runtime: 60 hrs
- impact resistance
- waterproof: yes (IP43)
- rechargeable: no
- battery: 3× AAA

- battery type: LR03 (1.5 V)
- batteries included: no
- features: hand strap
- dimensions: 102 × 28 × 28 mm
- packaging: 1 pc, blister



**P4704** 1/-/12/60  
14 40 813 150 E-2217



- source of light: COB LED
- maximal light output: 100 lm
- maximal beam distance: 15 m
- number of lighting modes: 1
- runtime: 35 hrs
- impact resistance
- waterproof: no
- rechargeable: no
- battery: 3× AAA

- battery type: LR03 (1.5 V)
- batteries included: no
- features: hand strap
- dimensions: 85 × 25 × 25 mm
- weight: 34 g
- packaging: 1 pc, blister



**P3894**  
14 40 813 110

1/-/12/60  
E3221

# EMOS

## LED Plastic Flashlights

- efficient, yet inexpensive light source
- compact and light
- for battery types: AA, AAA or D
- run time up to 140 hours
- maximal beam distance up to 305 m

- source of light: SMD LED + LED
- maximal light output: 215 lm
- maximal beam distance: 305 m
- number of lighting modes: 5
- runtime: 90 hrs
- impact resistance: no
- waterproof: no
- rechargeable: no
- battery: 3× AA

- battery type: LR6 (1,5 V)
- batteries included: no
- dimensions: 80 × 130 × 150 mm
- weight: 210 g
- packaging: 1 pc, box



**P4008**  
14 47 013 200

1/-/8/16  
P4008

- source of light: LED
- maximal light output: 75 lm
- maximal beam distance: 130 m
- number of lighting modes: 1
- runtime: 72 hrs
- focus
- impact resistance
- waterproof: yes (IP43)
- rechargeable: no

- battery: 3× AAA
- battery type: LR03 (1.5 V)
- batteries included: no
- features: hand strap
- dimensions: 120 × 35 × 35 mm
- weight: 83 g
- packaging: 1 pc, paper blister



**P4702**  
14 40 013 114

1/-/10/50  
E-1512

- source of light: LED
- maximal light output: 55 lm
- maximal beam distance: 125 m
- number of lighting modes: 1
- runtime: 16 hrs
- impact resistance
- waterproof: no
- rechargeable: no
- battery: 2× AA



- battery type: LR6 (1,5 V)
- batteries included: no
- features: hand strap
- dimensions: 155 × 45 × 45 mm
- weight: 73 g
- packaging: 1 pc, paper blister



**P3210**  
14 40 004 904

1/-/6/24  
E-5134

- source of light: LED
- maximal light output: 20 lm
- maximal beam distance: 35 m
- number of lighting modes: 1
- runtime: 30 hrs
- impact resistance
- waterproof: yes (IP43)
- rechargeable: no
- battery: 2× AA



- battery type: LR6 (1,5 V)
- batteries included: no
- features: hand strap
- dimensions: 162 × 43 × 43 mm
- weight: 85 g
- packaging: 1 pc, paper blister



**P3861**  
14 40 032 202

1/-/-/24  
HL-R0217-2AA

- source of light: LED
- maximal light output: 20 lm
- maximal beam distance: 75 m
- number of lighting modes: 1
- runtime: 140 hrs
- impact resistance: no
- waterproof: yes (IP43)
- rechargeable: no
- battery: 2× D



- battery type: LR20 (1.5 V)
- batteries included: no
- features: hand strap
- dimensions: 190 × 68 × 68 mm
- weight: 216 g
- packaging: 1 pc, paper blister



**P3862**  
14 40 032 400

1/-/-/10  
HL-R0217-2D

- source of light: COB LED
- maximal light output: 300 lm
- maximal beam distance: 15 m
- number of lighting modes: 1
- runtime: 5 hrs
- impact resistance
- rechargeable: no
- battery: 3× AA
- battery type: LR6 (1,5 V)



- batteries included: no
- features: 1× hook, 1× magnet
- dimensions: 85 × 130 × 85mm
- packaging: 1 pc, box



**P4006**  
14 47 003 100

1/-/-/16  
E-6020

- source of light: LED
- maximal light output: 10 lm
- maximal beam distance: 7 m
- number of lighting modes: 2
- runtime: 25–35 hrs
- rechargeable: no
- battery: 1× AAA
- battery type: LR03 (1.5 V)
- batteries included: no



- features: clip
- dimensions: 259 × 20 × 25 mm
- weight: 30 g
- packaging: 1 pc, blister



**P3400**  
14 40 211 100

1/-/10/20  
P3400





www.emos.eu

Order Code  
Item Number

Packaging  
Type

- source of light: LED + COB LED
- maximal light output: 150 lm
- maximal beam distance: 150 m
- number of lighting modes: 4
- runtime: 2-4,5 h
- focus
- impact resistance
- waterproof: IP44
- rechargeable
- battery: Li-Ion 18650
- battery type: 1 200 mAh/3.7 V
- batteries included
- recharge time: 2 hrs
- power connector type: micro USB B
- dimensions: 130 × 35 × 35 mm
- weight: 80 g



**P3213** 1/-/6/24  
14 40 004 907 P3213

## LED Headlights

- indispensable part of outdoor gear
- selected models contains top quality CREE LED chips
- battery-powered and rechargeable models
- multiple light modes
- maximal beam distance up to 200 m
- run time up to 50 hours

- source of light: COB LED + LED
- maximal light output: 380 lm
- maximal beam distance: 30 m
- number of lighting modes: 4
- runtime: 3-12 hrs
- focus: no
- reflective head strap: no
- impact resistance
- waterproof: yes (IP43)
- charging
- power supply: Li-pol
- battery type: 1 200 mAh/3.7 V
- batteries included
- special function: hand-operated switching, quick swi
- accessories: USB-C cable
- dimensions: 300 × 3.2 × 20 mm
- weight: 73 g
- packaging: 1 pc, small paper box



**P3541** 1/-/6/24  
14 41 292 150 P3541

- source of light: CREE LED
- maximal light output: 230 lm
- maximal beam distance: 80 m
- number of lighting modes: 4
- runtime: 3-13 hrs
- focus: no
- reflective head strap
- impact resistance
- waterproof: no
- charging
- power supply: Li-pol
- battery type: 1 200 mAh (3.7 V)
- batteries included
- special function: hand-operated switching, quick swi
- accessories: power cable
- dimensions: 61 × 37 × 31 mm
- weight: 60 g
- packaging: 1 pc, paper blister



**P3534** 1/-/10/40  
14 41 250 920 E-943

- source of light: CREE LED + 4× SMD
- maximal light output: 110 lm
- maximal beam distance: 55 m
- number of lighting modes: 3
- runtime: 3-7 hrs
- focus: no
- reflective head strap
- impact resistance: no
- waterproof: no
- charging
- power supply: Li-pol
- battery type: 850 mAh (3.7 V)
- batteries included
- special function: quick switch ON/OFF, battery prote
- accessories: power cable
- dimensions: 47 × 31 × 54 mm
- weight: 64 g
- packaging: 1 pc, paper blister



**P3535** 1/-/6/36  
14 41 251 900 E-HL030



www.emos.eu

Order Code  
Item Number

Packaging  
Type

- source of light: CREE LED + COB LED (green, red) +
- maximal light output: 330 lm
- maximal beam distance: 65 m
- number of lighting modes: 7
- runtime: 18-72 hrs
- focus: no
- reflective head strap
- impact resistance
- waterproof: yes (IP44)

- charging: no
- power supply: 3× AAA + 1× CR2032
- battery type: LR03 (1.5 V) + CR2032 (3 V)
- batteries included: 1× CR2032
- special function: quick switch ON/OFF
- accessories: helmet hooks
- dimensions: 65 × 32 × 39 mm
- weight: 80 g/115 g
- packaging: 1 pc, paper blister



**P3531** 1/-/6/24  
14 41 233 110 E1801

- source of light: CREE LED + 2× red LED
- maximal light output: 330 lm
- maximal beam distance: 200 m
- number of lighting modes: 5
- runtime: 50-87 hrs
- focus
- reflective head strap: no
- impact resistance
- waterproof: yes (IP43)

- charging: no
- power supply: 3× AAA
- battery type: LR03 (1.5 V)
- batteries included: no
- special function: quick switch ON/OFF, focus
- dimensions: 60 × 48 × 43 mm
- weight: 70 g/105 g
- packaging: 1 pc, paper blister



**P3539** 1/-/6/24  
14 41 341 100 P3539

- source of light: LED + COB LED (green, red)
- maximal light output: 220 lm
- maximal beam distance: 100 m
- number of lighting modes: 7
- runtime: 45-160 hrs
- focus: no
- reflective head strap
- impact resistance
- waterproof: yes (IP43)

- charging: no
- power supply: 3× AAA
- battery type: LR03 (1.5 V)
- batteries included: no
- special function: quick switch ON/OFF
- dimensions: 65 × 45 × 50 mm
- weight: 65 g/100 g
- packaging: 1 pc, paper blister



**P3536** 1/-/6/24  
14 41 263 110 E-HL117

- source of light: COB LED (white, red)
- maximal light output: 125 lm
- maximal beam distance: 20 m
- number of lighting modes: 3
- runtime: 9-19 hrs
- focus: no
- reflective head strap: no
- impact resistance
- waterproof: yes (IP44)

- charging: no
- power supply: 3× AAA
- battery type: LR03 (1.5 V)
- batteries included: no
- special function: battery protection
- dimensions: 69 × 43 × 46 mm
- weight: 54 g/89 g
- packaging: 1 pc, paper blister



**P3532** 1/-/6/24  
14 41 233 120 E-923

- source of light: COB LED
- maximal light output: 150 lm
- maximal beam distance: 20 m
- number of lighting modes: 3
- runtime: 8-27 hrs
- focus: no
- reflective head strap
- impact resistance
- waterproof: no

- charging: no
- power supply: 3× AAA
- battery type: LR03 (1.5 V)
- batteries included: no
- dimensions: 60 × 40 × 40 mm
- weight: 53 g/88 g
- packaging: 1 pc, paper blister



**P3528** 1/-/6/24  
14 41 203 100 E-1450



www.emos.eu

Order Code  
Item Number

Packaging  
Type

- source of light: LED + 2× red LED
- maximal light output: 85 lm
- maximal beam distance: 65 m
- number of lighting modes: 4
- runtime: 50–120 hrs
- focus: no
- reflective head strap
- impact resistance
- waterproof: yes (IP43)

- charging: no
- power supply: 3× AAA
- battery type: LR03 (1.5 V)
- batteries included: no
- special function: quick switch ON/OFF
- dimensions: 58 × 38 × 44 mm
- weight: 54 g/89 g
- packaging: 1 pc, paper blister



**P3521** 1/-/8/32  
14 41 162 100 HL-H0520

- source of light: COB LED
- maximal light output: 110 lm
- maximal beam distance: 15 m
- number of lighting modes: 3
- runtime: 20–40 hrs
- focus: no
- reflective head strap: no
- impact resistance
- waterproof: no

- charging: no
- power supply: 3× AAA
- battery type: LR03 (1.5 V)
- batteries included: no
- dimensions: 60 × 18 × 40 mm
- weight: 21 g/56 g
- packaging: 1 pc, paper blister



**P3537** 1/-/12/48  
14 41 273 110 E-HL120

- source of light: 3× LED
- maximal light output: 12 lm
- maximal beam distance: 12 m
- number of lighting modes: 3
- runtime: 55 hrs
- focus: no
- reflective head strap
- impact resistance
- waterproof: yes (IP44)

- charging: no
- power supply: 2× CR2032
- batteries included
- weight: 47 g
- packaging: 8 pcs, display box



**P3540** 8/-/8/24  
14 41 212 901 P3540

- source of light: COB LED + LED
- maximal light output: 500 lm
- maximal beam distance: 130 m
- number of lighting modes: 7
- runtime: 4–6.5 hrs
- focus: no
- reflective head strap
- impact resistance
- waterproof: yes (IP44)

- charging
- power supply: Li-pol
- battery type: 1 200 mAh/3.7 V
- batteries included
- special function: hand-operated switching, quick swi
- accessories: USB-C cable
- dimensions: 70 × 45 × 35 mm
- weight: 90 g
- packaging: 1 pc, small paper box



**P3542** 1/-/6/24  
14 41 317 000 P3542

# EMOS

## LED Work Lights

### LED Rechargeable Work Lights

- with quality SMD/COB LED chips, lights the whole workspace
- adapter for standard socket or car, some types also feature a power bank function
- adjustable body and numerous magnets and hooks for easy work
- reinforced ABS plastic – withstands most impacts and falls
- selected models are equipped with a powerbank function

- source of light: COB LED cold + COB LED warm
- maximal light output: 900 lm
- maximal beam distance: 35 m
- number of lighting modes: 16
- runtime: 3,5–12,5 h
- impact resistance
- rechargeable
- battery: Li-Ion
- battery type: 4 400 mAh/3.7 V

- batteries included
- recharge time: 4.5 hrs
- power connector type: USB C
- features: magnet, rotating stand, hook
- dimensions: 125 × 45 × 95 mm
- weight: 325 g
- packaging: 1 pc, box



**P4542** 1/-/-/12  
14 50 000 420 P4542

- source of light: COB LED
- maximal light output: 1 200 lm
- maximal beam distance: 60 m
- number of lighting modes: 3
- runtime: 3.5–6.5 hrs
- impact resistance
- waterproof: yes (IP44)
- rechargeable
- battery: Li-pol

- battery type: 2 000 mAh/3.7 V
- batteries included
- recharge time: 3 hrs
- power connector type: USB C
- features: magnet, stand, clip
- dimensions: 80 × 45 × 80 mm
- weight: 160 g
- packaging: 1 pc, box



**P4543** 1/-/-/12  
14 50 000 430 P4543

- source of light: 2× COB LED
- maximal light output: 2 000 lm
- maximal beam distance: 70 m
- number of lighting modes: 5
- runtime: 3.5–14.5 hrs
- impact resistance
- waterproof: no
- rechargeable
- battery: Li-Ion accumulator

- battery type: 8 000 mAh/3.7 V
- batteries included
- recharge time: 7 hrs
- power connector type: USB C
- features: swivel handle, 4× magnet
- dimensions: 214 × 140 (280) × 56 mm
- weight: 818 g
- packaging: 1 pc, box



**P4536** 1/-/4/8  
14 50 000 320 E-17172





www.emos.eu

Order Code  
Item Number

Packaging  
Type

- source of light: COB LED
- maximal light output: 1 000 lm
- maximal beam distance: 45 m
- number of lighting modes: 3
- runtime: 3.5-15.5 hrs
- impact resistance
- waterproof: yes (IP44)
- rechargeable
- battery: Li-Ion accumulator

- battery type: 4 400 mAh/3.7 V
- batteries included
- recharge time: 7.5 hrs
- power connector type: micro USB B
- features: swivel handle
- dimensions: 172 × 45 × 126 mm
- weight: 453 g
- packaging: 1 pc, box



COB 1 000 lm 45 m Water resistance Rechargeable PowerBank 3 lighting modes 3 YEARS WARRANTY 8 592920 075807

**P4533** 1/-/-/10  
14 50 000 300 E-5145

- source of light: COB LED
- maximal light output: 600 lm
- maximal beam distance: 35 m
- number of lighting modes: 2
- runtime: 2.5-3.5 hrs
- impact resistance
- waterproof: yes (IP44)
- rechargeable
- battery: Li-Ion accumulator

- battery type: 3 000 mAh/3.7 V
- batteries included
- recharge time: 3.5 hrs
- power connector type: micro USB B
- features: swivel handle
- dimensions: 172 × 45 × 126 mm
- weight: 436 g
- packaging: 1 pc, box



COB 600 lm 35 m Water resistance Rechargeable PowerBank 2 lighting modes 8 592920 077658

**P4534** 1/-/-/10  
14 50 000 310 E1204

- source of light: COB LED
- maximal light output: 1 000 lm
- maximal beam distance: 40 m
- number of lighting modes: 3
- runtime: 3-17 hrs
- impact resistance
- waterproof: yes (IP44)
- rechargeable
- battery: Li-Ion

- battery type: 2 200 mAh/3.7 V
- batteries included
- recharge time: 3 hrs
- power connector type: USB C
- features: magnet, stand, clip
- dimensions: 104 × 39 × 94 mm
- packaging: 1 pc, box



COB 1 000 lm 40 m Water resistance Rechargeable PowerBank 3 lighting modes 8 592920 108031

**P4539** 1/-/-/10  
14 50 000 390 P4539

- source of light: COB LED + SMD LED
- maximal light output: 750 lm
- maximal beam distance: 35 m
- number of lighting modes: 6
- runtime: 2-13 h
- impact resistance
- waterproof: yes (IP44)
- rechargeable
- battery: Li-Ion

- battery type: 2 000 mAh/3.7 V
- batteries included
- recharge time: 2,5 h
- power connector type: USB C
- features: rotating reflector, magnet, hook
- dimensions: 28 × 35 × 147/285 mm
- weight: 118 g
- packaging: 1 pc, box



COB + LED 750 lm 100 m Water resistance Rechargeable 6 lighting modes 8 592920 128961

**P4540** 1/-/5/25  
14 50 000 291 P4540

- source of light: COB LED + LED
- maximal light output: 450 lm
- maximal beam distance: 100 m
- number of lighting modes: 3
- runtime: 7-16 h
- impact resistance
- waterproof: yes (IP44)
- rechargeable
- battery: Li-Ion

- battery type: 2 000 mAh/3.7 V
- batteries included
- recharge time: 3.5 hrs
- power connector type: USB C
- features: magnet, hook
- dimensions: 43 × 43 × 197 mm
- weight: 190 g
- packaging: 1 pc, box



COB + LED 450 lm 100 m Water resistance Rechargeable 2 lighting modes 8 592920 128763

**P4541** 1/-/4/12  
14 50 000 292 P4541



www.emos.eu

Order Code  
Item Number

Packaging  
Type

- source of light: COB LED + LED
- maximal light output: 470 lm
- maximal beam distance: 45 m
- number of lighting modes: 3
- runtime: 2.5-8 hrs
- impact resistance
- waterproof: no
- rechargeable
- battery: Li-Ion accumulator

- battery type: 1 800 mAh/3.7 V
- batteries included
- recharge time: 3.5 hrs
- features: swivel handle, clip, 1× hook, 2× magnet
- dimensions: 52 × 41 × 242 mm
- weight: 256 g
- packaging: 1 pc, box



**P4532**  
14 50 000 290

1/-/-16  
E-7712

- source of light: COB LED + 5× LED
- maximal light output: 500 lm
- maximal beam distance: 30 m
- number of lighting modes: 3
- runtime: 2-26 hrs
- impact resistance
- waterproof: yes (IP43)
- rechargeable
- battery: Li-Ion accumulator

- battery type: 2 000 mAh/3.7 V
- batteries included
- recharge time: 3 hrs
- power connector type: 3.0 × 1.0/12 mm
- features: swivel handle, 1× hook, 3× magnet
- dimensions: 76 × 66 × 317 mm
- weight: 537 g
- packaging: 1 pc, box



**P4525**  
14 50 000 240

1/-/-12  
E708A-COB+5

- source of light: COB LED + LED
- maximal light output: 380 lm
- maximal beam distance: 27 m
- number of lighting modes: 3
- runtime: 3.5-24 hrs
- impact resistance
- waterproof: yes (IP43)
- rechargeable
- battery: Li-Ion accumulator

- battery type: 2 500 mAh/3.7 V
- batteries included
- recharge time: 4 hrs
- power connector type: -
- features: swivel handle, 1× hook, 2× magnet
- dimensions: 56 × 50 × 240 mm
- weight: 265 g
- packaging: 1 pc, box



**P4518**  
14 50 000 180

1/-/6/12  
E709A-COB3W+6

- source of light: 2× COB LED + LED
- maximal light output: 670 lm
- maximal beam distance: 40 m
- number of lighting modes: 3
- runtime: 2-10 hrs
- impact resistance: no
- waterproof: no
- rechargeable
- battery: Li-Ion accumulator

- battery type: 2 200 mAh/3.7 V
- batteries included
- recharge time: 3 hrs
- power connector type: USB C
- features: 1× hook, 4× magnet
- dimensions: 35 × 33 × 257 mm
- packaging: 1 pc, box



**P4535**  
14 40 004 901

1/-/8/16  
E719AU

- source of light: COB LED + LED
- maximal light output: 400 lm
- maximal beam distance: 40 m
- number of lighting modes: 3
- runtime: 3-8.5 hrs
- impact resistance
- waterproof: yes (IP43)
- rechargeable
- battery: Li-Ion accumulator

- battery type: 2 000 mAh/3.7 V
- batteries included
- recharge time: 3 hrs
- power connector type: USB C
- features: swivel handle, clip, 1× hook, 1× magnet
- dimensions: 52 × 32 × 165 mm
- weight: 196 g
- packaging: 1 pc, box



**P4531**  
14 50 000 280

1/-/8/32  
E-17191 (P4531)



www.emos.eu

Order Code  
Item Number

Packaging  
Type

- source of light: SMD LED + LED
- maximal light output: 700 lm
- maximal beam distance: 45 m
- number of lighting modes: 3
- runtime: 3-6 hrs
- impact resistance: no
- waterproof: no
- rechargeable
- battery: Li-Ion

- battery type: 1 200 mAh/3.7 V
- batteries included
- recharge time: 2 hrs
- power connector type: USB C
- features: 2× magnet
- dimensions: 37 × 14 × 240 mm
- weight: 100 g
- packaging: 1 pc, box



3 lighting modes



**P4538**

1/-/6/24

14 50 000 360

P4538

- source of light: COB LED + SMD LED
- maximal light output: 330 lm
- maximal beam distance: 45 m
- number of lighting modes: 3
- runtime: 3-7 hrs
- impact resistance
- waterproof: yes (IP43)
- rechargeable
- battery: Li-Ion

- battery type: 1 200 mAh/3.7 V
- batteries included
- recharge time: 2-4 hrs
- power connector type: USB C
- features: swivel handle, 1× clip, 1× magnet, 1× hook
- dimensions: 41 × 29 × 154 mm
- weight: 110 g
- packaging: 1 pc, box



3 lighting modes



**P4537**

1/-/12/24

14 50 000 350

P4537

## LED Work Lights

- fitted with quality COB LED chips – lights a large workspace
- small and light – just right for the hand
- powered by AA or AAA batteries
- adjustable body and numerous magnets and hooks for easy work
- reinforced ABS plastic – withstands most impacts and falls
- long run time

- source of light: COB LED
- maximal light output: 700 lm
- maximal beam distance: 35 m
- number of lighting modes: 3
- runtime: 8-14 hrs
- impact resistance
- waterproof: yes (IP43)
- rechargeable: no
- battery: 4× AA

- battery type: LR6 (1,5 V)
- batteries included: no
- features: swivel handle
- dimensions: 145 × 105 × 35 mm
- weight: 165 g
- packaging: 1 pc, small paper box



3 lighting modes



**P4113**

1/-/-/14

14 40 814 200

P4113

- source of light: 2× COB LED + LED
- maximal light output: 350 lm
- maximal beam distance: 110 m
- number of lighting modes: 2
- runtime: 10-20 hrs
- waterproof: no
- rechargeable: no
- battery: 3× AA
- battery type: LR6 (1,5 V)

- batteries included: no
- features: swivel handle
- dimensions: 135 × 100 × 40 mm
- weight: 140 g
- packaging: 1 pc, small paper box



2 lighting modes



**P4112**

1/-/-/14

14 40 833 200

P4112



www.emos.eu

Order Code  
Item Number

Packaging  
Type

- source of light: COB LED
- maximal light output: 180 lm
- maximal beam distance: 45 m
- number of lighting modes: 2
- runtime: 16-24 hrs
- impact resistance
- waterproof: no
- rechargeable: no
- battery: 3× AAA
- battery type: LR03 (1.5 V)
- batteries included: no
- features: break-over handle, 1× hook, 2× magnet
- dimensions: 59 × 30 × 133 mm
- weight: 110 g
- packaging: 1 pc, blister



**P3888** 1/-/12/24  
14 40 813 100 E-6166

## LED Work Lights – 230 V

- powered from standard socket (230 V)
- long lead-in cable – 5 m
- fitted with hooks for hanging

- power source: 230 V~/50 Hz
- source of light: 20× LED 0,2 W (360 lm)
- type of cable: H05RN-F 2× 1.0 mm<sup>2</sup> rubber
- cable length: 5 m
- IP rating: IP20
- dimensions: 35 × 470 mm
- packaging: 1 pc, hanging



**P4205** 1/-/-/30  
14 49 000 050 E-A-5LP

- power source: 230 V~/50 Hz
- source of light: bulb 60 W max. (not included)
- type of cable: H05RN-F 2× 1.0 mm<sup>2</sup> rubber
- cable length: 5 m
- IP rating: IP20
- dimensions: 110 × 390 mm
- packaging: 1 pc, hanging



**P4203** 1/-/-/24  
14 49 000 030 DY-YJD-A-8P  
(DY-YJD-A-8)



# EMOS

## LED Rechargeable flashlights EXPERT

- torches with high luminous efficiency and long range
- most models fitted with top quality OSRAM or CREE LED chips
- last more than 70 hours on one charging, various light modes
- pack contains classic power adapter and car adapter
- made of reinforced ABS plastic resistant to falls

- source of light: OSRAM LED
- maximal light output: 300 lm
- maximal beam distance: 370 m
- number of lighting modes: 2
- runtime: 24–30 hrs
- impact resistance: no
- waterproof: no
- rechargeable
- battery: Li-Ion accumulator

- battery type: 2 400 mAh/3.7 V
- batteries included
- recharge time: 4.5 hrs
- dimensions: 162 × 100 × 140 mm
- weight: 275 g
- packaging: 1 pc, box



**P2311**

1/-/-10

14 50 000 370

P2311



- source of light: OSRAM LED
- maximal light output: 750 lm
- maximal beam distance: 470 m
- number of lighting modes: 3
- runtime: 15–30 hrs
- impact resistance: no
- waterproof: no
- rechargeable
- battery: Li-Ion accumulator

- battery type: 4 000 mAh/3.7 V
- batteries included
- recharge time: 6.5 h
- power connector type: micro USB B
- dimensions: 212 × 150 × 155 mm
- weight: 527 g
- packaging: 1 pc, box



**P2312**

1/-/-4

14 50 000 380

P2312



- source of light: SMD LED + LED
- maximal light output: 350 lm
- maximal beam distance: 260 m
- number of lighting modes: 7
- runtime: 5–23 hrs
- impact resistance
- waterproof
- rechargeable
- battery: Li-Ion accumulator

- battery type: 2× 2 000 mAh/3.7 V
- batteries included
- recharge time: 7 hrs
- power connector type: USB C
- features: swivel handle, 1× hook, 3× magnet
- dimensions: 175 × 91 mm
- weight: 406 g
- packaging: 1 pc, box



**P2313**

1/-/-12

14 50 000 400

P2313



# LED Bike Lights

- front (white) and rear (red) bike lights with efficient LEDs
- consume little energy despite high luminous efficiency
- water-resistant and impact-resistant from 1 m
- bike mount included

- source of light: LED/SMD LED
- maximal light output: 90 lm
- maximal beam distance: 35 m
- number of lighting modes: 3/4
- runtime: 2-5 hrs
- impact resistance: no
- waterproof: no
- rechargeable
- battery: Li-pol

- battery type: 500 mAh/3.7 V
- batteries included
- recharge time: 1 h
- power connector type: micro USB B
- dimensions: 27 × 27 × 65 mm/71 × 21 × 18 mm
- weight: 34/25 g
- packaging: 1 pc, blister



**P3923** 1/-/5/20  
14 46 002 300 P3923

- source of light: LED (front), 3× LED (back)
- maximal light output: 150 lm
- maximal beam distance: 110 m
- number of lighting modes: 10
- runtime: 96-172 hrs
- waterproof: yes (IP43)
- rechargeable: no
- battery: front: 3× AAA, back: 2× AAA
- battery type: LR03 (1.5 V)

- batteries included: no
- dimensions: 28 × 103 mm, 30 × 65 × 40 mm
- packaging: 1 pc, blister



**P3920** 1/-/5/20  
14 46 002 000 E-3219

- source of light: COB LED white, COB LED red
- maximal light output: 22 lm
- maximal beam distance: 7 m
- number of lighting modes: 2
- runtime: 80 hrs
- impact resistance
- waterproof: yes (IP43)
- rechargeable: no
- battery: 2× 2 CR2032

- battery type: CR2032 (3 V)
- batteries included
- dimensions: 61 × 17 × 32 mm
- packaging: 1 pc, blister



**P3922** 1/-/6/12  
14 46 002 200 E-8068

- source of light: 2× LED white, 2× LED red
- maximal light output: 10 lm
- maximal beam distance: 13 m
- number of lighting modes: 3
- runtime: 140 hrs
- impact resistance
- waterproof: yes (IP43)
- rechargeable: no
- battery: 2× 2 CR2032

- battery type: CR2032 (3 V)
- batteries included
- dimensions: 90 × 29 × 25 mm
- packaging: 1 pc, blister



**P3921** 1/-/6/36  
14 46 002 100 E-8075 (P3921)

# EMOS

## LED Night Lights

### LED Battery Night Lights

- better orientation in the dark for both children and adults
- powered by AA or AAA batteries
- smart solution for places without power (attic or cabinet)
- with switch, photosensor (day/night) or PIR sensor
- very low power consumption; run time: 41–100 hours

- source of light: 8× LED 5 mm in diameter
- light color: cool white
- power source: 3× 1.5 V AA
- switch
- automatic on/off
- photosensor
- motion sensor
- time delay: 25 seconds +/- 5 seconds
- dimensions: 90 × 37 mm

▪ packaging: 1 pc, blister



**P3310K** 1/-/4/16  
14 40 883 200 E-84001

- source of light: COB LED
- light color: cool white
- power source: 3× 1.5 V AA
- switch
- automatic on/off
- photosensor
- motion sensor
- time delay: 25 seconds +/- 5 seconds
- rotation: 360°

▪ dimensions: 85 × 96 × 119 mm  
▪ packaging: 1 pc, box



**P3311** 1/-/-/16  
14 40 004 902 E-XGCL-08MC

- source of light: 3× LED 5 mm in diameter
- light color: cool white
- power source: 3× 1.5 V AAA (included)
- switch
- motion sensor: no
- dimensions: 65 × 23 × 65 mm
- packaging: 3 pcs, blister



**P3819** 3/-/12/36  
14 40 033 100 P3819



- source of light: SMD LED
- maximal light output: 35 lm
- maximal beam distance: 22 m
- number of lighting modes: 1
- runtime: 90 hrs
- impact resistance
- waterproof: no
- rechargeable: no
- battery: 3× AAA
- battery type: LR03 (1.5 V)
- batteries included: no
- dimensions: 108 × 148 mm
- weight: 195 g
- packaging: 1 pc, box



**P3380** 1/-/4/8  
14 40 013 124 P3380

## LED 230 V Night Lights

- better orientation in the dark for both children and adults
- very low power consumption
- socket-powered – comfortable and eco-friendly (no batteries)
- selected models with passthrough socket
- with switch, photosensor (day/night) or PIR sensor

- source of light: LED
- light color: cool white
- power source: 230 V~/50 Hz, max. 0.5 W
- automatic on/off
- photosensor
- motion sensor: no
- dimensions: 46 × 67 × 46 mm
- packaging: 1 pc, blister



**P3306** 1/4/-/36  
14 56 000 060 EMN100

- source of light: 1× LED 5 mm in diameter
- light color: cool white
- power source: 230 V~/50 Hz, max. 0,3 W
- switch
- automatic on/off
- photosensor
- motion sensor: no
- dimensions: 60 × 60 × 73 mm
- packaging: 1 pc, blister



**P3313** 1/-/4/16  
14 56 000 100 P3313

- source of light: LED
- light color: warm white
- power source: 230 V~/50 Hz
- automatic on/off
- photosensor
- motion sensor: no
- dimensions: 51 × 56 × 51 mm
- packaging: 1 pc, blister



**P3314** 1/-/-/20  
14 56 000 110 P3314





- source of light: LED
- light color: warm white
- power source: 230 V~/50 Hz
- automatic on/off
- photosensor
- motion sensor: no
- dimensions: 63 × 57 × 63 mm
- packaging: 1 pc, blister



**P3315** 1/-/-/20  
14 56 000 120 P3315

- source of light: LED
- light color: warm white
- power source: 230 V~/50 Hz
- switch
- automatic on/off
- photosensor
- motion sensor: no
- dimensions: 76 × 54 × 76 mm
- packaging: 1 pc, blister



**P3316** 1/-/-/15  
14 56 000 130 P3316

- source of light: LED
- light color: warm white
- power source: 230 V~/50 Hz
- switch
- automatic on/off
- photosensor
- motion sensor: no
- dimensions: 87 × 63 × 87 mm
- packaging: 1 pc, blister



**P3317** 1/-/-/10  
14 56 000 140 P3317

- source of light: LED
- light color: warm white
- power source: 230 V
- automatic on/off
- photosensor
- motion sensor
- time delay: 90 seconds +/- 3 seconds
- dimensions: 55 × 80 × 102 mm
- packaging: 1 pc, paper blister



**P3318** 1/-/-/12  
14 56 000 150 P3318

- source of light: SMD LED
  - light color: warm white
  - power source: 230 V
  - switch
  - automatic on/off
  - photosensor
  - motion sensor
  - time delay: 30/60/120 seconds
  - dimensions: 74 × 54 × 80 mm
- packaging: 1 pc, paper blister



**P3319** 1/-/-/15  
14 56 000 160 P3319



- source of light: LED
- light color: warm white
- power source: 230 V~/50 Hz
- automatic on/off
- photosensor
- motion sensor: no
- dimensions: 79 × 66 × 79 mm
- packaging: 1 pc, blister



**P3320** 1/-/3/18  
14 56 000 170 P3320

## EMOS

### LED Flashlights display box

- made of aluminium or reinforced ABS plastic
- always at hand: in the pocket, tool case or the car
- batteries included
- flashlights with maximum beam distance to 150 m
- run time up to 128 hours

- source of light: COB LED
- maximal light output: 110 lm
- maximal beam distance: 15 m
- number of lighting modes: 3
- runtime: 20–40 hrs
- focus: no
- reflective head strap: no
- impact resistance
- waterproof: no

- charging: no
- power supply: 3× AAA
- battery type: LR03 (1.5 V)
- batteries included
- dimensions: 60 × 18 × 40 mm
- weight: 21 g/56 g
- packaging: 12 pcs, display box



**P3538** 12/-/12/60  
14 41 283 110 E-HL120

- source of light: COB LED + 3× LED
- maximal light output: 200 lm
- maximal beam distance: 17 m
- number of lighting modes: 2
- runtime: 25–128 hrs
- impact resistance
- waterproof: no
- rechargeable: no
- battery: 3× AAA

- battery type: LR03 (1.5 V)
- batteries included
- features: 1× hook, 1× magnet
- dimensions: 94 × 34 × 64 mm
- weight: 105 g
- packaging: 12 pcs, display box



**P3889** 12/-/12/60  
14 40 833 100 E-6113



- source of light: COB LED + LED
- maximal light output: 230 lm
- maximal beam distance: 80 m
- number of lighting modes: 2
- runtime: 47-72 hrs
- impact resistance
- waterproof: no
- rechargeable: no
- battery: 3× AAA

- battery type: LR03 (1.5 V)
- batteries included
- features: clip
- dimensions: 168 × 29 × 26 mm
- weight: 64 g
- packaging: 16 pcs, display box



**P3897** 16/-/16/64  
14 40 813 130 P3897

- source of light: LED
- maximal light output: 75 lm
- maximal beam distance: 125 m
- number of lighting modes: 1
- runtime: 15 hrs
- focus
- impact resistance
- waterproof: yes (IP43)
- rechargeable: no

- battery: 3× AAA
- battery type: LR03 (1.5 V)
- batteries included
- features: hand strap
- dimensions: 120 × 35 × 35 mm
- weight: 83 g
- packaging: 12 pcs, display box



**P4703** 12/-/12/96  
14 40 013 115 E-1512

- source of light: COB LED
- maximal light output: 100 lm
- maximal beam distance: 20 m
- number of lighting modes: 1
- runtime: 28 hrs
- impact resistance
- waterproof: yes (IP43)
- rechargeable: no
- battery: 3× AAA

- battery type: LR03 (1.5 V)
- batteries included
- features: hand strap
- dimensions: 102 × 28 × 28 mm
- packaging: 12 pcs, display box



**P4705** 12/-/12/96  
14 40 813 160 E-2217

- source of light: 9× LED
- maximal light output: 50 lm
- maximal beam distance: 22 m
- number of lighting modes: 1
- runtime: 30 hrs
- impact resistance
- rechargeable: no
- battery: 3× AAA
- battery type: LR03 (1.5 V)

- batteries included
- dimensions: 88 × 26 × 26 mm
- weight: 71 g
- packaging: 24 pcs, display box



**P3848A** 24/-/24/96  
14 40 093 109 LFL215-9T

- source of light: COB LED
- maximal light output: 100 lm
- maximal beam distance: 12 m
- number of lighting modes: 1
- runtime: 25 hrs
- impact resistance
- waterproof: no
- rechargeable: no
- battery: 3× AAA

- battery type: LR03 (1.5 V)
- batteries included
- features: hand strap
- dimensions: 100 × 29 × 29 mm
- weight: 34 g
- packaging: 12 pcs, display box



**P4706** 12/-/12/96  
14 40 013 116 E2910-C



- source of light: COB LED
- maximal light output: 30 lm
- maximal beam distance: 8 m
- number of lighting modes: 4
- runtime: 3.5-60 hrs
- rechargeable: no
- battery: 2× AAA
- battery type: LR03 (1.5 V)
- batteries included

- dimensions: 63 × 25 × 35 mm
- weight: 38 g
- packaging: 12 pcs, display box



**P3887** 12/-/12/72  
14 40 812 900 E-3205

- source of light: COB LED
- maximal light output: 350 lm
- maximal beam distance: 25 m
- number of lighting modes: 1
- runtime: 4 hrs
- impact resistance: no
- waterproof: no
- rechargeable: no
- battery: 3× AAA

- battery type: LR03 (1.5 V)
- batteries included
- features: clip, 1× magnet
- dimensions: 42 × 118 × 30 mm
- weight: 48 g
- packaging: 12 pcs, display box



**P4715** 12/-/12/36  
14 40 113 100 P4715

- source of light: LED
- maximal light output: 10 lm
- number of lighting modes: 2
- runtime: 160 hrs
- impact resistance
- waterproof: yes (IP43)
- rechargeable: no
- battery: 2× CR2032
- battery type: CR2032 (3 V)

- batteries included
- features: arm band
- dimensions: 190 × 35 × 17 mm
- weight: 44 g
- packaging: 16 pcs, display box



**P4713** 16/-/16/32  
14 40 812 903 P4713

- source of light: COB LED
- maximal light output: 750 lm
- maximal beam distance: 40 m
- number of lighting modes: 7
- runtime: 45 min - 2 h
- impact resistance
- waterproof: yes (IP44)
- rechargeable
- battery: Li-pol

- battery type: 500 mAh/3.7 V
- batteries included
- recharge time: 1 h
- power connector type: USB C
- features: clip, 1× magnet, rotary stand, bottle opener
- dimensions: 61 × 45 × 21 mm
- weight: 37 g
- packaging: 10 pcs, display box



**P4714** 10/-/10/40  
14 50 000 410 P4714



# LED Keychains display box

- cute LED keychains for children
- different designs and motives
- some also make a sound when lit up
- powered by 3 button batteries (included)

- source of light: LED
- maximal light output: 5 lm
- number of lighting modes: 1
- rechargeable: no
- battery: 3× 1.5 V LR54
- battery type: LR54 (1.5 V)
- batteries included
- packaging: 24 pcs, display box



**P4712**

24/-/24/96

14 39 013 901

E-1321; E-1322;  
E-1323; E-1324

- source of light: LED
- maximal light output: 5 lm
- number of lighting modes: 1
- rechargeable: no
- battery: 3× 1.5 V LR54
- battery type: LR54 (1.5 V)
- batteries included
- packaging: 24 pcs, display box



**P4711**

24/-/24/96

14 39 013 900

E-1325; E-1326;  
E-1327; E-1328

- source of light: 1× LED
- maximal light output: 5 lm
- number of lighting modes: 1
- impact resistance: no
- waterproof: no
- rechargeable: no
- battery: 3× LR54
- battery type: LR54 (1.5 V)
- batteries included

▪ packaging: 24 pcs, display box



**P4710**

24/-/24/96

14 39 011 900

E-1317; E-1318;  
E-1319; E-1320

## Insect killer

- electric trap for reliable protection from pesky insects
- 1 m lead-in cable

- source of light: UV-A LED tube
- number of lighting modes: 1
- battery: 220-240 V~/50 Hz
- features: hand strap
- dimensions: 136 × 240 mm
- packaging: 1 pc, box



8 592920 131466

**P4104**

1/-/-/6

14 48 000 040

P4104

## Spare parts

- primarily as accessory to rechargeable LED torches
- socket adapters
- maintenance-free lead-acid accumulators
- switches

**V94420**

1/-/-/90

16 06 022 000

LG060030EP  
(LGSPSA060030E)



8 595025 394460



input voltage: 230 V~, 50/60 Hz = designed for: 3810. 3 W (P2306) lamp = output voltage: 6 V= = output current: 300 mA = size of the connector: 5.5 × 2.5/9.5 mm = power supply type: cable with DC connector = dimensions: 71 × 42 × 55 mm = packaging: 1 pc, box

**P2398**

1/-/-/500

14 33 010 008

3810LED



8 595025 366382



packaging: 1 pc

**P2399**

1/-/-/500

14 33 010 009

3810



8 595025 361141



packaging: 1 pc

**B9664**

1/-/-/20

12 01 001 800

DHB440



8 595025 394477



for lanterns: 3810 - 3 W (P2306), 3810-10 W (P2307) = chemical constitution: Pb = voltage: 4 V = capacity: 4 Ah = dimensions: 70 × 47 × 101 mm = packaging: 1 pc

# Lighting



## Light sources

### LED bulbs

### Filament

- maximum lighting efficiency with minimum energy consumption
- acts as a perfect replacement for tungsten filament bulbs
- instantly illuminates 100% at the flick of a switch
- high luminous efficacy up to 212 lm/W
- use: modern interiors, reception areas



- replacement of incandescent bulb: 60 W
- shape: A60
- luminous flux: 806 lm
- color temperature: 2 700 K
- power: 3.8 W
- luminous efficacy: 212 lm/W
- energy efficiency class: A
- beam angle: 360°
- color rendering index (CRI): Ra >80

- voltage: 230 V~/50 Hz
- dimensions: 60 × 60 × 108 mm
- packaging: 1 pc, small box



**ZF5147** 1/-/10/40  
15 25 283 273 EMOS

- replacement of incandescent bulb: 60 W
- shape: A60
- luminous flux: 806 lm
- color temperature: 2 700 K
- power: 3.8 W
- luminous efficacy: 212 lm/W
- energy efficiency class: A
- beam angle: 360°
- color rendering index (CRI): Ra >80

- voltage: 230 V~/50 Hz
- dimensions: 60 × 60 × 108 mm
- packaging: 3 pcs, small box



**ZF5147.3** 3/-/12/48  
15 25 283 274 EMOS

- = replacement of incandescent bulb: 60 W
- = shape: A60
- = luminous flux: 806 lm
- = color temperature: 4 000 K
- = power: 3.8 W
- = luminous efficacy: 212 lm/W
- = energy efficiency class: A
- = beam angle: 360°
- = color rendering index (CRI): Ra >80

- = voltage: 230 V~/50 Hz
- = dimensions: 60 × 60 × 108 mm
- = packaging: 1 pc, small box



**ZF5148** 1/-/10/40  
15 25 283 410 EMOS

- = replacement of incandescent bulb: 60 W
- = shape: A60
- = luminous flux: 806 lm
- = color temperature: 4 000 K
- = power: 3.8 W
- = luminous efficacy: 212 lm/W
- = energy efficiency class: A
- = beam angle: 360°
- = color rendering index (CRI): Ra >80

- = voltage: 230 V~/50 Hz
- = dimensions: 60 × 60 × 108 mm
- = packaging: 3 pcs, small box



**ZF5148.3** 3/-/12/48  
15 25 283 411 EMOS

- = replacement of incandescent bulb: 75 W
- = shape: A60
- = luminous flux: 1 060 lm
- = color temperature: 2 700 K
- = power: 5 W
- = luminous efficacy: 212 lm/W
- = energy efficiency class: A
- = beam angle: 360°
- = color rendering index (CRI): Ra >80

- = voltage: 230 V~/50 Hz
- = dimensions: 60 × 60 × 108 mm
- = packaging: 1 pc, small box



**ZF5157** 1/-/10/40  
15 25 283 275 EMOS

- = replacement of incandescent bulb: 75 W
- = shape: A60
- = luminous flux: 1 060 lm
- = color temperature: 2 700 K
- = power: 5 W
- = luminous efficacy: 212 lm/W
- = energy efficiency class: A
- = beam angle: 360°
- = color rendering index (CRI): Ra >80

- = voltage: 230 V~/50 Hz
- = dimensions: 60 × 60 × 108 mm
- = packaging: 3 pcs, small box



**ZF5157.3** 3/-/12/48  
15 25 283 276 EMOS

- = replacement of incandescent bulb: 75 W
- = shape: A60
- = luminous flux: 1 060 lm
- = color temperature: 4 000 K
- = power: 5 W
- = luminous efficacy: 212 lm/W
- = energy efficiency class: A
- = beam angle: 360°
- = color rendering index (CRI): Ra >80

- = voltage: 230 V~/50 Hz
- = dimensions: 60 × 60 × 108 mm
- = packaging: 1 pc, small box



**ZF5158** 1/-/10/40  
15 25 283 412 EMOS





www.emos.eu

Order Code  
Item Number

Packaging  
Type

- replacement of incandescent bulb: 75 W
- shape: A60
- luminous flux: 1 060 lm
- color temperature: 4 000 K
- power: 5 W
- luminous efficacy: 212 lm/W
- energy efficiency class: A
- beam angle: 360°
- color rendering index (CRI): Ra >80

- voltage: 230 V~/50 Hz
- dimensions: 60 × 60 × 108 mm
- packaging: 3 pcs, small box



**ZF5158.3** 3/-/12/48  
15 25 283 413 EMOS

- replacement of incandescent bulb: 100 W
- shape: A60
- luminous flux: 1 521 lm
- color temperature: 2 700 K
- power: 7.2 W
- luminous efficacy: 211 lm/W
- energy efficiency class: A
- beam angle: 360°
- color rendering index (CRI): Ra >80

- voltage: 230 V~/50 Hz
- dimensions: 60 × 60 × 108 mm
- packaging: 1 pc, small box



**ZF5167** 1/-/10/20  
15 25 283 279 ZF5167

- replacement of incandescent bulb: 100 W
- shape: A60
- luminous flux: 1 521 lm
- color temperature: 4 000 K
- power: 7.2 W
- luminous efficacy: 211 lm/W
- energy efficiency class: A
- beam angle: 360°
- color rendering index (CRI): Ra >80

- voltage: 230 V~/50 Hz
- dimensions: 60 × 60 × 108 mm
- packaging: 1 pc, small box



**ZF5168** 1/-/10/20  
15 25 283 417 ZF5168

- replacement of incandescent bulb: 75 W
- dimmable
- shape: A60
- luminous flux: 1 055 lm
- color temperature: 2 700 K
- power: 7.5 W
- luminous efficacy: 141 lm/W
- energy efficiency class: D
- beam angle: 320°

- color rendering index (CRI): Ra >80
- voltage: 230 V~/50 Hz
- dimensions: 60 × 60 × 106 mm
- packaging: 1 pc, small box



**ZF5154D** 1/-/10/40  
15 25 283 277 ZF5154D

- replacement of incandescent bulb: 75 W
- dimmable
- shape: A60
- luminous flux: 1 055 lm
- color temperature: 4 000 K
- power: 7.5 W
- luminous efficacy: 141 lm/W
- energy efficiency class: D
- beam angle: 320°

- color rendering index (CRI): Ra >80
- voltage: 230 V~/50 Hz
- dimensions: 60 × 60 × 106 mm
- packaging: 1 pc, small box



**ZF5254D** 1/-/10/40  
15 25 283 415 ZF5254D

- replacement of incandescent bulb: 100 W
- dimmable
- shape: A60
- luminous flux: 1 521 lm
- color temperature: 2 700 K
- power: 11 W
- luminous efficacy: 138 lm/W
- energy efficiency class: D
- beam angle: 320°

- color rendering index (CRI): Ra >80
- voltage: 230 V~/50 Hz
- dimensions: 60 × 60 × 108 mm
- packaging: 1 pc, small box



**ZF5164D** 1/-/10/20  
15 25 283 278 ZF5164D

- replacement of incandescent bulb: 100 W
- dimmable
- shape: A60
- luminous flux: 1 521 lm
- color temperature: 4 000 K
- power: 11 W
- luminous efficacy: 138 lm/W
- energy efficiency class: D
- beam angle: 320°

- color rendering index (CRI): Ra >80
- voltage: 230 V~/50 Hz
- dimensions: 60 × 60 × 108 mm
- packaging: 1 pc, small box



**ZF5264D** 1/-/10/20  
15 25 283 416 ZF5264D

- replacement of incandescent bulb: 40 W
- shape: A60
- luminous flux: 470 lm
- color temperature: 2 700 K
- power: 3.4 W
- luminous efficacy: 138 lm/W
- energy efficiency class: D
- beam angle: 360°
- color rendering index (CRI): Ra >80

- voltage: 230 V~/50 Hz
- dimensions: 108 × 60 × 60 mm
- packaging: 1 pc, small box



**ZF5D22** 1/-/10/20  
15 25 743 203 ZF5D22

- replacement of incandescent bulb: 40 W
- shape: A60
- luminous flux: 470 lm
- color temperature: 4 000 K
- power: 3.4 W
- luminous efficacy: 138 lm/W
- energy efficiency class: D
- beam angle: 360°
- color rendering index (CRI): Ra >80

- voltage: 230 V~/50 Hz
- dimensions: 108 × 60 × 60 mm
- packaging: 1 pc, small box



**ZF5D23** 1/-/10/20  
15 25 733 497 ZF5D23

- replacement of incandescent bulb: 60 W
- shape: A60
- luminous flux: 806 lm
- color temperature: 2 700 K
- power: 5.9 W
- luminous efficacy: 137 lm/W
- energy efficiency class: D
- beam angle: 360°
- color rendering index (CRI): Ra >80

- voltage: 230 V~/50 Hz
- dimensions: 108 × 60 × 60 mm
- packaging: 1 pc, small box



**ZF5D42** 1/-/10/20  
15 25 743 204 ZF5D42

- replacement of incandescent bulb: 60 W
- shape: A60
- luminous flux: 806 lm
- color temperature: 2 700 K
- power: 5.9 W
- luminous efficacy: 137 lm/W
- energy efficiency class: D
- beam angle: 360°
- color rendering index (CRI): Ra >80

- voltage: 230 V~/50 Hz
- dimensions: 108 × 60 × 60 mm
- packaging: 2 pcs, small box



**ZF5D42.2** 2/-/10/20  
15 25 743 207 ZF5D42.2

- replacement of incandescent bulb: 60 W
- shape: A60
- luminous flux: 806 lm
- color temperature: 4 000 K
- power: 5.9 W
- luminous efficacy: 137 lm/W
- energy efficiency class: D
- beam angle: 360°
- color rendering index (CRI): Ra >80

- voltage: 230 V~/50 Hz
- dimensions: 108 × 60 × 60 mm
- packaging: 1 pc, small box



**ZF5D43** 1/-/10/20  
15 25 733 498 ZF5D43

- replacement of incandescent bulb: 75 W
- shape: A60
- luminous flux: 1 060 lm
- color temperature: 2 700 K
- power: 7.8 W
- luminous efficacy: 136 lm/W
- energy efficiency class: D
- beam angle: 360°
- color rendering index (CRI): Ra >80

- voltage: 230 V~/50 Hz
- dimensions: 108 × 60 × 60 mm
- packaging: 1 pc, small box



**ZF5D52** 1/-/10/20  
15 25 743 205 ZF5D52

- replacement of incandescent bulb: 75 W
- shape: A60
- luminous flux: 1 060 lm
- color temperature: 4 000 K
- power: 7.8 W
- luminous efficacy: 136 lm/W
- energy efficiency class: D
- beam angle: 360°
- color rendering index (CRI): Ra >80

- voltage: 230 V~/50 Hz
- dimensions: 108 × 60 × 60 mm
- packaging: 1 pc, small box



**ZF5D53** 1/-/10/20  
15 25 733 499 ZF5D53

- replacement of incandescent bulb: 100 W
- shape: A60
- luminous flux: 1 521 lm
- color temperature: 2 700 K
- power: 10.5 W
- luminous efficacy: 145 lm/W
- energy efficiency class: D
- beam angle: 360°
- color rendering index (CRI): Ra >80

- voltage: 230 V~/50 Hz
- dimensions: 108 × 60 × 60 mm
- packaging: 1 pc, small box



**ZF5D62** 1/-/10/20  
15 25 743 206 ZF5D62

- replacement of incandescent bulb: 100 W
- shape: A60
- luminous flux: 1 521 lm
- color temperature: 4 000 K
- power: 10.5 W
- luminous efficacy: 145 lm/W
- energy efficiency class: D
- beam angle: 360°
- color rendering index (CRI): Ra >80

- voltage: 230 V~/50 Hz
- dimensions: 108 × 60 × 60 mm
- packaging: 1 pc, small box



**ZF5D63** 1/-/10/20  
15 25 743 400 ZF5D63

- replacement of incandescent bulb: 150 W
- shape: A70
- luminous flux: 2 452 lm
- color temperature: 2 700 K
- power: 18 W
- luminous efficacy: 136 lm/W
- energy efficiency class: D
- beam angle: 360°
- color rendering index (CRI): Ra >80

- voltage: 230 V~/50 Hz
- dimensions: 70 × 70 × 126 mm
- packaging: 1 pc, small box



**ZF5D82** 1/-/10/20  
15 25 743 208 ZF5D82

- replacement of incandescent bulb: 150 W
- shape: A70
- luminous flux: 2 452 lm
- color temperature: 4 000 K
- power: 18 W
- luminous efficacy: 136 lm/W
- energy efficiency class: D
- beam angle: 360°
- color rendering index (CRI): Ra >80

- voltage: 230 V~/50 Hz
- dimensions: 70 × 70 × 126 mm
- packaging: 1 pc, small box



**ZF5D83** 1/-/10/20  
15 25 743 401 ZF5D83

- replacement of incandescent bulb: 25 W
- shape: Mini Globe
- luminous flux: 250 lm
- color temperature: 2 700 K
- power: 1.8 W
- luminous efficacy: 139 lm/W
- energy efficiency class: D
- beam angle: 360°
- color rendering index (CRI): Ra >80

- voltage: 230 V~/50 Hz
- dimensions: 78 × 45 × 45 mm
- packaging: 1 pc, small box



**ZF6D02** 1/-/10/60  
15 25 743 209 ZF6D02

- replacement of incandescent bulb: 25 W
- shape: Mini Globe
- luminous flux: 250 lm
- color temperature: 4 000 K
- power: 1.8 W
- luminous efficacy: 139 lm/W
- energy efficiency class: D
- beam angle: 360°
- color rendering index (CRI): Ra >80

- voltage: 230 V~/50 Hz
- dimensions: 78 × 45 × 45 mm
- packaging: 1 pc, small box



**ZF6D03** 1/-/10/60  
15 25 743 402 ZF6D03



- replacement of incandescent bulb: 40 W
- shape: Mini Globe
- luminous flux: 470 lm
- color temperature: 2 700 K
- power: 3.4 W
- luminous efficacy: 138 lm/W
- energy efficiency class: D
- beam angle: 360°
- color rendering index (CRI): Ra >80

- voltage: 230 V~/50 Hz
- dimensions: 78 × 45 × 45 mm
- packaging: 1 pc, small box



**ZF6D22** 1/-/10/60  
15 25 743 210 ZF6D22

- replacement of incandescent bulb: 40 W
- shape: Mini Globe
- luminous flux: 470 lm
- color temperature: 4 000 K
- power: 3.4 W
- luminous efficacy: 138 lm/W
- energy efficiency class: D
- beam angle: 360°
- color rendering index (CRI): Ra >80

- voltage: 230 V~/50 Hz
- dimensions: 78 × 45 × 45 mm
- packaging: 1 pc, small box



**ZF6D23** 1/-/10/60  
15 25 743 403 ZF6D23

- replacement of incandescent bulb: 60 W
- shape: Mini Globe
- luminous flux: 806 lm
- color temperature: 2 700 K
- power: 5.9 W
- luminous efficacy: 137 lm/W
- energy efficiency class: D
- beam angle: 360°
- color rendering index (CRI): Ra >80

- voltage: 230 V~/50 Hz
- dimensions: 78 × 45 × 45 mm
- packaging: 1 pc, small box



**ZF6D42** 1/-/10/60  
15 25 743 211 ZF6D42

- replacement of incandescent bulb: 60 W
- shape: Mini Globe
- luminous flux: 806 lm
- color temperature: 4 000 K
- power: 5.9 W
- luminous efficacy: 137 lm/W
- energy efficiency class: D
- beam angle: 360°
- color rendering index (CRI): Ra >80

- voltage: 230 V~/50 Hz
- dimensions: 78 × 45 × 45 mm
- packaging: 1 pc, small box



**ZF6D43** 1/-/10/60  
15 25 743 404 ZF6D43

- replacement of incandescent bulb: 25 W
- shape: Mini Globe
- luminous flux: 250 lm
- color temperature: 2 700 K
- power: 1.8 W
- luminous efficacy: 139 lm/W
- energy efficiency class: D
- beam angle: 360°
- color rendering index (CRI): Ra >80

- voltage: 230 V~/50 Hz
- dimensions: 80 × 45 × 45 mm
- packaging: 1 pc, small box



**ZF1D02** 1/-/10/60  
15 25 731 251 ZF1D02

- replacement of incandescent bulb: 25 W
- shape: Mini Globe
- luminous flux: 250 lm
- color temperature: 4 000 K
- power: 1.8 W
- luminous efficacy: 139 lm/W
- energy efficiency class: D
- beam angle: 360°
- color rendering index (CRI): Ra >80

- voltage: 230 V~/50 Hz
- dimensions: 80 × 45 × 45 mm
- packaging: 1 pc, small box



**ZF1D03** 1/-/10/60  
15 25 731 448 ZF1D03

- replacement of incandescent bulb: 40 W
- shape: Mini Globe
- luminous flux: 470 lm
- color temperature: 2 700 K
- power: 3.4 W
- luminous efficacy: 138 lm/W
- energy efficiency class: D
- beam angle: 360°
- color rendering index (CRI): Ra >80

- voltage: 230 V~/50 Hz
- dimensions: 80 × 45 × 45 mm
- packaging: 1 pc, small box



**ZF1D22** 1/-/10/60  
15 25 731 252 ZF1D22

- replacement of incandescent bulb: 40 W
- shape: Mini Globe
- luminous flux: 470 lm
- color temperature: 4 000 K
- power: 3.4 W
- luminous efficacy: 138 lm/W
- energy efficiency class: D
- beam angle: 360°
- color rendering index (CRI): Ra >80

- voltage: 230 V~/50 Hz
- dimensions: 80 × 45 × 45 mm
- packaging: 1 pc, small box



**ZF1D23** 1/-/10/60  
15 25 731 449 ZF1D23

- replacement of incandescent bulb: 60 W
- shape: Mini Globe
- luminous flux: 806 lm
- color temperature: 2 700 K
- power: 5.9 W
- luminous efficacy: 137 lm/W
- energy efficiency class: D
- beam angle: 360°
- color rendering index (CRI): Ra >80

- voltage: 230 V~/50 Hz
- dimensions: 80 × 45 × 45 mm
- packaging: 1 pc, small box



**ZF1D42** 1/-/10/60  
15 25 731 253 ZF1D42

- replacement of incandescent bulb: 60 W
- shape: Mini Globe
- luminous flux: 806 lm
- color temperature: 4 000 K
- power: 5.9 W
- luminous efficacy: 137 lm/W
- energy efficiency class: D
- beam angle: 360°
- color rendering index (CRI): Ra >80

- voltage: 230 V~/50 Hz
- dimensions: 80 × 45 × 45 mm
- packaging: 1 pc, small box



**ZF1D43** 1/-/10/60  
15 25 731 450 ZF1D43

- replacement of incandescent bulb: 25 W
- shape: Candle
- luminous flux: 250 lm
- color temperature: 2 700 K
- power: 1.8 W
- luminous efficacy: 139 lm/W
- energy efficiency class: D
- beam angle: 360°
- color rendering index (CRI): Ra >80

- voltage: 230 V~/50 Hz
- dimensions: 35 × 35 × 97 mm
- packaging: 1 pc, small box



**ZF3D02** 1/-/10/40  
15 25 731 248 ZF3D02

- replacement of incandescent bulb: 25 W
- shape: Candle
- luminous flux: 250 lm
- color temperature: 4 000 K
- power: 1.8 W
- luminous efficacy: 139 lm/W
- energy efficiency class: D
- beam angle: 360°
- color rendering index (CRI): Ra >80

- voltage: 230 V~/50 Hz
- dimensions: 35 × 35 × 97 mm
- packaging: 1 pc, small box



**ZF3D03** 1/-/10/40  
15 25 731 445 ZF3D03

- replacement of incandescent bulb: 40 W
- shape: Candle
- luminous flux: 470 lm
- color temperature: 2 700 K
- power: 3.4 W
- luminous efficacy: 138 lm/W
- energy efficiency class: D
- beam angle: 360°
- color rendering index (CRI): Ra >80

- voltage: 230 V~/50 Hz
- dimensions: 35 × 35 × 97 mm
- packaging: 1 pc, small box



**ZF3D22** 1/-/10/40  
15 25 731 249 ZF3D22

- replacement of incandescent bulb: 40 W
- shape: Candle
- luminous flux: 470 lm
- color temperature: 4 000 K
- power: 3.4 W
- luminous efficacy: 138 lm/W
- energy efficiency class: D
- beam angle: 360°
- color rendering index (CRI): Ra >80

- voltage: 230 V~/50 Hz
- dimensions: 35 × 35 × 97 mm
- packaging: 1 pc, small box



**ZF3D23** 1/-/10/40  
15 25 731 446 ZF3D23

- replacement of incandescent bulb: 60 W
- shape: Candle
- luminous flux: 806 lm
- color temperature: 2 700 K
- power: 5.9 W
- luminous efficacy: 137 lm/W
- energy efficiency class: D
- beam angle: 360°
- color rendering index (CRI): Ra >80

- voltage: 230 V~/50 Hz
- dimensions: 35 × 35 × 97 mm
- packaging: 1 pc, small box



**ZF3D42** 1/-/10/40  
15 25 731 250 ZF3D42

- replacement of incandescent bulb: 60 W
- shape: Candle
- luminous flux: 806 lm
- color temperature: 4 000 K
- power: 5.9 W
- luminous efficacy: 137 lm/W
- energy efficiency class: D
- beam angle: 360°
- color rendering index (CRI): Ra >80

- voltage: 230 V~/50 Hz
- dimensions: 35 × 35 × 97 mm
- packaging: 1 pc, small box



**ZF3D43** 1/-/10/40  
15 25 731 447 ZF3D43

- replacement of incandescent bulb: 75 W
- shape: G95
- luminous flux: 1 055 lm
- color temperature: 2 700 K
- power: 7.8 W
- luminous efficacy: 135 lm/W
- energy efficiency class: D
- beam angle: 360°
- color rendering index (CRI): Ra >80

- voltage: 230 V~/50 Hz
- dimensions: 95 × 95 × 140 mm
- packaging: 1 pc, small box



**ZF2D52** 1/-/-/6  
15 25 743 212 ZF2D52

- replacement of incandescent bulb: 75 W
- shape: G95
- luminous flux: 1 055 lm
- color temperature: 4 000 K
- power: 7.8 W
- luminous efficacy: 135 lm/W
- energy efficiency class: D
- beam angle: 360°
- color rendering index (CRI): Ra >80

- voltage: 230 V~/50 Hz
- dimensions: 95 × 95 × 140 mm
- packaging: 1 pc, small box



**ZF2D53** 1/-/-/6  
15 25 743 405 ZF2D53

- replacement of incandescent bulb: 100 W
- shape: G125
- luminous flux: 1 521 lm
- color temperature: 2 700 K
- power: 11 W
- luminous efficacy: 138 lm/W
- energy efficiency class: D
- beam angle: 360°
- color rendering index (CRI): Ra >80

- voltage: 230 V~/50 Hz
- dimensions: 125 × 125 × 178 mm
- packaging: 1 pc, small box



**ZF2D62** 1/-/-/6  
15 25 743 213 ZF2D62

- replacement of incandescent bulb: 100 W
- shape: G125
- luminous flux: 1 521 lm
- color temperature: 4 000 K
- power: 11 W
- luminous efficacy: 138 lm/W
- energy efficiency class: D
- beam angle: 360°
- color rendering index (CRI): Ra >80

- voltage: 230 V~/50 Hz
- dimensions: 125 × 125 × 178 mm
- packaging: 1 pc, small box



**ZF2D63** 1/-/-/6  
15 25 743 406 ZF2D63



- replacement of incandescent bulb: 150 W
- shape: G125
- luminous flux: 2 452 lm
- color temperature: 2 700 K
- power: 18 W
- luminous efficacy: 136 lm/W
- energy efficiency class: D
- beam angle: 360°
- color rendering index (CRI): Ra >80

- voltage: 230 V~/50 Hz
- dimensions: 125 × 125 × 178 mm
- packaging: 1 pc, small box



**ZF2D82** 1/-/-/6  
15 25 743 214 ZF2D82

- replacement of incandescent bulb: 150 W
- shape: G125
- luminous flux: 2 452 lm
- color temperature: 4 000 K
- power: 18 W
- luminous efficacy: 136 lm/W
- energy efficiency class: D
- beam angle: 360°
- color rendering index (CRI): Ra >80

- voltage: 230 V~/50 Hz
- dimensions: 125 × 125 × 178 mm
- packaging: 1 pc, small box



**ZF2D83** 1/-/-/6  
15 25 743 407 ZF2D83

- replacement of incandescent bulb: 40 W
- shape: A60
- luminous flux: 420 lm
- color temperature: 2 200 K
- power: 4.5 W
- luminous efficacy: 93 lm/W
- energy efficiency class: F
- beam angle: 320°
- color rendering index (CRI): Ra >80

- voltage: 230 V~/50 Hz
- dimensions: 60 × 60 × 108 mm
- packaging: 1 pc, small box



**Z55032** 1/-/10/20  
15 25 743 227 Z55032

- replacement of incandescent bulb: 20 W
- shape: Candle
- luminous flux: 225 lm
- color temperature: 2 200 K
- power: 2.5 W
- luminous efficacy: 90 lm/W
- energy efficiency class: F
- beam angle: 320°
- color rendering index (CRI): Ra >80

- voltage: 230 V~/50 Hz
- dimensions: 35 × 35 × 97 mm
- packaging: 1 pc, small box



**Z53012** 1/-/10/40  
15 25 743 228 Z53012

- replacement of incandescent bulb: 40 W
- shape: ST64
- luminous flux: 420 lm
- color temperature: 2 200 K
- power: 4.5 W
- luminous efficacy: 93 lm/W
- energy efficiency class: F
- beam angle: 320°
- color rendering index (CRI): Ra >80

- voltage: 230 V~/50 Hz
- dimensions: 64 × 64 × 140 mm
- packaging: 1 pc, small box



**Z57032** 1/-/10/20  
15 25 743 224 Z57032

- replacement of incandescent bulb: 40 W
- shape: G95
- luminous flux: 420 lm
- color temperature: 2 200 K
- power: 4.5 W
- luminous efficacy: 93 lm/W
- energy efficiency class: F
- beam angle: 320°
- color rendering index (CRI): Ra >80

- voltage: 230 V~/50 Hz
- dimensions: 95 × 95 × 140 mm
- packaging: 1 pc, small box



**Z52032** 1/-/-/6  
15 25 743 226 Z52032

- replacement of incandescent bulb: 40 W
- shape: G125
- luminous flux: 420 lm
- color temperature: 2 200 K
- power: 4.5 W
- luminous efficacy: 93 lm/W
- energy efficiency class: F
- beam angle: 320°
- color rendering index (CRI): Ra >80

- voltage: 230 V~/50 Hz
- dimensions: 125 × 125 × 178 mm
- packaging: 1 pc, small box



**Z58032** 1/-/-/6  
15 25 743 225 Z58032

## Classic

- economical light source with an optimal price/quality ratio
- powerful, economical and extremely long lifetime
- 90% energy savings compared to conventional bulbs
- positive effect on human vision and health
- greater concentration of work and lower error rate
- 3 years warranty
- use: modern interiors, commercial and relaxation areas

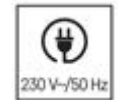

- replacement of incandescent bulb: 40 W
- shape: A60
- luminous flux: 470 lm
- color temperature: 2 700 K
- power: 4 W
- luminous efficacy: 118 lm/W
- energy efficiency class: E
- beam angle: 180°
- color rendering index (CRI): Ra >80

- voltage: 230 V~/50 Hz
- dimensions: 60 × 60 × 107 mm
- packaging: 1 pc, small box



**ZQ5E21** 1/-/10/20  
15 25 733 277 ZQ5E21

- replacement of incandescent bulb: 40 W
- shape: A60
- luminous flux: 470 lm
- color temperature: 4 000 K
- power: 4 W
- luminous efficacy: 118 lm/W
- energy efficiency class: E
- beam angle: 180°
- color rendering index (CRI): Ra >80

- voltage: 230 V~/50 Hz
- dimensions: 60 × 60 × 107 mm
- packaging: 1 pc, small box



**ZQ5E23** 1/-/10/20  
15 25 733 470 ZQ5E23

- replacement of incandescent bulb: 50 W
- shape: A60
- luminous flux: 645 lm
- color temperature: 2 700 K
- power: 5.8 W
- luminous efficacy: 111 lm/W
- energy efficiency class: E
- beam angle: 180°
- color rendering index (CRI): Ra >80

- voltage: 230 V~/50 Hz
- dimensions: 60 × 60 × 107 mm
- packaging: 1 pc, small box



**ZQ5E31** 1/-/10/20  
15 25 733 278 ZQ5E31

- replacement of incandescent bulb: 50 W
- shape: A60
- luminous flux: 645 lm
- color temperature: 4 000 K
- power: 5.8 W
- luminous efficacy: 111 lm/W
- energy efficiency class: E
- beam angle: 180°
- color rendering index (CRI): Ra >80

- voltage: 230 V~/50 Hz
- dimensions: 60 × 60 × 107 mm
- packaging: 1 pc, small box



**ZQ5E33** 1/-/10/20  
15 25 733 471 ZQ5E33

- replacement of incandescent bulb: 60 W
- shape: A60
- luminous flux: 806 lm
- color temperature: 2 700 K
- power: 7 W
- luminous efficacy: 115 lm/W
- energy efficiency class: E
- beam angle: 180°
- color rendering index (CRI): Ra >80

- voltage: 230 V~/50 Hz
- dimensions: 60 × 60 × 107 mm
- packaging: 1 pc, small box



**ZQ5E41** 1/-/10/20  
15 25 733 279 ZQ5E41

- replacement of incandescent bulb: 60 W
- shape: A60
- luminous flux: 806 lm
- color temperature: 2 700 K
- power: 7 W
- luminous efficacy: 115 lm/W
- energy efficiency class: E
- beam angle: 180°
- color rendering index (CRI): Ra >80

- voltage: 230 V~/50 Hz
- dimensions: 60 × 60 × 107 mm
- packaging: 3 pcs, small box



**ZQ5E41.3** 3/-/15/30  
15 25 733 282 ZQ5E41.3

- replacement of incandescent bulb: 60 W
- shape: A60
- luminous flux: 806 lm
- color temperature: 4 000 K
- power: 7 W
- luminous efficacy: 115 lm/W
- energy efficiency class: E
- beam angle: 180°
- color rendering index (CRI): Ra >80

- voltage: 230 V~/50 Hz
- dimensions: 60 × 60 × 107 mm
- packaging: 1 pc, small box



**ZQ5E43** 1/-/10/20  
15 25 733 472 ZQ5E43

- replacement of incandescent bulb: 60 W
- shape: A60
- luminous flux: 806 lm
- color temperature: 4 000 K
- power: 7 W
- luminous efficacy: 115 lm/W
- energy efficiency class: E
- beam angle: 180°
- color rendering index (CRI): Ra >80

- voltage: 230 V~/50 Hz
- dimensions: 60 × 60 × 107 mm
- packaging: 3 pcs, small box



**ZQ5E43.3** 3/-/15/30  
15 25 733 475 ZQ5E43.3

- replacement of incandescent bulb: 60 W
- shape: A60
- luminous flux: 806 lm
- color temperature: 6 500 K
- power: 7 W
- luminous efficacy: 115 lm/W
- energy efficiency class: E
- beam angle: 180°
- color rendering index (CRI): Ra >80

- voltage: 230 V~/50 Hz
- dimensions: 60 × 60 × 107 mm
- packaging: 1 pc, small box



**ZQ5E44** 1/-/10/20  
15 25 733 121 ZQ5E44

- replacement of incandescent bulb: 75 W
- shape: A60
- luminous flux: 1 055 lm
- color temperature: 2 700 K
- power: 9.5 W
- luminous efficacy: 111 lm/W
- energy efficiency class: E
- beam angle: 180°
- color rendering index (CRI): Ra >80

- voltage: 230 V~/50 Hz
- dimensions: 60 × 60 × 109 mm
- packaging: 1 pc, small box



**ZQ5E51** 1/-/10/20  
15 25 733 280 ZQ5E51

- replacement of incandescent bulb: 75 W
- shape: A60
- luminous flux: 1 055 lm
- color temperature: 2 700 K
- power: 9.5 W
- luminous efficacy: 111 lm/W
- energy efficiency class: E
- beam angle: 180°
- color rendering index (CRI): Ra >80

- voltage: 230 V~/50 Hz
- dimensions: 60 × 60 × 109 mm
- packaging: 3 pcs, small box



**ZQ5E51.3** 3/-/15/30  
15 25 733 284 ZQ5E51.3

- replacement of incandescent bulb: 75 W
- shape: A60
- luminous flux: 1 055 lm
- color temperature: 4 000 K
- power: 9.5 W
- luminous efficacy: 111 lm/W
- energy efficiency class: E
- beam angle: 180°
- color rendering index (CRI): Ra >80

- voltage: 230 V~/50 Hz
- dimensions: 60 × 60 × 109 mm
- packaging: 1 pc, small box



**ZQ5E53** 1/-/10/20  
15 25 733 473 ZQ5E53





www.emos.eu

Order Code  
Item Number

Packaging  
Type

- = replacement of incandescent bulb: 75 W
- = shape: A60
- = luminous flux: 1 055 lm
- = color temperature: 4 000 K
- = power: 9.5 W
- = luminous efficacy: 111 lm/W
- = energy efficiency class: E
- = beam angle: 180°
- = color rendering index (CRI): Ra >80

- = voltage: 230 V~/50 Hz
- = dimensions: 60 × 60 × 109 mm
- = packaging: 3 pcs, small box



**ZQ5E53.3** 3/-/15/30  
15 25 733 477 ZQ5E53.3

- = replacement of incandescent bulb: 75 W
- = shape: A60
- = luminous flux: 1 055 lm
- = color temperature: 6 500 K
- = power: 9.5 W
- = luminous efficacy: 111 lm/W
- = energy efficiency class: E
- = beam angle: 180°
- = color rendering index (CRI): Ra >80

- = voltage: 230 V~/50 Hz
- = dimensions: 60 × 60 × 109 mm
- = packaging: 1 pc, small box



**ZQ5E54** 1/-/10/20  
15 25 733 122 ZQ5E54

- = replacement of incandescent bulb: 75 W
- = dimmable
- = shape: A60
- = luminous flux: 1 060 lm
- = color temperature: 2 700 K
- = power: 10.5 W
- = luminous efficacy: 101 lm/W
- = energy efficiency class: F
- = beam angle: 160°

- = color rendering index (CRI): Ra >80
- = voltage: 230 V~/50 Hz
- = dimensions: 120 × 60 × 60 mm
- = packaging: 1 pc, small box



**ZL4206** 1/-/10/40  
15 25 653 206 ZL4206

- = replacement of incandescent bulb: 100 W
- = shape: A60
- = luminous flux: 1 521 lm
- = color temperature: 2 700 K
- = power: 13 W
- = luminous efficacy: 117 lm/W
- = energy efficiency class: E
- = beam angle: 180°
- = color rendering index (CRI): Ra >80

- = voltage: 230 V~/50 Hz
- = dimensions: 60 × 60 × 120 mm
- = packaging: 1 pc, small box



**ZQ5E61** 1/-/10/20  
15 25 733 281 ZQ5E61

- = replacement of incandescent bulb: 100 W
- = shape: A60
- = luminous flux: 1 521 lm
- = color temperature: 2 700 K
- = power: 13 W
- = luminous efficacy: 117 lm/W
- = energy efficiency class: E
- = beam angle: 180°
- = color rendering index (CRI): Ra >80

- = voltage: 230 V~/50 Hz
- = dimensions: 60 × 60 × 120 mm
- = packaging: 3 pcs, small box



**ZQ5E61.3** 3/-/15/30  
15 25 733 285 ZQ5E61.3

- replacement of incandescent bulb: 100 W
- shape: A60
- luminous flux: 1 521 lm
- color temperature: 4 000 K
- power: 13 W
- luminous efficacy: 117 lm/W
- energy efficiency class: E
- beam angle: 180°
- color rendering index (CRI): Ra >80

- voltage: 230 V~/50 Hz
- dimensions: 60 × 60 × 120 mm
- packaging: 1 pc, small box



**ZQ5E63** 1/-/10/20  
15 25 733 474 ZQ5E63

- replacement of incandescent bulb: 100 W
- shape: A60
- luminous flux: 1 521 lm
- color temperature: 4 000 K
- power: 13 W
- luminous efficacy: 117 lm/W
- energy efficiency class: E
- beam angle: 180°
- color rendering index (CRI): Ra >80

- voltage: 230 V~/50 Hz
- dimensions: 60 × 60 × 120 mm
- packaging: 3 pcs, small box



**ZQ5E63.3** 3/-/15/30  
15 25 733 478 ZQ5E63.3

- replacement of incandescent bulb: 100 W
- shape: A60
- luminous flux: 1 521 lm
- color temperature: 6 500 K
- power: 13 W
- luminous efficacy: 117 lm/W
- energy efficiency class: E
- beam angle: 180°
- color rendering index (CRI): Ra >80

- voltage: 230 V~/50 Hz
- dimensions: 60 × 60 × 120 mm
- packaging: 1 pc, small box



**ZQ5E64** 1/-/10/20  
15 25 733 123 ZQ5E64

- replacement of incandescent bulb: 120 W
- shape: A70
- luminous flux: 1 901 lm
- color temperature: 2 700 K
- power: 16 W
- luminous efficacy: 119 lm/W
- energy efficiency class: E
- beam angle: 180°
- color rendering index (CRI): Ra >80

- voltage: 230 V~/50 Hz
- dimensions: 71 × 71 × 142 mm
- packaging: 1 pc, small box



**ZQ5E71** 1/-/10/20  
15 25 733 286 ZQ5E71

- replacement of incandescent bulb: 120 W
- shape: A70
- luminous flux: 1 901 lm
- color temperature: 4 000 K
- power: 16 W
- luminous efficacy: 119 lm/W
- energy efficiency class: E
- beam angle: 180°
- color rendering index (CRI): Ra >80

- voltage: 230 V~/50 Hz
- dimensions: 71 × 71 × 142 mm
- packaging: 1 pc, small box



**ZQ5E73** 1/-/10/20  
15 25 733 479 ZQ5E73

- replacement of incandescent bulb: 120 W
- shape: A70
- luminous flux: 1 901 lm
- color temperature: 6 500 K
- power: 16 W
- luminous efficacy: 119 lm/W
- energy efficiency class: E
- beam angle: 180°
- color rendering index (CRI): Ra >80

- voltage: 230 V~/50 Hz
- dimensions: 71 × 71 × 142 mm
- packaging: 1 pc, small box



**ZQ5E74** 1/-/10/20  
15 25 733 124 ZQ5E74

- replacement of incandescent bulb: 150 W
- shape: A80
- luminous flux: 2 452 lm
- color temperature: 2 700 K
- power: 20 W
- luminous efficacy: 123 lm/W
- energy efficiency class: E
- beam angle: 180°
- color rendering index (CRI): Ra >80

- voltage: 230 V~/50 Hz
- dimensions: 80 × 80 × 156 mm
- packaging: 1 pc, small box



**ZQ5E81** 1/-/10/20  
15 25 733 287 ZQ5E81

- replacement of incandescent bulb: 150 W
- shape: A80
- luminous flux: 2 452 lm
- color temperature: 4 000 K
- power: 20 W
- luminous efficacy: 123 lm/W
- energy efficiency class: E
- beam angle: 180°
- color rendering index (CRI): Ra >80

- voltage: 230 V~/50 Hz
- dimensions: 80 × 80 × 156 mm
- packaging: 1 pc, small box



**ZQ5E83** 1/-/10/20  
15 25 733 480 ZQ5E83

- replacement of incandescent bulb: 150 W
- shape: A80
- luminous flux: 2 452 lm
- color temperature: 6 500 K
- power: 20 W
- luminous efficacy: 123 lm/W
- energy efficiency class: E
- beam angle: 180°
- color rendering index (CRI): Ra >80

- voltage: 230 V~/50 Hz
- dimensions: 80 × 80 × 156 mm
- packaging: 1 pc, small box



**ZQ5E84** 1/-/10/20  
15 25 733 125 ZQ5E84

- replacement of incandescent bulb: 200 W
- shape: A95
- luminous flux: 3 452 lm
- color temperature: 2 700 K
- power: 28 W
- luminous efficacy: 123 lm/W
- energy efficiency class: E
- beam angle: 180°
- color rendering index (CRI): Ra >80

- voltage: 230 V~/50 Hz
- dimensions: 95 × 95 × 178 mm
- packaging: 1 pc, small box



**ZQ5E91** 1/-/3/9  
15 25 743 215 ZQ5E91

- replacement of incandescent bulb: 200 W
- shape: A95
- luminous flux: 3 452 lm
- color temperature: 4 000 K
- power: 28 W
- luminous efficacy: 123 lm/W
- energy efficiency class: E
- beam angle: 180°
- color rendering index (CRI): Ra >80

- voltage: 230 V~/50 Hz
- dimensions: 95 × 95 × 178 mm
- packaging: 1 pc, small box



**ZQ5E93**  
15 25 743 408

1/-/3/9  
ZQ5E93

- replacement of incandescent bulb: 40 W
- shape: R50
- luminous flux: 470 lm
- color temperature: 2 700 K
- power: 4.2 W
- luminous efficacy: 112 lm/W
- energy efficiency class: E
- beam angle: 120°
- color rendering index (CRI): Ra >80

- voltage: 230 V~/50 Hz
- dimensions: 50 × 50 × 83 mm
- packaging: 1 pc, small box



**ZQ7E21**  
15 25 731 243

1/-/10/30  
ZQ7E21

- replacement of incandescent bulb: 40 W
- shape: R50
- luminous flux: 470 lm
- color temperature: 4 000 K
- power: 4.2 W
- luminous efficacy: 112 lm/W
- energy efficiency class: E
- beam angle: 120°
- color rendering index (CRI): Ra >80

- voltage: 230 V~/50 Hz
- dimensions: 50 × 50 × 83 mm
- packaging: 1 pc, small box



**ZQ7E23**  
15 25 731 442

1/-/10/30  
ZQ7E23

- replacement of incandescent bulb: 60 W
- shape: R63
- luminous flux: 806 lm
- color temperature: 2 700 K
- power: 7 W
- luminous efficacy: 115 lm/W
- energy efficiency class: E
- beam angle: 120°
- color rendering index (CRI): Ra >80

- voltage: 230 V~/50 Hz
- dimensions: 63 × 63 × 97 mm
- packaging: 1 pc, small box



**ZQ7E41**  
15 25 733 294

1/-/10/20  
ZQ7E41

- replacement of incandescent bulb: 60 W
- shape: R63
- luminous flux: 806 lm
- color temperature: 4 000 K
- power: 7 W
- luminous efficacy: 115 lm/W
- energy efficiency class: E
- beam angle: 120°
- color rendering index (CRI): Ra >80

- voltage: 230 V~/50 Hz
- dimensions: 63 × 63 × 97 mm
- packaging: 1 pc, small box



**ZQ7E43**  
15 25 733 487

1/-/10/20  
ZQ7E43



- replacement of incandescent bulb: 32 W
- shape: Mini Globe
- luminous flux: 350 lm
- color temperature: 2 700 K
- power: 2.5 W
- luminous efficacy: 140 lm/W
- energy efficiency class: D
- beam angle: 150°
- color rendering index (CRI): Ra >80

- voltage: 230 V~/50 Hz
- dimensions: 45 × 45 × 77 mm
- packaging: 1 pc, small box



**ZQ6D11** 1/-/10/40  
15 25 733 272 ZQ6D11

- replacement of incandescent bulb: 32 W
- shape: Mini Globe
- luminous flux: 350 lm
- color temperature: 4 000 K
- power: 2.5 W
- luminous efficacy: 140 lm/W
- energy efficiency class: D
- beam angle: 150°
- color rendering index (CRI): Ra >80

- voltage: 230 V~/50 Hz
- dimensions: 45 × 45 × 77 mm
- packaging: 1 pc, small box



**ZQ6D13** 1/-/10/40  
15 25 733 465 ZQ6D13

- replacement of incandescent bulb: 40 W
- shape: Mini Globe
- luminous flux: 470 lm
- color temperature: 2 700 K
- power: 4.2 W
- luminous efficacy: 112 lm/W
- energy efficiency class: E
- beam angle: 150°
- color rendering index (CRI): Ra >80

- voltage: 230 V~/50 Hz
- dimensions: 45 × 45 × 77 mm
- packaging: 1 pc, small box



**ZQ6E21** 1/-/10/40  
15 25 733 291 ZQ6E21

- replacement of incandescent bulb: 40 W
- shape: Mini Globe
- luminous flux: 470 lm
- color temperature: 2 700 K
- power: 4.2 W
- luminous efficacy: 112 lm/W
- energy efficiency class: E
- beam angle: 150°
- color rendering index (CRI): Ra >80

- voltage: 230 V~/50 Hz
- dimensions: 45 × 45 × 77 mm
- packaging: 3 pcs, small box



**ZQ6E21.3** 3/-/15/60  
15 25 733 292 ZQ6E21.3

- replacement of incandescent bulb: 40 W
- shape: Mini Globe
- luminous flux: 470 lm
- color temperature: 4 000 K
- power: 4.2 W
- luminous efficacy: 112 lm/W
- energy efficiency class: E
- beam angle: 150°
- color rendering index (CRI): Ra >80

- voltage: 230 V~/50 Hz
- dimensions: 45 × 45 × 77 mm
- packaging: 1 pc, small box



**ZQ6E23** 1/-/10/40  
15 25 733 484 ZQ6E23

- replacement of incandescent bulb: 40 W
- shape: Mini Globe
- luminous flux: 470 lm
- color temperature: 4 000 K
- power: 4.2 W
- luminous efficacy: 112 lm/W
- energy efficiency class: E
- beam angle: 150°
- color rendering index (CRI): Ra >80

- voltage: 230 V~/50 Hz
- dimensions: 45 × 45 × 77 mm
- packaging: 3 pcs, small box



**ZQ6E23.3** 3/-/15/60  
15 25 733 485 ZQ6E23.3

- replacement of incandescent bulb: 40 W
- shape: Mini Globe
- luminous flux: 470 lm
- color temperature: 6 500 K
- power: 4.2 W
- luminous efficacy: 112 lm/W
- energy efficiency class: E
- beam angle: 150°
- color rendering index (CRI): Ra >80

- voltage: 230 V~/50 Hz
- dimensions: 45 × 45 × 77 mm
- packaging: 1 pc, small box



**ZQ6E24** 1/-/10/40  
15 25 733 126 ZQ6E24

- replacement of incandescent bulb: 60 W
- shape: Mini Globe
- luminous flux: 806 lm
- color temperature: 2 700 K
- power: 6.5 W
- luminous efficacy: 124 lm/W
- energy efficiency class: E
- beam angle: 150°
- color rendering index (CRI): Ra >80

- voltage: 230 V~/50 Hz
- dimensions: 45 × 45 × 77 mm
- packaging: 1 pc, small box



**ZQ6E41** 1/-/10/40  
15 25 733 293 ZQ6E41

- replacement of incandescent bulb: 60 W
- shape: Mini Globe
- luminous flux: 806 lm
- color temperature: 4 000 K
- power: 6.5 W
- luminous efficacy: 124 lm/W
- energy efficiency class: E
- beam angle: 150°
- color rendering index (CRI): Ra >80

- voltage: 230 V~/50 Hz
- dimensions: 45 × 45 × 77 mm
- packaging: 1 pc, small box



**ZQ6E43** 1/-/10/40  
15 25 733 486 ZQ6E43

- replacement of incandescent bulb: 60 W
- shape: Mini Globe
- luminous flux: 806 lm
- color temperature: 6 500 K
- power: 6.5 W
- luminous efficacy: 124 lm/W
- energy efficiency class: E
- beam angle: 150°
- color rendering index (CRI): Ra >80

- voltage: 230 V~/50 Hz
- dimensions: 45 × 45 × 77 mm
- packaging: 1 pc, small box



**ZQ6E44** 1/-/10/40  
15 25 733 127 ZQ6E44

- replacement of incandescent bulb: 32 W
- shape: Mini Globe
- luminous flux: 350 lm
- color temperature: 2 700 K
- power: 2.5 W
- luminous efficacy: 140 lm/W
- energy efficiency class: D
- beam angle: 150°
- color rendering index (CRI): Ra >80

- voltage: 230 V~/50 Hz
- dimensions: 45 × 45 × 82 mm
- packaging: 1 pc, small box



**ZQ1D11** 1/-/10/40  
15 25 731 230 ZQ1D11

- replacement of incandescent bulb: 32 W
- shape: Mini Globe
- luminous flux: 350 lm
- color temperature: 4 000 K
- power: 2.5 W
- luminous efficacy: 140 lm/W
- energy efficiency class: D
- beam angle: 150°
- color rendering index (CRI): Ra >80

- voltage: 230 V~/50 Hz
- dimensions: 45 × 45 × 82 mm
- packaging: 1 pc, small box



**ZQ1D13** 1/-/10/40  
15 25 731 429 ZQ1D13

- replacement of incandescent bulb: 40 W
- shape: Mini Globe
- luminous flux: 470 lm
- color temperature: 2 700 K
- power: 4.2 W
- luminous efficacy: 112 lm/W
- energy efficiency class: E
- beam angle: 150°
- color rendering index (CRI): Ra >80

- voltage: 230 V~/50 Hz
- dimensions: 45 × 45 × 82 mm
- packaging: 1 pc, small box



**ZQ1E21** 1/-/10/40  
15 25 731 240 ZQ1E21

- replacement of incandescent bulb: 40 W
- shape: Mini Globe
- luminous flux: 470 lm
- color temperature: 2 700 K
- power: 4.2 W
- luminous efficacy: 112 lm/W
- energy efficiency class: E
- beam angle: 150°
- color rendering index (CRI): Ra >80

- voltage: 230 V~/50 Hz
- dimensions: 45 × 45 × 82 mm
- packaging: 3 pcs, small box



**ZQ1E21.3** 3/-/15/60  
15 25 731 241 ZQ1E21.3

- replacement of incandescent bulb: 40 W
- shape: Mini Globe
- luminous flux: 470 lm
- color temperature: 4 000 K
- power: 4.2 W
- luminous efficacy: 112 lm/W
- energy efficiency class: E
- beam angle: 150°
- color rendering index (CRI): Ra >80

- voltage: 230 V~/50 Hz
- dimensions: 45 × 45 × 82 mm
- packaging: 1 pc, small box



**ZQ1E23** 1/-/10/40  
15 25 731 439 ZQ1E23

- replacement of incandescent bulb: 40 W
- shape: Mini Globe
- luminous flux: 470 lm
- color temperature: 4 000 K
- power: 4.2 W
- luminous efficacy: 112 lm/W
- energy efficiency class: E
- beam angle: 150°
- color rendering index (CRI): Ra >80

- voltage: 230 V~/50 Hz
- dimensions: 45 × 45 × 82 mm
- packaging: 3 pcs, small box



**ZQ1E23.3** 3/-/15/60  
15 25 731 440 ZQ1E23.3

- replacement of incandescent bulb: 40 W
- shape: Mini Globe
- luminous flux: 470 lm
- color temperature: 6 500 K
- power: 4.2 W
- luminous efficacy: 112 lm/W
- energy efficiency class: E
- beam angle: 150°
- color rendering index (CRI): Ra >80

- voltage: 230 V~/50 Hz
- dimensions: 45 × 45 × 82 mm
- packaging: 1 pc, small box



**ZQ1E24** 1/-/10/40  
15 25 731 112 ZQ1E24

- replacement of incandescent bulb: 60 W
- shape: Mini Globe
- luminous flux: 806 lm
- color temperature: 2 700 K
- power: 6.5 W
- luminous efficacy: 124 lm/W
- energy efficiency class: E
- beam angle: 150°
- color rendering index (CRI): Ra >80

- voltage: 230 V~/50 Hz
- dimensions: 45 × 45 × 82 mm
- packaging: 1 pc, small box



**ZQ1E41** 1/-/10/40  
15 25 731 242 ZQ1E41

- replacement of incandescent bulb: 60 W
- shape: Mini Globe
- luminous flux: 806 lm
- color temperature: 4 000 K
- power: 6.5 W
- luminous efficacy: 124 lm/W
- energy efficiency class: E
- beam angle: 150°
- color rendering index (CRI): Ra >80

- voltage: 230 V~/50 Hz
- dimensions: 45 × 45 × 82 mm
- packaging: 1 pc, small box



**ZQ1E43** 1/-/10/40  
15 25 731 441 ZQ1E43

- replacement of incandescent bulb: 60 W
- shape: Mini Globe
- luminous flux: 806 lm
- color temperature: 6 500 K
- power: 6.5 W
- luminous efficacy: 124 lm/W
- energy efficiency class: E
- beam angle: 150°
- color rendering index (CRI): Ra >80

- voltage: 230 V~/50 Hz
- dimensions: 45 × 45 × 82 mm
- packaging: 1 pc, small box



**ZQ1E44** 1/-/10/40  
15 25 731 113 ZQ1E44



- replacement of incandescent bulb: 32 W
- shape: Candle
- luminous flux: 350 lm
- color temperature: 2 700 K
- power: 2.5 W
- luminous efficacy: 140 lm/W
- energy efficiency class: D
- beam angle: 240°
- color rendering index (CRI): Ra >80

- voltage: 230 V~/50 Hz
- dimensions: 35 × 35 × 105 mm
- packaging: 1 pc, small box



**ZQ4D11** 1/-/10/40  
15 25 733 270 ZQ4D11

- replacement of incandescent bulb: 32 W
- shape: Candle
- luminous flux: 350 lm
- color temperature: 4 000 K
- power: 2.5 W
- luminous efficacy: 140 lm/W
- energy efficiency class: D
- beam angle: 240°
- color rendering index (CRI): Ra >80

- voltage: 230 V~/50 Hz
- dimensions: 35 × 35 × 105 mm
- packaging: 1 pc, small box



**ZQ4D13** 1/-/10/40  
15 25 733 463 ZQ4D13

- replacement of incandescent bulb: 40 W
- shape: Candle
- luminous flux: 470 lm
- color temperature: 2 700 K
- power: 4.2 W
- luminous efficacy: 112 lm/W
- energy efficiency class: E
- beam angle: 240°
- color rendering index (CRI): Ra >80

- voltage: 230 V~/50 Hz
- dimensions: 35 × 35 × 105 mm
- packaging: 1 pc, small box



**ZQ4E21** 1/-/10/40  
15 25 733 289 ZQ4E21

- replacement of incandescent bulb: 40 W
- shape: Candle
- luminous flux: 470 lm
- color temperature: 4 000 K
- power: 4.2 W
- luminous efficacy: 112 lm/W
- energy efficiency class: E
- beam angle: 240°
- color rendering index (CRI): Ra >80

- voltage: 230 V~/50 Hz
- dimensions: 35 × 35 × 105 mm
- packaging: 1 pc, small box



**ZQ4E23** 1/-/10/40  
15 25 733 482 ZQ4E23

- replacement of incandescent bulb: 32 W
- shape: Candle
- luminous flux: 350 lm
- color temperature: 2 700 K
- power: 2.5 W
- luminous efficacy: 140 lm/W
- energy efficiency class: D
- beam angle: 240°
- color rendering index (CRI): Ra >80

- voltage: 230 V~/50 Hz
- dimensions: 35 × 35 × 103 mm
- packaging: 1 pc, small box



**ZQ3D11** 1/-/10/40  
15 25 731 226 ZQ3D11



www.emos.eu

Order Code  
Item Number

Packaging  
Type

- replacement of incandescent bulb: 32 W
- shape: Candle
- luminous flux: 350 lm
- color temperature: 4 000 K
- power: 2.5 W
- luminous efficacy: 140 lm/W
- energy efficiency class: D
- beam angle: 240°
- color rendering index (CRI): Ra >80

- voltage: 230 V~/50 Hz
- dimensions: 35 × 35 × 103 mm
- packaging: 1 pc, small box



**ZQ3D13** 1/-/10/40  
15 25 731 425 ZQ3D13

- replacement of incandescent bulb: 40 W
- shape: Candle
- luminous flux: 470 lm
- color temperature: 2 700 K
- power: 4.2 W
- luminous efficacy: 112 lm/W
- energy efficiency class: E
- beam angle: 240°
- color rendering index (CRI): Ra >80

- voltage: 230 V~/50 Hz
- dimensions: 35 × 35 × 103 mm
- packaging: 1 pc, small box



**ZQ3E21** 1/-/10/40  
15 25 731 236 ZQ3E21

- replacement of incandescent bulb: 40 W
- shape: Candle
- luminous flux: 470 lm
- color temperature: 2 700 K
- power: 4.2 W
- luminous efficacy: 112 lm/W
- energy efficiency class: E
- beam angle: 240°
- color rendering index (CRI): Ra >80

- voltage: 230 V~/50 Hz
- dimensions: 35 × 35 × 103 mm
- packaging: 3 pcs, small box



**ZQ3E21.3** 3/-/15/90  
15 25 731 237 ZQ3E21.3

- replacement of incandescent bulb: 40 W
- shape: Candle
- luminous flux: 470 lm
- color temperature: 4 000 K
- power: 4.2 W
- luminous efficacy: 112 lm/W
- energy efficiency class: E
- beam angle: 240°
- color rendering index (CRI): Ra >80

- voltage: 230 V~/50 Hz
- dimensions: 35 × 35 × 103 mm
- packaging: 1 pc, small box



**ZQ3E23** 1/-/10/40  
15 25 731 435 ZQ3E23

- replacement of incandescent bulb: 40 W
- shape: Candle
- luminous flux: 470 lm
- color temperature: 4 000 K
- power: 4.2 W
- luminous efficacy: 112 lm/W
- energy efficiency class: E
- beam angle: 240°
- color rendering index (CRI): Ra >80

- voltage: 230 V~/50 Hz
- dimensions: 35 × 35 × 103 mm
- packaging: 3 pcs, small box



**ZQ3E23.3** 3/-/15/90  
15 25 731 436 ZQ3E23.3



www.emos.eu

Order Code  
Item Number

Packaging  
Type

- replacement of incandescent bulb: 40 W
- shape: Candle
- luminous flux: 470 lm
- color temperature: 6 500 K
- power: 4.2 W
- luminous efficacy: 112 lm/W
- energy efficiency class: E
- beam angle: 240°
- color rendering index (CRI): Ra >80

- voltage: 230 V~/50 Hz
- dimensions: 35 × 35 × 103 mm
- packaging: 1 pc, small box



**ZQ3E24** 1/-/10/40  
15 25 731 110 ZQ3E24

- replacement of incandescent bulb: 60 W
- shape: Candle
- luminous flux: 806 lm
- color temperature: 2 700 K
- power: 6.5 W
- luminous efficacy: 124 lm/W
- energy efficiency class: E
- beam angle: 240°
- color rendering index (CRI): Ra >80

- voltage: 230 V~/50 Hz
- dimensions: 35 × 35 × 103 mm
- packaging: 1 pc, small box



**ZQ3E41** 1/-/10/40  
15 25 731 238 ZQ3E41

- replacement of incandescent bulb: 60 W
- shape: Candle
- luminous flux: 806 lm
- color temperature: 4 000 K
- power: 6.5 W
- luminous efficacy: 124 lm/W
- energy efficiency class: E
- beam angle: 240°
- color rendering index (CRI): Ra >80

- voltage: 230 V~/50 Hz
- dimensions: 35 × 35 × 103 mm
- packaging: 1 pc, small box



**ZQ3E43** 1/-/10/40  
15 25 731 437 ZQ3E43

- replacement of incandescent bulb: 60 W
- shape: Candle
- luminous flux: 806 lm
- color temperature: 6 500 K
- power: 6.5 W
- luminous efficacy: 124 lm/W
- energy efficiency class: E
- beam angle: 240°
- color rendering index (CRI): Ra >80

- voltage: 230 V~/50 Hz
- dimensions: 35 × 35 × 103 mm
- packaging: 1 pc, small box



**ZQ3E44** 1/-/10/40  
15 25 731 111 ZQ3E44

- replacement of incandescent bulb: 32 W
- shape: MR16
- luminous flux: 345 lm
- color temperature: 3 000 K
- power: 3 W
- luminous efficacy: 115 lm/W
- energy efficiency class: E
- beam angle: 100°
- color rendering index (CRI): Ra >80

- voltage: 230 V~/50 Hz
- dimensions: 50 × 50 × 58 mm
- packaging: 1 pc, small box



**ZQ8E12** 1/-/10/60  
15 25 730 229 ZQ8E12

- replacement of incandescent bulb: 32 W
- shape: MR16
- luminous flux: 345 lm
- color temperature: 3 000 K
- power: 3 W
- luminous efficacy: 115 lm/W
- energy efficiency class: E
- beam angle: 100°
- color rendering index (CRI): Ra >80

- voltage: 230 V~/50 Hz
- dimensions: 50 × 50 × 55 mm
- packaging: 1 pc, small box



**ZQ8E17** 1/-/10/60  
15 25 730 232 ZQ8E17

- replacement of incandescent bulb: 32 W
- shape: MR16
- luminous flux: 345 lm
- color temperature: 3 000 K
- power: 3 W
- luminous efficacy: 115 lm/W
- energy efficiency class: E
- beam angle: 100°
- color rendering index (CRI): Ra >80

- voltage: 230 V~/50 Hz
- dimensions: 50 × 50 × 58 mm
- packaging: 3 pcs, small box



**ZQ8E12.3** 3/-/15/60  
15 25 730 233 ZQ8E12.3

- replacement of incandescent bulb: 40 W
- shape: MR16
- luminous flux: 535 lm
- color temperature: 4 000 K
- power: 3 W
- luminous efficacy: 210 lm/W
- energy efficiency class: A
- beam angle: 100°
- color rendering index (CRI): Ra >80

- voltage: 230 V~/50 Hz
- dimensions: 50 × 50 × 55 mm
- packaging: 1 pc, small box



**ZQ8338** 1/-/10/60  
15 25 730 423 ZQ8338

- replacement of incandescent bulb: 32 W
- shape: MR16
- luminous flux: 345 lm
- color temperature: 4 000 K
- power: 3 W
- luminous efficacy: 115 lm/W
- energy efficiency class: E
- beam angle: 100°
- color rendering index (CRI): Ra >80

- voltage: 230 V~/50 Hz
- dimensions: 50 × 50 × 58 mm
- packaging: 1 pc, small box



**ZQ8E13** 1/-/10/60  
15 25 730 424 ZQ8E13

- replacement of incandescent bulb: 32 W
- shape: MR16
- luminous flux: 345 lm
- color temperature: 4 000 K
- power: 3 W
- luminous efficacy: 115 lm/W
- energy efficiency class: E
- beam angle: 100°
- color rendering index (CRI): Ra >80

- voltage: 230 V~/50 Hz
- dimensions: 50 × 50 × 55 mm
- packaging: 1 pc, small box



**ZQ8E18** 1/-/10/60  
15 25 730 427 ZQ8E18



- replacement of incandescent bulb: 32 W
- shape: MR16
- luminous flux: 345 lm
- color temperature: 6 500 K
- power: 3 W
- luminous efficacy: 115 lm/W
- energy efficiency class: E
- beam angle: 100°
- color rendering index (CRI): Ra >80

- voltage: 230 V~/50 Hz
- dimensions: 50 × 50 × 58 mm
- packaging: 1 pc, small box



**ZQ8E14** 1/-/10/60  
15 25 730 114 ZQ8E14

- replacement of incandescent bulb: 32 W
- shape: MR16
- luminous flux: 345 lm
- color temperature: 6 500 K
- power: 3 W
- luminous efficacy: 115 lm/W
- energy efficiency class: E
- beam angle: 100°
- color rendering index (CRI): Ra >80

- voltage: 230 V~/50 Hz
- dimensions: 50 × 50 × 55 mm
- packaging: 1 pc, small box



**ZQ8E19** 1/-/10/60  
15 25 730 116 ZQ8E19

- replacement of incandescent bulb: 39 W
- shape: MR16
- luminous flux: 450 lm
- color temperature: 3 000 K
- power: 4 W
- luminous efficacy: 113 lm/W
- energy efficiency class: E
- beam angle: 100°
- color rendering index (CRI): Ra >80

- voltage: 230 V~/50 Hz
- dimensions: 50 × 50 × 58 mm
- packaging: 1 pc, small box



**ZQ8E22** 1/-/10/60  
15 25 730 230 ZQ8E22

- replacement of incandescent bulb: 39 W
- shape: MR16
- luminous flux: 450 lm
- color temperature: 4 000 K
- power: 4 W
- luminous efficacy: 113 lm/W
- energy efficiency class: E
- beam angle: 100°
- color rendering index (CRI): Ra >80

- voltage: 230 V~/50 Hz
- dimensions: 50 × 50 × 58 mm
- packaging: 1 pc, small box



**ZQ8E23** 1/-/10/60  
15 25 730 425 ZQ8E23

- replacement of incandescent bulb: 75 W
- shape: MR16
- luminous flux: 565 lm
- color temperature: 4 000 K
- power: 5.8 W
- luminous efficacy: 115 lm/W
- energy efficiency class: E
- beam angle: 36°
- color rendering index (CRI): Ra >80

- voltage: 230 V~/50 Hz
- dimensions: 50 × 50 × 56 mm
- packaging: 1 pc, small box



**ZQ8E33N** 1/-/10/60  
15 25 730 428 ZQ8E33N

- replacement of incandescent bulb: 60 W
- dimmable
- shape: MR16
- luminous flux: 800 lm
- color temperature: 3 000 K
- power: 7 W
- luminous efficacy: 114 lm/W
- energy efficiency class: E
- beam angle: 100°

- color rendering index (CRI): Ra >80
- voltage: 230 V~/50 Hz
- dimensions: 50 × 50 × 58 mm
- packaging: 1 pc, small box



**ZQ8155S** 1/-/10/60  
15 25 730 220 ZQ8155S

- replacement of incandescent bulb: 60 W
- dimmable
- shape: MR16
- luminous flux: 800 lm
- color temperature: 3 000 K
- power: 7 W
- luminous efficacy: 114 lm/W
- energy efficiency class: E
- beam angle: 100°

- color rendering index (CRI): Ra >80
- voltage: 230 V~/50 Hz
- dimensions: 50 × 50 × 58 mm
- packaging: 1 pc, small box



**ZQ8155D** 1/-/10/60  
15 25 730 221 ZQ8155D

- replacement of incandescent bulb: 60 W
- shape: MR16
- luminous flux: 806 lm
- color temperature: 3 000 K
- power: 7 W
- luminous efficacy: 115 lm/W
- energy efficiency class: E
- beam angle: 100°
- color rendering index (CRI): Ra >80

- voltage: 230 V~/50 Hz
- dimensions: 50 × 50 × 58 mm
- packaging: 1 pc, small box



**ZQ8E42** 1/-/10/60  
15 25 730 225 ZQ8E42

- replacement of incandescent bulb: 60 W
- shape: MR16
- luminous flux: 806 lm
- color temperature: 3 000 K
- power: 7 W
- luminous efficacy: 115 lm/W
- energy efficiency class: E
- beam angle: 100°
- color rendering index (CRI): Ra >80

- voltage: 230 V~/50 Hz
- dimensions: 50 × 50 × 58 mm
- packaging: 3 pcs, small box



**ZQ8E42.3** 3/-/15/60  
15 25 730 228 ZQ8E42.3

- replacement of incandescent bulb: 60 W
- dimmable
- shape: MR16
- luminous flux: 800 lm
- color temperature: 4 000 K
- power: 7 W
- luminous efficacy: 114 lm/W
- energy efficiency class: E
- beam angle: 100°

- color rendering index (CRI): Ra >80
- voltage: 230 V~/50 Hz
- dimensions: 50 × 50 × 58 mm
- packaging: 1 pc, small box



**ZQ8255S** 1/-/10/60  
15 25 730 415 ZQ8255S

- replacement of incandescent bulb: 60 W
- dimmable
- shape: MR16
- luminous flux: 800 lm
- color temperature: 4 000 K
- power: 7 W
- luminous efficacy: 114 lm/W
- energy efficiency class: E
- beam angle: 100°

- color rendering index (CRI): Ra >80
- voltage: 230 V~/50 Hz
- dimensions: 50 × 50 × 58 mm
- packaging: 1 pc, small box



**ZQ8255D** 1/-/10/60  
15 25 730 416 ZQ8255D

- replacement of incandescent bulb: 60 W
- shape: MR16
- luminous flux: 806 lm
- color temperature: 4 000 K
- power: 7 W
- luminous efficacy: 115 lm/W
- energy efficiency class: E
- beam angle: 100°
- color rendering index (CRI): Ra >80

- voltage: 230 V~/50 Hz
- dimensions: 50 × 50 × 58 mm
- packaging: 1 pc, small box



**ZQ8E43** 1/-/10/60  
15 25 730 419 ZQ8E43

- replacement of incandescent bulb: 60 W
- shape: MR16
- luminous flux: 806 lm
- color temperature: 4 000 K
- power: 7 W
- luminous efficacy: 115 lm/W
- energy efficiency class: E
- beam angle: 100°
- color rendering index (CRI): Ra >80

- voltage: 230 V~/50 Hz
- dimensions: 50 × 50 × 58 mm
- packaging: 3 pcs, small box



**ZQ8E43.3** 3/-/15/60  
15 25 730 422 ZQ8E43.3

- replacement of incandescent bulb: 60 W
- shape: MR16
- luminous flux: 806 lm
- color temperature: 6 500 K
- power: 7 W
- luminous efficacy: 115 lm/W
- energy efficiency class: E
- beam angle: 100°
- color rendering index (CRI): Ra >80

- voltage: 230 V~/50 Hz
- dimensions: 50 × 50 × 58 mm
- packaging: 1 pc, small box



**ZQ8E44** 1/-/10/60  
15 25 730 112 ZQ8E44

- replacement of incandescent bulb: 40 W
- dimmable
- shape: JC
- luminous flux: 470 lm
- color temperature: 3 000 K
- power: 4.2 W
- luminous efficacy: 112 lm/W
- energy efficiency class: E
- beam angle: 300°

- color rendering index (CRI): Ra >80
- voltage: 230 V~/50 Hz
- dimensions: 18 × 18 × 60 mm
- packaging: 1 pc, small box



**ZQ9125D** 1/-/10/60  
15 25 736 211 ZQ9125D



www.emos.eu

Order Code  
Item Number

Packaging  
Type

- replacement of incandescent bulb: 40 W
- dimmable
- shape: JC
- luminous flux: 470 lm
- color temperature: 4 000 K
- power: 4.2 W
- luminous efficacy: 112 lm/W
- energy efficiency class: E
- beam angle: 300°
- color rendering index (CRI): Ra >80
- voltage: 230 V~/50 Hz
- dimensions: 18 × 18 × 60 mm
- packaging: 1 pc., small box



**ZQ9225D** 1/-/10/60  
15 25 736 411 ZQ9225D

## Basic

- most popular bulb types, found in most households
- economical replacement for obsolete tungsten filament bulbs
- low price and power consumption yet high efficiency
- lights up to 100 % immediately after pressing the switch



- replacement of incandescent bulb: 60 W
- shape: A60
- luminous flux: 806 lm
- color temperature: 3 000 K
- power: 9.4 W
- luminous efficacy: 86 lm/W
- energy efficiency class: F
- beam angle: 200°
- color rendering index (CRI): Ra >80
- voltage: 230 V~/50 Hz
- dimensions: 60 × 60 × 110 (max.) mm
- packaging: 1 pc., small box



**ZL5F42** 1/-/10/30  
15 25 733 296 ZL5F42

- replacement of incandescent bulb: 60 W
- shape: A60
- luminous flux: 806 lm
- color temperature: 3 000 K
- power: 9.4 W
- luminous efficacy: 86 lm/W
- energy efficiency class: F
- beam angle: 200°
- color rendering index (CRI): Ra >80
- voltage: 230 V~/50 Hz
- dimensions: 60 × 60 × 110 (max.) mm
- packaging: 3 pcs., small box



**ZL5F42.3** 3/-/15/45  
15 25 733 299 ZL5F42.3

- replacement of incandescent bulb: 60 W
- shape: A60
- luminous flux: 806 lm
- color temperature: 3 000 K
- power: 9.4 W
- luminous efficacy: 86 lm/W
- energy efficiency class: F
- beam angle: 200°
- color rendering index (CRI): Ra >80
- voltage: 230 V~/50 Hz
- dimensions: 60 × 60 × 110 (max.) mm
- packaging: 6 pcs., small box



**ZL5F42.6** 6/-/1/48  
15 25 743 200 ZL5F42.6



- replacement of incandescent bulb: 60 W
- shape: A60
- luminous flux: 806 lm
- color temperature: 4 000 K
- power: 9.4 W
- luminous efficacy: 86 lm/W
- energy efficiency class: F
- beam angle: 200°
- color rendering index (CRI): Ra >80

- voltage: 230 V~/50 Hz
- dimensions: 60 × 60 × 110 (max.) mm
- packaging: 1 pc, small box



**ZL5F43** 1/-/10/30  
15 25 733 492 ZL5F43

- replacement of incandescent bulb: 60 W
- shape: A60
- luminous flux: 806 lm
- color temperature: 4 000 K
- power: 9.4 W
- luminous efficacy: 86 lm/W
- energy efficiency class: F
- beam angle: 200°
- color rendering index (CRI): Ra >80

- voltage: 230 V~/50 Hz
- dimensions: 60 × 60 × 110 (max.) mm
- packaging: 3 pcs, small box



**ZL5F43.3** 3/-/15/45  
15 25 733 495 ZL5F43.3

- replacement of incandescent bulb: 60 W
- shape: A60
- luminous flux: 806 lm
- color temperature: 4 000 K
- power: 9.4 W
- luminous efficacy: 86 lm/W
- energy efficiency class: F
- beam angle: 200°
- color rendering index (CRI): Ra >80

- voltage: 230 V~/50 Hz
- dimensions: 60 × 60 × 110 (max.) mm
- packaging: 6 pcs, small box



**ZL5F43.6** 6/-/-/48  
15 25 733 496 ZL5F43.6

- replacement of incandescent bulb: 75 W
- shape: A60
- luminous flux: 1 055 lm
- color temperature: 3 000 K
- power: 12.4 W
- luminous efficacy: 85 lm/W
- energy efficiency class: F
- beam angle: 200°
- color rendering index (CRI): Ra >80

- voltage: 230 V~/50 Hz
- dimensions: 60 × 60 × 110 (max.) mm
- packaging: 1 pc, small box



**ZL5F52** 1/-/10/30  
15 25 743 229 ZL5F52

- replacement of incandescent bulb: 75 W
- shape: A60
- luminous flux: 1 055 lm
- color temperature: 4 000 K
- power: 12.4 W
- luminous efficacy: 85 lm/W
- energy efficiency class: F
- beam angle: 200°
- color rendering index (CRI): Ra >80

- voltage: 230 V~/50 Hz
- dimensions: 60 × 60 × 110 (max.) mm
- packaging: 1 pc, small box



**ZL5F53** 1/-/10/30  
15 25 743 411 ZL5F53

- replacement of incandescent bulb: 100 W
- shape: A60
- luminous flux: 1 521 lm
- color temperature: 3 000 K
- power: 17.8 W
- luminous efficacy: 85 lm/W
- energy efficiency class: F
- beam angle: 200°
- color rendering index (CRI): Ra >80

- voltage: 230 V~/50 Hz
- dimensions: 60 × 60 × 125 (max.) mm
- packaging: 1 pc, small box



**ZL5F62** 1/-/10/30  
15 25 743 230 ZL5F62

- replacement of incandescent bulb: 100 W
- shape: A60
- luminous flux: 1 521 lm
- color temperature: 4 000 K
- power: 17.8 W
- luminous efficacy: 85 lm/W
- energy efficiency class: F
- beam angle: 200°
- color rendering index (CRI): Ra >80

- voltage: 230 V~/50 Hz
- dimensions: 60 × 60 × 125 (max.) mm
- packaging: 1 pc, small box



**ZL5F63** 1/-/10/30  
15 25 743 412 ZL5F63

- replacement of incandescent bulb: 40 W
- shape: Mini Globe
- luminous flux: 470 lm
- color temperature: 3 000 K
- power: 5.5 W
- luminous efficacy: 85 lm/W
- energy efficiency class: F
- beam angle: 180°
- color rendering index (CRI): Ra >80

- voltage: 230 V~/50 Hz
- dimensions: 45 × 45 × 82 (max.) mm
- packaging: 1 pc, small box



**ZL6F22** 1/-/10/60  
15 25 743 202 ZL6F22

- replacement of incandescent bulb: 40 W
- shape: Mini Globe
- luminous flux: 470 lm
- color temperature: 3 000 K
- power: 5.5 W
- luminous efficacy: 85 lm/W
- energy efficiency class: F
- beam angle: 180°
- color rendering index (CRI): Ra >80

- voltage: 230 V~/50 Hz
- dimensions: 45 × 45 × 82 (max.) mm
- packaging: 1 pc, small box



**ZL1F22** 1/-/10/60  
15 25 731 246 ZL1F22

- replacement of incandescent bulb: 60 W
- shape: Mini Globe
- luminous flux: 806 lm
- color temperature: 3 000 K
- power: 9.4 W
- luminous efficacy: 86 lm/W
- energy efficiency class: F
- beam angle: 180°
- color rendering index (CRI): Ra >80

- voltage: 230 V~/50 Hz
- dimensions: 45 × 45 × 82 (max.) mm
- packaging: 1 pc, small box



**ZL1F42** 1/-/10/60  
15 25 731 247 ZL1F42



www.emos.eu

Order Code  
Item Number

Packaging  
Type

- replacement of incandescent bulb: 60 W
- shape: Mini Globe
- luminous flux: 806 lm
- color temperature: 4 000 K
- power: 9.4 W
- luminous efficacy: 86 lm/W
- energy efficiency class: F
- beam angle: 180°
- color rendering index (CRI): Ra >80

- voltage: 230 V~/50 Hz
- dimensions: 45 × 45 × 82 (max.) mm
- packaging: 1 pc, small box



**ZL1F43**  
15 25 731 444

1/-/10/60  
ZL1F43

- replacement of incandescent bulb: 40 W
- shape: Candle
- luminous flux: 470 lm
- color temperature: 3 000 K
- power: 5.5 W
- luminous efficacy: 85 lm/W
- energy efficiency class: F
- beam angle: 180°
- color rendering index (CRI): Ra >80

- voltage: 230 V~/50 Hz
- dimensions: 35 × 35 × 105 (max.) mm
- packaging: 1 pc, small box



**ZL4F22**  
15 25 743 201

1/-/10/60  
ZL4F22

- replacement of incandescent bulb: 40 W
- shape: Candle
- luminous flux: 470 lm
- color temperature: 3 000 K
- power: 5.5 W
- luminous efficacy: 85 lm/W
- energy efficiency class: F
- beam angle: 180°
- color rendering index (CRI): Ra >80

- voltage: 230 V~/50 Hz
- dimensions: 35 × 35 × 105 (max.) mm
- packaging: 1 pc, small box



**ZL3F22**  
15 25 731 244

1/-/10/60  
ZL3F22

- replacement of incandescent bulb: 60 W
- shape: Candle
- luminous flux: 806 lm
- color temperature: 3 000 K
- power: 9.4 W
- luminous efficacy: 86 lm/W
- energy efficiency class: F
- beam angle: 180°
- color rendering index (CRI): Ra >80

- voltage: 230 V~/50 Hz
- dimensions: 35 × 35 × 110 (max.) mm
- packaging: 1 pc, small box



**ZL3F42**  
15 25 731 245

1/-/10/60  
ZL3F42

- replacement of incandescent bulb: 60 W
- shape: Candle
- luminous flux: 806 lm
- color temperature: 4 000 K
- power: 9.4 W
- luminous efficacy: 86 lm/W
- energy efficiency class: F
- beam angle: 180°
- color rendering index (CRI): Ra >80

- voltage: 230 V~/50 Hz
- dimensions: 35 × 35 × 110 (max.) mm
- packaging: 1 pc, small box



**ZL3F43**  
15 25 731 443

1/-/10/60  
ZL3F43

- replacement of incandescent bulb: 25 W
- shape: MR16
- luminous flux: 250 lm
- color temperature: 3 000 K
- power: 2.9 W
- luminous efficacy: 86 lm/W
- energy efficiency class: F
- beam angle: 110°
- color rendering index (CRI): Ra >80

- voltage: 230 V~/50 Hz
- dimensions: 50 × 50 × 58 (max.) mm
- packaging: 1 pc, small box



**ZL8F02** 1/-/10/90  
15 25 730 234 ZL8F02

- replacement of incandescent bulb: 25 W
- shape: MR16
- luminous flux: 250 lm
- color temperature: 4 000 K
- power: 2.9 W
- luminous efficacy: 86 lm/W
- energy efficiency class: F
- beam angle: 110°
- color rendering index (CRI): Ra >80

- voltage: 230 V~/50 Hz
- dimensions: 50 × 50 × 58 (max.) mm
- packaging: 1 pc, small box



**ZL8F03** 1/-/10/90  
15 25 730 429 ZL8F03

- replacement of incandescent bulb: 40 W
- shape: MR16
- luminous flux: 450 lm
- color temperature: 3 000 K
- power: 5.2 W
- luminous efficacy: 87 lm/W
- energy efficiency class: F
- beam angle: 110°
- color rendering index (CRI): Ra >80

- voltage: 230 V~/50 Hz
- dimensions: 50 × 50 × 58 (max.) mm
- packaging: 1 pc, small box



**ZL8F22** 1/-/10/90  
15 25 730 235 ZL8F22

- replacement of incandescent bulb: 40 W
- shape: MR16
- luminous flux: 450 lm
- color temperature: 4 000 K
- power: 5.2 W
- luminous efficacy: 87 lm/W
- energy efficiency class: F
- beam angle: 110°
- color rendering index (CRI): Ra >80

- voltage: 230 V~/50 Hz
- dimensions: 50 × 50 × 58 (max.) mm
- packaging: 1 pc, small box



**ZL8F23** 1/-/10/90  
15 25 730 430 ZL8F23



# GoSmart Bulbs



- Remote light on/off
- Brightness, light colour and chromaticity temperature control
- Energy saving with automatic switch-off and dimming options
- Set unique lighting scenes for different activities
- Easy to install and create automations
- Connection to the home network via WIFI protocol
- Compatibility with EMOS GoSmart products and TUYA devices
- Voice control with Google Assistant and Amazon Alexa

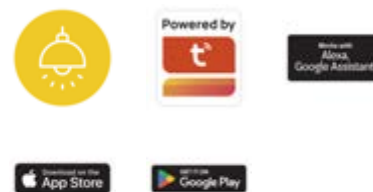

- replacement of incandescent bulb: 60 W
- dimmable
- shape: A60
- luminous flux: 806 lm
- color temperature: 2 700–6 500 K
- power: 9 W
- luminous efficacy: 90 lm/W
- energy efficiency class: F
- beam angle: 200°
- color rendering index (CRI): Ra >80
- voltage: 230 V~/50 Hz
- dimensions: 60 × 60 × 120 mm
- packaging: 1 pc, small box
- supported OS: Android, iOS
- compatibility: EMOS GoSmart, TUYA, LIDL, Smartlife
- protocol: Wi-Fi
- control by voice assistants
- notifications to the mobile app



**ZQW514R** 1/-/10/40  
15 20 503 500 ZQW514R

- replacement of incandescent bulb: 75 W
- dimmable
- shape: A60
- luminous flux: 1 050 lm
- color temperature: 2 700–6 500 K
- power: 11 W
- luminous efficacy: 95 lm/W
- energy efficiency class: F
- beam angle: 200°
- color rendering index (CRI): Ra >80
- voltage: 230 V~/50 Hz
- dimensions: 60 × 60 × 125 mm
- packaging: 1 pc, small box
- supported OS: Android, iOS
- compatibility: EMOS GoSmart, TUYA, LIDL, Smartlife
- protocol: Wi-Fi
- control by voice assistants
- notifications to the mobile app

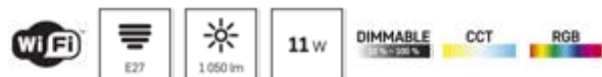

**ZQW515R** 1/-/10/40  
15 20 503 501 ZQW515R

- replacement of incandescent bulb: 94 W
- dimmable
- shape: A65
- luminous flux: 1 400 lm
- color temperature: 2 700–6 500 K
- power: 14 W
- luminous efficacy: 100 lm/W
- energy efficiency class: F
- beam angle: 200°
- color rendering index (CRI): Ra >80
- voltage: 230 V~/50 Hz
- dimensions: 65 × 65 × 134 mm
- packaging: 1 pc, small box
- supported OS: Android, iOS
- compatibility: EMOS GoSmart, TUYA, LIDL, Smartlife
- protocol: Wi-Fi
- control by voice assistants
- notifications to the mobile app



**ZQW516R** 1/-/4/24  
15 20 503 502 ZQW516R

- replacement of incandescent bulb: 40 W
- dimmable
- shape: Candle
- luminous flux: 470 lm
- color temperature: 2 700–6 500 K
- power: 4.8 W
- luminous efficacy: 98 lm/W
- energy efficiency class: F
- beam angle: 180°
- color rendering index (CRI): Ra >80
- voltage: 230 V~/50 Hz
- dimensions: 37 × 37 × 110 mm
- packaging: 1 pc, small box
- supported OS: Android, iOS
- compatibility: EMOS GoSmart, TUYA, LIDL, Smartlife
- protocol: Wi-Fi
- control by voice assistants
- notifications to the mobile app



**ZQW322R** 1/-/10/60  
15 25 501 500 ZQW322R



www.emos.eu

Order Code  
Item Number

Packaging  
Type

- replacement of incandescent bulb: 35 W
- dimmable
- shape: MR16
- luminous flux: 400 lm
- color temperature: 2 700–6 500 K
- power: 4.8 W
- luminous efficacy: 83 lm/W
- energy efficiency class: G
- beam angle: 120°

- color rendering index (CRI): Ra >80
- voltage: 230 V~/50 Hz
- dimensions: 50 × 50 × 56.5 mm
- packaging: 1 pc, small box
- supported OS: Android, iOS
- compatibility: EMOS GoSmart, TUYA, LIDL, Smartlife
- protocol: Wi-Fi
- control by voice assistants
- notifications to the mobile app



**ZQW832R** 1/-/4/72  
15 25 500 500 ZQW832R

- replacement of incandescent bulb: 60 W
- dimmable
- shape: A60
- luminous flux: 806 lm
- color temperature: 2 700–6 500 K
- power: 9 W
- luminous efficacy: 90 lm/W
- energy efficiency class: F
- beam angle: 200°

- color rendering index (CRI): Ra >80
- voltage: 230 V~/50 Hz
- dimensions: 60 × 60 × 120 mm
- packaging: 1 pc, small box
- supported OS: Android, iOS
- compatibility: EMOS GoSmart, TUYA, LIDL, Smartlife
- protocol: Zigbee 3.0
- control by voice assistants
- notifications to the mobile app



**ZQZ514R** 1/-/10/40  
15 25 753 500 ZQZ514R

- replacement of incandescent bulb: 75 W
- dimmable
- shape: A60
- luminous flux: 1 050 lm
- color temperature: 2 700–6 500 K
- power: 11 W
- luminous efficacy: 95 lm/W
- energy efficiency class: F
- beam angle: 200°

- color rendering index (CRI): Ra >80
- voltage: 230 V~/50 Hz
- dimensions: 60 × 60 × 125 mm
- packaging: 1 pc, small box
- supported OS: Android, iOS
- compatibility: EMOS GoSmart, TUYA, LIDL, Smartlife
- protocol: Zigbee 3.0
- control by voice assistants
- notifications to the mobile app



**ZQZ515R** 1/-/10/40  
15 25 753 501 ZQZ515R

- replacement of incandescent bulb: 94 W
- dimmable
- shape: A65
- luminous flux: 1 400 lm
- color temperature: 2 700–6 500 K
- power: 14 W
- luminous efficacy: 100 lm/W
- energy efficiency class: F
- beam angle: 200°

- color rendering index (CRI): Ra >80
- voltage: 230 V~/50 Hz
- dimensions: 65 × 65 × 134 mm
- packaging: 1 pc, small box
- supported OS: Android, iOS
- compatibility: EMOS GoSmart, TUYA, LIDL, Smartlife
- protocol: Zigbee 3.0
- control by voice assistants
- notifications to the mobile app



**ZQZ516R** 1/-/10/40  
15 25 753 502 ZQZ516R

- replacement of incandescent bulb: 40 W
- dimmable
- shape: Candle
- luminous flux: 470 lm
- color temperature: 2 700–6 500 K
- power: 4.8 W
- luminous efficacy: 98 lm/W
- energy efficiency class: F
- beam angle: 180°

- color rendering index (CRI): Ra >80
- voltage: 230 V~/50 Hz
- dimensions: 37 × 37 × 110 mm
- packaging: 1 pc, small box
- supported OS: Android, iOS
- compatibility: EMOS GoSmart, TUYA, LIDL, Smartlife
- protocol: Zigbee 3.0
- control by voice assistants
- notifications to the mobile app



**ZQZ322R** 1/-/10/60  
15 25 751 500 ZQZ322R



www.emos.eu

Order Code  
Item Number

Packaging  
Type

- replacement of incandescent bulb: 35 W
- dimmable
- shape: MR16
- luminous flux: 400 lm
- color temperature: 2 700-6 500 K
- power: 4.8 W
- luminous efficacy: 83 lm/W
- energy efficiency class: G
- beam angle: 120°
- color rendering index (CRI): Ra >80
- voltage: 230 V~/50 Hz
- dimensions: 50 × 50 × 56.5 mm
- packaging: 1 pc, small box
- supported OS: Android, iOS
- compatibility: EMOS GoSmart, TUYA, LIDL, Smartlife
- protocol: Zigbee 3.0
- control by voice assistants
- notifications to the mobile app



**ZQZ832R**

1/-/4/72

15 25 750 500

ZQZ832R

## Light sources

### Light bulbs for electrical appliances

- energy-saving LED and classic bulbs for kitchen appliances
- shape adapted for use in various household appliances
- with E14 lamp cap
- bulb for oven, can withstand up to 300 °C

- replacement of incandescent bulb: 17 W
- shape: ST26
- luminous flux: 160 lm
- color temperature: 4 000 K
- power: 1.8 W
- luminous efficacy: 89 lm/W
- energy efficiency class: F
- beam angle: 150°
- color rendering index (CRI): Ra >80

- voltage: 230 V~/50 Hz
- dimensions: 58 × 27 × 27 mm
- packaging: 1 pc, small box



**Z6913**

1/-/10/100

15 24 014 013

LED-FR-1,6W-NW

- replacement of incandescent bulb: 40 W
- shape: JC
- luminous flux: 465 lm
- color temperature: 3 000 K
- power: 4.5 W
- luminous efficacy: 103 lm/W
- energy efficiency class: F
- beam angle: 300°
- color rendering index (CRI): Ra >80

- voltage: 230 V~/50 Hz
- dimensions: 58 × 20 × 20 mm
- packaging: 1 pc, small box



**ZQ9140**

1/-/10/60

15 25 731 208

ZQ9140

- replacement of incandescent bulb: 40 W
- shape: JC
- luminous flux: 465 lm
- color temperature: 4 000 K
- power: 4.5 W
- luminous efficacy: 103 lm/W
- energy efficiency class: F
- beam angle: 300°
- color rendering index (CRI): Ra >80

- voltage: 230 V~/50 Hz
- dimensions: 58 × 20 × 20 mm
- packaging: 1 pc, small box



**ZQ9141** 1/-/10/60  
15 25 731 407 ZQ9141

- type: special lamp for oven
- voltage: 230 V
- power: 15 W
- color temperature: 300 °C
- socket (bulb holder): E14
- luminous flux: 58 lm
- packaging: 1 pc, box
- dimensions: 23 × 45 mm



**Z6911** 1/-/10/300  
15 24 115 010 Z2

- type: fume hood bulb
- voltage: 230 V
- power: 40 W
- socket (bulb holder): E14
- luminous flux: 400 lm
- packaging: 1 pc, box
- dimensions: 25 × 82 mm



**C5109** 1/-/-/100  
31 32 510 900 ADR 230-240V  
40W/E14

## ECO halogen

- more energy-efficient version of classic tungsten fibre bulb
- lights up to 100 % immediately after pressing the switch
- smooth dimming capability (when used with suitable dimmer)

- replacement of incandescent bulb: 94 W
- dimmable
- shape: J78
- luminous flux: 1 400 lm
- color temperature: 3 000 K
- power: 80 W
- luminous efficacy: 18 lm/W
- energy efficiency class: G
- beam angle: 360°

- color rendering index (CRI): Ra >99
- voltage: 230 V~/50 Hz
- dimensions: 8 × 78 × 8 mm
- packaging: 1 pc, small box



**ZE0101** 1/10/50/300  
15 27 000 800 ECL 80-J78



- replacement of incandescent bulb: 139 W
- dimmable
- shape: J78
- luminous flux: 2 250 lm
- color temperature: 3 000 K
- power: 120 W
- luminous efficacy: 19 lm/W
- energy efficiency class: G
- beam angle: 360°
- color rendering index (CRI): Ra >99
- voltage: 230 V~/50 Hz
- dimensions: 8 × 78 × 8 mm
- packaging: 1 pc, small box

**ZE0102**

1/10/50/500

15 27 001 200

ECL 120-J78



- replacement of incandescent bulb: 161 W
- dimmable
- shape: J118
- luminous flux: 2 680 lm
- color temperature: 3 000 K
- power: 140 W
- luminous efficacy: 19 lm/W
- energy efficiency class: G
- beam angle: 360°
- color rendering index (CRI): Ra >99
- voltage: 230 V~/50 Hz
- dimensions: 10 × 118 × 10 mm
- packaging: 1 pc, small box

**ZE0203**

1/10/50/150

15 27 101 400

ZE0203



## Light sources

### LED tubes, tubes

#### PROFI PLUS

- designed for professional replacement of fluorescent tubes
- high luminous efficacy up to 150 lm/W
- high energy saving
- increased service life
- 5 years warranty
- use: administrative and industrial premises

- shape: T8
- luminous flux: 1 100 lm
- color temperature: 4 000 K
- power: 7.3 W
- luminous efficacy: 151 lm/W
- energy efficiency class: D
- beam angle: 260°
- color rendering index (CRI): Ra >80
- voltage: 230 V~/50 Hz
- dimensions: 27 × 603 × 27 mm
- packaging: 10 pcs, small box

**Z73215**

10/-/-/10

15 35 235 000

Z73215



- shape: T8
- luminous flux: 1 100 lm
- color temperature: 6 500 K
- power: 7.3 W
- luminous efficacy: 151 lm/W
- energy efficiency class: D
- beam angle: 260°
- color rendering index (CRI): Ra >80
- voltage: 230 V~/50 Hz

- dimensions: 27 × 603 × 27 mm
- packaging: 10 pcs, small box



**Z73216** 10/-/-/10  
15 35 236 000 Z73216

- shape: T8
- luminous flux: 2 100 lm
- color temperature: 4 000 K
- power: 14 W
- luminous efficacy: 150 lm/W
- energy efficiency class: D
- beam angle: 260°
- color rendering index (CRI): Ra >80
- voltage: 230 V~/50 Hz

- dimensions: 27 × 1213 × 27 mm
- packaging: 10 pcs, small box



**Z73225** 10/-/-/10  
15 35 237 000 Z73225

- shape: T8
- luminous flux: 2 100 lm
- color temperature: 6 500 K
- power: 14 W
- luminous efficacy: 150 lm/W
- energy efficiency class: D
- beam angle: 260°
- color rendering index (CRI): Ra >80
- voltage: 230 V~/50 Hz

- dimensions: 27 × 1213 × 27 mm
- packaging: 10 pcs, small box



**Z73226** 10/-/-/10  
15 35 238 000 Z73226

- shape: T8
- luminous flux: 3 100 lm
- color temperature: 4 000 K
- power: 20.6 W
- luminous efficacy: 150 lm/W
- energy efficiency class: D
- beam angle: 260°
- color rendering index (CRI): Ra >80
- voltage: 230 V~/50 Hz

- dimensions: 27 × 1514 × 27 mm
- packaging: 10 pcs, small box



**Z73235** 10/-/-/10  
15 35 239 000 Z73235

- shape: T8
- luminous flux: 3 100 lm
- color temperature: 6 500 K
- power: 20.6 W
- luminous efficacy: 150 lm/W
- energy efficiency class: D
- beam angle: 260°
- color rendering index (CRI): Ra >80
- voltage: 230 V~/50 Hz

- dimensions: 27 × 1514 × 27 mm
- packaging: 10 pcs, small box



**Z73236** 10/-/-/10  
15 35 240 000 Z73236

## BASIC

- designed to replace conventional fluorescent tubes
- they are characterized by luminous efficacy up to 100 lm/W
- high energy saving
- long service life
- favourable price/quality ratio
- use: administrative and industrial premises

- shape: T8
- luminous flux: 900 lm
- color temperature: 4 000 K
- power: 9.4 W
- luminous efficacy: 96 lm/W
- energy efficiency class: F
- beam angle: 260°
- color rendering index (CRI): Ra >80
- voltage: 230 V~/50 Hz
- dimensions: 600 × 26 × 26 mm
- packaging: 25 pc, small box



**Z73113** 25/-/-/25  
15 35 241 000 Z73113



- shape: T8
- luminous flux: 900 lm
- color temperature: 6 500 K
- power: 9.4 W
- luminous efficacy: 96 lm/W
- energy efficiency class: F
- beam angle: 260°
- color rendering index (CRI): Ra >80
- voltage: 230 V~/50 Hz
- dimensions: 600 × 26 × 26 mm
- packaging: 25 pc, small box



**Z73114** 25/-/-/25  
15 35 242 000 Z73114



- shape: T8
- luminous flux: 1 800 lm
- color temperature: 4 000 K
- power: 17.8 W
- luminous efficacy: 101 lm/W
- energy efficiency class: F
- beam angle: 260°
- color rendering index (CRI): Ra >80
- voltage: 230 V~/50 Hz
- dimensions: 1 200 × 26 × 26 mm
- packaging: 25 pc, small box



**Z73123** 25/-/-/25  
15 35 243 000 Z73123



- shape: T8
- luminous flux: 1 800 lm
- color temperature: 6 500 K
- power: 17.8 W
- luminous efficacy: 101 lm/W
- energy efficiency class: F
- beam angle: 260°
- color rendering index (CRI): Ra >80
- voltage: 230 V~/50 Hz
- dimensions: 1 200 × 26 × 26 mm
- packaging: 25 pc, small box



**Z73124** 25/-/-/25  
15 35 244 000 Z73124



- shape: T8
- luminous flux: 2 500 lm
- color temperature: 4 000 K
- power: 24.3 W
- luminous efficacy: 103 lm/W
- energy efficiency class: F
- beam angle: 260°
- color rendering index (CRI): Ra >80
- voltage: 230 V~/50 Hz
- dimensions: 1 500 × 26 × 26 mm
- packaging: 25 pc, small box

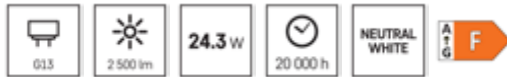

**Z73133** 25/-/-/25  
15 35 245 000 Z73133

- shape: T8
- luminous flux: 2 500 lm
- color temperature: 6 500 K
- power: 24.3 W
- luminous efficacy: 103 lm/W
- energy efficiency class: F
- beam angle: 260°
- color rendering index (CRI): Ra >80
- voltage: 230 V~/50 Hz
- dimensions: 1 500 × 26 × 26 mm
- packaging: 25 pc, small box

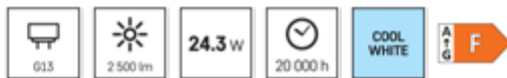

**Z73134** 25/-/-/25  
15 35 246 000 Z73134

## Luminaires

## Highbays

## PROFI PLUS

### ASTER

### PROFI PLUS

- for professional industrial installations at high heights
- Osram branded LED chips with a luminous efficacy of 180 lm/W
- IP65 rating ensures water resistance
- outstanding performance and light quality – CRI > 80
- option for dimming using accessories
- 5 years warranty
- use: industrial and warehouse buildings, large halls

- power: 100 W
- luminous flux: 18 000 lm
- color temperature: 4 000 K
- light color: neutral white
- color rendering index (CRI): Ra > 80
- voltage: 220–240 V~
- IP rating: IP65
- beam angle: 60°
- dimensions: 265 × 163 mm in diameter
- supply cable length: 30 cm
- lead-in cable material: rubber
- body material: aluminum
- mechanical impact protection: IK08
- packaging: 1 pc, box



**ZU310.6** 1/-/-/1  
15 46 139 000 ZU310.6



- power: 100 W
- luminous flux: 18 000 lm
- color temperature: 4 000 K
- light color: neutral white
- color rendering index (CRI): Ra > 80
- voltage: 220-240 V~
- IP rating: IP65
- beam angle: 90°
- dimensions: 265 × 163 mm in diameter

- supply cable length: 30 cm
- lead-in cable material: rubber
- body material: aluminum
- mechanical impact protection: IK08
- packaging: 1 pc, box



**ZU310.9** 1/-/-/1  
15 46 139 100 ZU310.9

- power: 100 W
- luminous flux: 18 000 lm
- color temperature: 4 000 K
- light color: neutral white
- color rendering index (CRI): Ra > 80
- voltage: 220-240 V~
- IP rating: IP65
- beam angle: 120°
- dimensions: 265 × 163 mm in diameter

- supply cable length: 30 cm
- lead-in cable material: rubber
- body material: aluminum
- mechanical impact protection: IK08
- packaging: 1 pc, box



**ZU310.12** 1/-/-/1  
15 46 139 200 ZU310.12

- power: 150 W
- luminous flux: 27 000 lm
- color temperature: 4 000 K
- light color: neutral white
- color rendering index (CRI): Ra > 80
- voltage: 220-240 V~
- IP rating: IP65
- beam angle: 60°
- dimensions: 300 × 173 mm in diameter

- supply cable length: 30 cm
- lead-in cable material: rubber
- body material: aluminum
- mechanical impact protection: IK08
- packaging: 1 pc, box



**ZU315.6** 1/-/-/1  
15 46 139 300 ZU315.6

- power: 150 W
- luminous flux: 27 000 lm
- color temperature: 4 000 K
- light color: neutral white
- color rendering index (CRI): Ra > 80
- voltage: 220-240 V~
- IP rating: IP65
- beam angle: 90°
- dimensions: 300 × 173 mm in diameter

- supply cable length: 30 cm
- lead-in cable material: rubber
- body material: aluminum
- mechanical impact protection: IK08
- packaging: 1 pc, box



**ZU315.9** 1/-/-/1  
15 46 139 400 ZU315.9

- power: 150 W
- luminous flux: 27 000 lm
- color temperature: 4 000 K
- light color: neutral white
- color rendering index (CRI): Ra > 80
- voltage: 220-240 V~
- IP rating: IP65
- beam angle: 120°
- dimensions: 300 × 173 mm in diameter

- supply cable length: 30 cm
- lead-in cable material: rubber
- body material: aluminum
- mechanical impact protection: IK08
- packaging: 1 pc, box



**ZU315.12** 1/-/-/1  
15 46 139 500 ZU315.12



www.emos.eu

Order Code  
Item Number

Packaging  
Type

- power: 200 W
- luminous flux: 36 000 lm
- color temperature: 4 000 K
- light color: neutral white
- color rendering index (CRI): Ra > 80
- voltage: 220-240 V~
- IP rating: IP65
- beam angle: 60°
- dimensions: 340 × 178 mm in diameter
- supply cable length: 30 cm
- lead-in cable material: rubber
- body material: aluminum
- mechanical impact protection: IK08
- packaging: 1 pc, box



200 W	36 000 lm	IP65	IK08	60°	4 000 K NEUTRAL WHITE	5 YEARS WARRANTY
-------	-----------	------	------	-----	-----------------------------	------------------------



<b>ZU320.6</b>	1/-/-/1
15 46 139 600	ZU320.6

- power: 200 W
- luminous flux: 36 000 lm
- color temperature: 4 000 K
- light color: neutral white
- color rendering index (CRI): Ra > 80
- voltage: 220-240 V~
- IP rating: IP65
- beam angle: 90°
- dimensions: 340 × 178 mm in diameter
- supply cable length: 30 cm
- lead-in cable material: rubber
- body material: aluminum
- mechanical impact protection: IK08
- packaging: 1 pc, box



200 W	36 000 lm	IP65	IK08	90°	4 000 K NEUTRAL WHITE	5 YEARS WARRANTY
-------	-----------	------	------	-----	-----------------------------	------------------------



<b>ZU320.9</b>	1/-/-/1
15 46 139 700	ZU320.9

- power: 200 W
- luminous flux: 36 000 lm
- color temperature: 4 000 K
- light color: neutral white
- color rendering index (CRI): Ra > 80
- voltage: 220-240 V~
- IP rating: IP65
- beam angle: 120°
- dimensions: 340 × 178 mm in diameter
- supply cable length: 30 cm
- lead-in cable material: rubber
- body material: aluminum
- mechanical impact protection: IK08
- packaging: 1 pc, box



200 W	36 000 lm	IP65	IK08	120°	4 000 K NEUTRAL WHITE	5 YEARS WARRANTY
-------	-----------	------	------	------	-----------------------------	------------------------



<b>ZU320.12</b>	1/-/-/1
15 46 139 800	ZU320.12

## Luminaires

## Highbays

## PROFI

## CORUS

## PROFI

- for industrial installations at high heights
- IP65 rating ensures water resistance
- outstanding performance and light quality – CRI > 80
- 5 years warranty
- use: industrial and warehouse buildings, large halls

- power: 83 W
- luminous flux: 10 000 lm
- color temperature: 4 000 K
- light color: neutral white
- color rendering index (CRI): Ra > 80
- voltage: 220–240 V
- IP rating: IP65
- beam angle: 110°
- dimensions: diameter 220 × 50 mm

- supply cable length: 30 cm
- lead-in cable material: rubber
- body material: aluminum
- mechanical impact protection: IK06
- packaging: 1 pc, box

**ZU083**

1/-/-/3

15 46 138 000

ZU083

- power: 133 W
- luminous flux: 16 000 lm
- color temperature: 4 000 K
- light color: neutral white
- color rendering index (CRI): Ra > 80
- voltage: 220–240 V
- IP rating: IP65
- beam angle: 110°
- dimensions: diameter 260 × 53 mm

- supply cable length: 30 cm
- lead-in cable material: rubber
- body material: aluminum
- mechanical impact protection: IK06
- packaging: 1 pc, box

**ZU133**

1/-/-/3

15 46 138 100

ZU133

- power: 166 W
- luminous flux: 20 000 lm
- color temperature: 4 000 K
- light color: neutral white
- color rendering index (CRI): Ra > 80
- voltage: 220–240 V
- IP rating: IP65
- beam angle: 110°
- dimensions: diameter 300 × 54 mm

- supply cable length: 30 cm
- lead-in cable material: rubber
- body material: aluminum
- mechanical impact protection: IK06
- packaging: 1 pc, box

**ZU166**

1/-/-/3

15 46 138 200

ZU166

- power: 225 W
- luminous flux: 27 000 lm
- color temperature: 4 000 K
- light color: neutral white
- color rendering index (CRI): Ra > 80
- voltage: 220-240 V
- IP rating: IP65
- beam angle: 110°
- dimensions: diameter 340 × 54 mm
- supply cable length: 30 cm
- lead-in cable material: rubber
- body material: aluminum
- mechanical impact protection: IK06
- packaging: 1 pc, box







**ZU225** 1/-/-/3  
15 46 138 300 ZU225

## Luminaires

## Highbays

## Accessories

**ZU9001** 1/-/-/144  
15 46 009 001 ZU9001

product: 0-10 V converter for Highbay = dimensions: 55 × 29 mm in diameter = material: plastic (PC) + metal = designed for: Highbay line ASTER = packaging: 1 ks, box



**ZU9002** 1/-/-/144  
15 46 009 002 ZU9002





product: DALI converter for Highbay = dimensions: 55 × 29 mm in diameter = material: plastic (PC) + metal = designed for: Highbay line ASTER = packaging: 1 ks, box

**ZU9902** 1/-/-/20  
15 46 009 902 ZU9902

product: bracket for Highbay = dimensions: 254 × 115 × 50 mm = material: aluminum = designed for: Highbay line ASTER = color: black = packaging: 1 pc, packet

**ZU9003** 1/-/-/96  
15 46 009 003 ZU9003





product: PIR sensor for highbay ASTER = dimensions: diameter 55 × 40 mm = material: plastic (PC) + metal = designed for: Highbay line ASTER = color: white = packaging: 1 ks, box





**ZU9004** 1/-/-/144  
15 46 009 004 ZU9004





product: MW sensor for highbay ASTER = dimensions: 55 × 29 mm in diameter = material: plastic (PC) + metal = designed for: Highbay line ASTER = color: white = packaging: 1 ks, box

**ZU9005** 1/-/-/81  
15 46 009 005 ZU9005





product: sensor settings controller for Highbay ASTER = dimensions: 125 × 70 × 25 mm = material: plastic = designed for: Highbay line ASTER = color: white = packaging: 1 ks, box

## Luminaires

## Dustproofs

## PROFI PLUS

### MISTY

### PROFI PLUS

- designed for professional industrial installations
- replace older fluorescent luminaires
- modern design with high luminous efficacy up to 145 lm/W
- long life and instant 100% output
- energy saving up to 50% compared to fluorescent luminaires
- IP66 protection guarantees water resistance
- 5 years warranty
- use: industrial buildings, garages, corridors, workshops

- dimensions: 1 220 × 85 × 80 mm
- power: 21–26–31–35 W
- luminous flux: 3 300–5 600 lm
- color temperature: 4 000 K
- color rendering index (CRI): Ra >80
- beam angle: 120°
- IP rating: IP66
- through-wiring
- working temperature range: -20 °C to +40 °C

- clip material: stainless steel
- voltage: 220–240 V
- protection class: I
- packaging: 1 pc, box









**ZT1521** 1/-/-/9  
15 46 138 400 ZT1521

- dimensions: 1 220 × 85 × 80 mm
- power: 24–29–34–38 W
- luminous flux: 3 300–5 600 lm
- color temperature: 4 000–6 500 K
- color rendering index (CRI): Ra >80
- beam angle: 120°
- IP rating: IP66
- through-wiring
- working temperature range: -20 °C to +40 °C

- clip material: stainless steel
- voltage: 220–240 V
- protection class: I
- lumen output in emergency mode: 700 lm
- backup time: 3 hours
- battery warranty: 2 years
- packaging: 1 pc, box











**ZT1521E** 1/-/-/9  
15 46 138 401 ZT1521E



www.emos.eu

Order Code  
Item Number

Packaging  
Type

- dimensions: 1 220 × 85 × 80 mm
- power: 21–26–31–35 W
- luminous flux: 3 300–5 600 lm
- color temperature: 6 500 K
- color rendering index (CRI): Ra >80
- beam angle: 120°
- IP rating: IP66
- through-wiring
- working temperature range: -20 °C to +40 °C

- clip material: stainless steel
- voltage: 220–240 V
- protection class: I
- packaging: 1 pc, box



**ZT1531** 1/-/-/9  
15 46 138 500 ZT1531

- dimensions: 1 520 × 85 × 80 mm
- power: 29–37–45–51 W
- luminous flux: 4 600–8 150 lm
- color temperature: 4 000 K
- color rendering index (CRI): Ra >80
- beam angle: 120°
- IP rating: IP66
- through-wiring
- working temperature range: -20 °C to +40 °C

- clip material: stainless steel
- voltage: 220–240 V
- protection class: I
- packaging: 1 pc, box



**ZT1621** 1/-/-/9  
15 46 138 600 ZT1621

- dimensions: 1 520 × 85 × 80 mm
- power: 32–40–48–54 W
- luminous flux: 4 600–8 150 lm
- color temperature: 4 000–6 500 K
- color rendering index (CRI): Ra >80
- beam angle: 120°
- IP rating: IP66
- through-wiring
- working temperature range: -20 °C to +40 °C

- clip material: stainless steel
- voltage: 220–240 V
- protection class: I
- lumen output in emergency mode: 700 lm
- backup time: 3 hours
- battery warranty: 2 years
- packaging: 1 pc, box



**ZT1621E** 1/-/-/9  
15 46 138 601 ZT1621E

- dimensions: 1 520 × 85 × 80 mm
- power: 29–37–45–51 W
- luminous flux: 4 600–8 150 lm
- color temperature: 6 500 K
- color rendering index (CRI): Ra >80
- beam angle: 120°
- IP rating: IP66
- through-wiring
- working temperature range: -20 °C to +40 °C

- clip material: stainless steel
- voltage: 220–240 V
- protection class: I
- packaging: 1 pc, box



**ZT1631** 1/-/-/9  
15 46 138 700 ZT1631

- dimensions: 670 × 85 × 80 mm
- power: 10–13–16–18 W
- luminous flux: 1 500–2 700 lm
- color temperature: 4 000–6 500 K
- color rendering index (CRI): Ra >80
- beam angle: 120°
- IP rating: IP66
- through-wiring
- working temperature range: -20 °C to +40 °C

- clip material: stainless steel
- voltage: 220–240 V
- protection class: I
- packaging: 1 pc, box



**ZT1040** 1/-/-/12  
15 46 138 800 ZT1040

## Luminaires

## Dustproofs

## PROFI

## FESTY

## PROFI

- designed for professional industrial installations
- replace older fluorescent luminaires
- characterised by their modern design
- excellent price/quality ratio
- long life and instant 100% output
- energy saving up to 50% compared to fluorescent luminaires
- 5 years warranty
- use: industrial buildings, garages, corridors, workshops

- dimensions: 670 × 64 × 64 mm
- power: 18 W
- luminous flux: 2 200 lm
- color temperature: 4 000 K
- color rendering index (CRI): Ra >80
- beam angle: 120°
- IP rating: IP65
- through-wiring
- working temperature range: -20 °C to +40 °C

- material: plastic (PC)
- clip material: no clips
- voltage: 220–240 V
- protection class: I
- packaging: 1 pc, box



**ZT4320** 1/-/-/10  
15 46 137 700 ZT4320

- dimensions: 1 270 × 64 × 64 mm
- power: 34 W
- luminous flux: 4 100 lm
- color temperature: 4 000 K
- color rendering index (CRI): Ra >80
- beam angle: 120°
- IP rating: IP65
- through-wiring
- working temperature range: -20 °C to +40 °C

- material: plastic (PC)
- clip material: no clips
- voltage: 220–240 V
- protection class: I
- packaging: 1 pc, box



**ZT4420** 1/-/-/10  
15 46 137 800 ZT4420

- dimensions: 1 570 × 64 × 64 mm
- power: 51 W
- luminous flux: 6 000 lm
- color temperature: 4 000 K
- color rendering index (CRI): Ra >80
- beam angle: 120°
- IP rating: IP65
- through-wiring
- working temperature range: -20 °C to +40 °C

- material: plastic (PC)
- clip material: no clips
- voltage: 220–240 V
- protection class: I
- packaging: 1 pc, box



**ZT4520** 1/-/-/10  
15 46 137 900 ZT4520

# Luminaires

## Dustproofs

### ESSENTIAL

## DUSTY

## ESSENTIAL

- designed for standard industrial installations
- replace older fluorescent luminaires
- long life and instant 100% output
- energy saving up to 50% compared to fluorescent luminaires
- IP65 protection guarantees water resistance
- possibility of through wiring
- 3 years warranty
- use: industrial buildings, garages, corridors, workshops

- dimensions: 754 × 53 × 35 mm
- power: 18 W
- luminous flux: 1 700 lm
- color temperature: 4 000 K
- color rendering index (CRI): Ra >80
- beam angle: 120°
- IP rating: IP65
- through-wiring
- working temperature range: -15 °C to +35 °C

- material: plastic (PC)
- clip material: no clips
- voltage: 220–240 V
- protection class: II
- packaging: 1 pc, blister



**ZT3020** 1/-/-/20  
15 46 135 700 ZT3020

- dimensions: 1 284 × 53 × 35 mm
- power: 37 W
- luminous flux: 3 800 lm
- color temperature: 4 000 K
- color rendering index (CRI): Ra >80
- beam angle: 120°
- IP rating: IP65
- through-wiring
- working temperature range: -15 °C to +35 °C

- material: plastic (PC)
- clip material: no clips
- voltage: 220–240 V
- protection class: II
- packaging: 1 pc, blister



**ZT3120** 1/-/-/20  
15 46 135 800 ZT3120

- dimensions: 1 564 × 53 × 35 mm
- power: 45 W
- luminous flux: 4 500 lm
- color temperature: 4 000 K
- color rendering index (CRI): Ra >80
- beam angle: 120°
- IP rating: IP65
- through-wiring
- working temperature range: -20 °C to +35 °C

- material: plastic (PC)
- clip material: no clips
- voltage: 220–240 V
- protection class: II
- packaging: 1 pc, blister



**ZT3220** 1/-/-/20  
15 46 135 900 ZT3220



# Luminaires

## Street Lights

### PROFI

## SOLIS

## PROFI

- street lights
- durable aluminium body
- lighting efficiency up to 120 lm/W
- high operating cost savings compared to sodium lamps
- 3 years warranty
- use: permanent outdoor lighting

- power: 30 W
- luminous flux: 3 600 lm
- color temperature: 3 000 K
- light color: warm white
- color rendering index (CRI): Ra > 80
- voltage: 220–240 V
- IP rating: IP65
- beam angle: 130 × 60°
- dimensions: 412 × 146 × 63 mm

- supply cable length: 30 cm
- lead-in cable material: rubber
- body material: aluminum
- mechanical impact protection: IK08
- packaging: 1 pc, box

**Z00303**

1/-/-/4

15 36 000 000

Z00303

- power: 30 W
- luminous flux: 3 600 lm
- color temperature: 4 000 K
- light color: neutral white
- color rendering index (CRI): Ra > 80
- voltage: 220–240 V
- IP rating: IP65
- beam angle: 130 × 60°
- dimensions: 412 × 146 × 63 mm

- supply cable length: 30 cm
- lead-in cable material: rubber
- body material: aluminum
- mechanical impact protection: IK08
- packaging: 1 pc, box

**Z00304**

1/-/-/4

15 36 020 000

Z00304

- power: 50 W
- luminous flux: 6 000 lm
- color temperature: 4 000 K
- light color: neutral white
- color rendering index (CRI): Ra > 80
- voltage: 220–240 V
- IP rating: IP65
- beam angle: 130 × 60°
- dimensions: 412 × 146 × 63 mm

- supply cable length: 30 cm
- lead-in cable material: rubber
- body material: aluminum
- mechanical impact protection: IK08
- packaging: 1 pc, box

**Z00504**

1/-/-/4

15 36 020 001

Z00504



www.emos.eu

Order Code  
Item Number

Packaging  
Type

- power: 70 W
- luminous flux: 8 400 lm
- color temperature: 4 000 K
- light color: neutral white
- color rendering index (CRI): Ra > 80
- voltage: 220-240 V
- IP rating: IP65
- beam angle: 130 × 60°
- dimensions: 515 × 175 × 63 mm
- supply cable length: 30 cm
- lead-in cable material: rubber
- body material: aluminum
- mechanical impact protection: IK08
- packaging: 1 pc, box



**Z00704** 1/-/-/2  
15 36 020 002 Z00704

# Luminaires

## Floodlights

### PROFI PLUS

## AVENO

## PROFI PLUS

- combine top performance with a modern look
- provide a luminous efficiency of up to 160 lm/W
- the robust and well-made aluminium body
- adjustable wattage on selected models
- cost savings of up to 90% compared to halogen floodlights
- continuously dimmable
- 5 years warranty
- use: permanent illumination of indoor and outdoor areas

- power: 20 W
- luminous flux: 2 900 lm
- color temperature: 4 000 K
- light color: neutral white
- color rendering index (CRI): Ra > 80
- voltage: 220-240 V
- IP rating: IP66
- beam angle: 100°
- dimensions: 175 × 165 × 34 mm
- supply cable length: 1 m
- lead-in cable material: rubber
- body material: aluminum
- mechanical impact protection: IK08
- packaging: 1 pc, box



**ZS2413** 1/-/-/10  
15 31 241 300 ZS2413

- power: 30 W
- luminous flux: 4 500 lm
- color temperature: 4 000 K
- light color: neutral white
- color rendering index (CRI): Ra > 80
- voltage: 220-240 V
- IP rating: IP66
- beam angle: 100°
- dimensions: 196 × 183 × 37 mm
- supply cable length: 1 m
- lead-in cable material: rubber
- body material: aluminum
- mechanical impact protection: IK08
- packaging: 1 pc, box



**ZS2423** 1/-/-/10  
15 31 242 300 ZS2423



www.emos.eu

Order Code  
Item Number

Packaging  
Type

- power: 48 W
- luminous flux: 7 200 lm
- color temperature: 4 000 K
- light color: neutral white
- color rendering index (CRI): Ra > 80
- voltage: 220-240 V
- IP rating: IP66
- beam angle: 100°
- dimensions: 247 × 183 × 37 mm

- supply cable length: 1 m
- lead-in cable material: rubber
- body material: aluminum
- mechanical impact protection: IK08
- packaging: 1 pc, box



**ZS2433** 1/-/-/10  
15 31 243 300 ZS2433

- power: 100 W
- luminous flux: 16 000 lm
- color temperature: 4 000 K
- light color: neutral white
- color rendering index (CRI): Ra > 80
- voltage: 100-277 V
- IP rating: IP66
- beam angle: 90°
- dimensions: 294 × 270 × 70 mm

- supply cable length: 1 m
- lead-in cable material: rubber
- body material: aluminum
- mechanical impact protection: IK08
- packaging: 1 pc, box



**ZS2443** 1/-/-/1  
15 31 244 300 ZS2443

- power: 100 W
- luminous flux: 15 500 lm
- color temperature: 4 000 K
- light color: neutral white
- color rendering index (CRI): Ra > 80
- voltage: 100-277 V
- IP rating: IP66
- beam angle: 60° × 135°
- dimensions: 294 × 270 × 70 mm

- supply cable length: 1 m
- lead-in cable material: rubber
- body material: aluminum
- mechanical impact protection: IK08
- packaging: 1 pc, box



**ZS2443A** 1/-/-/1  
15 31 244 310 ZS2443A

- power: 150 W
- luminous flux: 24 000 lm
- color temperature: 4 000 K
- light color: neutral white
- color rendering index (CRI): Ra > 80
- voltage: 100-277 V
- IP rating: IP66
- beam angle: 90°
- dimensions: 294 × 345 × 70 mm

- supply cable length: 1 m
- lead-in cable material: rubber
- body material: aluminum
- mechanical impact protection: IK08
- packaging: 1 pc, box



**ZS2453** 1/-/-/1  
15 31 245 300 ZS2453

- power: 150 W
- luminous flux: 23 250 lm
- color temperature: 4 000 K
- light color: neutral white
- color rendering index (CRI): Ra > 80
- voltage: 100-277 V
- IP rating: IP66
- beam angle: 60° × 135°
- dimensions: 294 × 345 × 70 mm

- supply cable length: 1 m
- lead-in cable material: rubber
- body material: aluminum
- mechanical impact protection: IK08
- packaging: 1 pc, box



**ZS2453A** 1/-/-/1  
15 31 245 310 ZS2453A



www.emos.eu

Order Code  
Item Number

Packaging  
Type

- power: 200 W
- luminous flux: 32 000 lm
- color temperature: 4 000 K
- light color: neutral white
- color rendering index (CRI): Ra > 80
- voltage: 100-277 V
- IP rating: IP66
- beam angle: 90°
- dimensions: 368 × 388 × 75 mm
- supply cable length: 1 m
- lead-in cable material: rubber
- body material: aluminum
- mechanical impact protection: IK08
- packaging: 1 pc, box



200 W	32 000 lm	IP66	IK08	Dimmable	4 000 K NEUTRAL WHITE	5 YEARS WARRANTY
-------	-----------	------	------	----------	-----------------------------	------------------------



<b>ZS2463</b>	1/-/-/1
15 31 246 300	ZS2463

- power: 200 W
- luminous flux: 31 000 lm
- color temperature: 4 000 K
- light color: neutral white
- color rendering index (CRI): Ra > 80
- voltage: 100-277 V
- IP rating: IP66
- beam angle: 60° × 135°
- dimensions: 368 × 388 × 70 mm
- supply cable length: 1 m
- lead-in cable material: rubber
- body material: aluminum
- mechanical impact protection: IK08
- packaging: 1 pc, box



200 W	31 000 lm	IP66	IK08	Dimmable	4 000 K NEUTRAL WHITE	5 YEARS WARRANTY
-------	-----------	------	------	----------	-----------------------------	------------------------



<b>ZS2463A</b>	1/-/-/1
15 31 246 310	ZS2463A

- power: 300 W
- luminous flux: 48 000 lm
- color temperature: 4 000 K
- light color: neutral white
- color rendering index (CRI): Ra > 80
- voltage: 100-277 V
- IP rating: IP66
- beam angle: 90°
- dimensions: 432 × 425 × 75 mm
- supply cable length: 1 m
- lead-in cable material: rubber
- body material: aluminum
- mechanical impact protection: IK08
- packaging: 1 pc, box



300 W	48 000 lm	IP66	IK08	Dimmable	4 000 K NEUTRAL WHITE	5 YEARS WARRANTY
-------	-----------	------	------	----------	-----------------------------	------------------------



<b>ZS2473</b>	1/-/-/1
15 31 247 300	ZS2473



## Luminaires

## Floodlights

## PROFI

## INOVO

## PROFI

- cost savings of up to 95% compared to halogen spotlights
- professional workmanship for the most demanding conditions
- easy cable connection using the cable connector (included)
- motion sensor with dimming and run time adjustment
- 5 years warranty
- use: permanent illumination of indoor and outdoor areas

- power: 10 W
- luminous flux: 1 100 lm
- color temperature: 4 000 K
- light color: neutral white
- color rendering index (CRI): Ra > 80
- voltage: 220–240 V~
- IP rating: IP65
- beam angle: 120°
- dimensions: 95 × 70 × 27 mm

- supply cable length: 30 cm
- lead-in cable material: rubber
- body material: aluminum
- mechanical impact protection: IK07
- packaging: 1 pc, box



**ZS2612** 1/-/-/30  
15 31 242 612 ZS2612

- power: 20 W
- luminous flux: 2 200 lm
- color temperature: 4 000 K
- light color: neutral white
- color rendering index (CRI): Ra > 80
- voltage: 220–240 V~
- IP rating: IP65
- beam angle: 120°
- dimensions: 135 × 95 × 28 mm

- supply cable length: 30 cm
- lead-in cable material: rubber
- body material: aluminum
- mechanical impact protection: IK07
- packaging: 1 pc, box



**ZS2622** 1/-/-/20  
15 31 242 622 ZS2622

- power: 30 W
- luminous flux: 3 300 lm
- color temperature: 4 000 K
- light color: neutral white
- color rendering index (CRI): Ra > 80
- voltage: 220–240 V~
- IP rating: IP65
- beam angle: 120°
- dimensions: 160 × 110 × 28 mm

- supply cable length: 30 cm
- lead-in cable material: rubber
- body material: aluminum
- mechanical impact protection: IK07
- packaging: 1 pc, box



**ZS2632** 1/-/-/10  
15 31 242 632 ZS2632



www.emos.eu

Order Code  
Item Number

Packaging  
Type

- power: 50 W
- luminous flux: 5 500 lm
- color temperature: 4 000 K
- light color: neutral white
- color rendering index (CRI): Ra > 80
- voltage: 220-240 V~
- IP rating: IP65
- beam angle: 120°
- dimensions: 200 × 145 × 28 mm

- supply cable length: 30 cm
- lead-in cable material: rubber
- body material: aluminum
- mechanical impact protection: IK07
- packaging: 1 pc, box



**ZS2642** 1/-/-10  
15 31 242 642 ZS2642

- power: 100 W
- luminous flux: 11 000 lm
- color temperature: 4 000 K
- light color: neutral white
- color rendering index (CRI): Ra > 80
- voltage: 220-240 V~
- IP rating: IP65
- beam angle: 120°
- dimensions: 300 × 220 × 42 mm

- supply cable length: 30 cm
- lead-in cable material: rubber
- body material: aluminum
- mechanical impact protection: IK08
- packaging: 1 pc, box



**ZS2652** 1/-/-5  
15 31 242 652 ZS2652

- power: 150 W
- luminous flux: 16 500 lm
- color temperature: 4 000 K
- light color: neutral white
- color rendering index (CRI): Ra > 80
- voltage: 220-240 V~
- IP rating: IP65
- beam angle: 120°
- dimensions: 335 × 270 × 43 mm

- supply cable length: 30 cm
- lead-in cable material: rubber
- body material: aluminum
- mechanical impact protection: IK08
- packaging: 1 pc, box



**ZS2662** 1/-/-3  
15 31 242 662 ZS2662

- power: 200 W
- luminous flux: 22 000 lm
- color temperature: 4 000 K
- light color: neutral white
- color rendering index (CRI): Ra > 80
- voltage: 220-240 V~
- IP rating: IP65
- beam angle: 120°
- dimensions: 390 × 300 × 49 mm

- supply cable length: 30 cm
- lead-in cable material: rubber
- body material: aluminum
- mechanical impact protection: IK08
- packaging: 1 pc, box



**ZS2672** 1/-/-2  
15 31 242 672 ZS2672

- power: 10 W
- luminous flux: 1 100 lm
- color temperature: 4 000 K
- light color: neutral white
- color rendering index (CRI): Ra > 80
- voltage: 220-240 V~
- IP rating: IP65
- beam angle: 120°
- dimensions: 95 × 70 × 27 mm

- supply cable length: 30 cm
- detection range of PIR Sensor: 10 m
- lead-in cable material: rubber
- body material: aluminum
- mechanical impact protection: IK06
- packaging: 1 pc, box



**ZS2712** 1/-/-20  
15 31 242 712 ZS2712

- power: 20 W
- luminous flux: 2 200 lm
- color temperature: 4 000 K
- light color: neutral white
- color rendering index (CRI): Ra > 80
- voltage: 220-240 V~
- IP rating: IP65
- beam angle: 120°
- dimensions: 135 × 95 × 28 mm

- supply cable length: 30 cm
- detection range of PIR Sensor: 10 m
- lead-in cable material: rubber
- body material: aluminum
- mechanical impact protection: IK06
- packaging: 1 pc, box



**ZS2722** 1/-/-/20  
15 31 242 722 ZS2722

- power: 30 W
- luminous flux: 3 300 lm
- color temperature: 4 000 K
- light color: neutral white
- color rendering index (CRI): Ra > 80
- voltage: 220-240 V~
- IP rating: IP65
- beam angle: 120°
- dimensions: 160 × 110 × 28 mm

- supply cable length: 30 cm
- detection range of PIR Sensor: 10 m
- lead-in cable material: rubber
- body material: aluminum
- mechanical impact protection: IK06
- packaging: 1 pc, box



**ZS2732** 1/-/-/10  
15 31 242 732 ZS2732

- power: 50 W
- luminous flux: 5 500 lm
- color temperature: 4 000 K
- light color: neutral white
- color rendering index (CRI): Ra > 80
- voltage: 220-240 V~
- IP rating: IP65
- beam angle: 120°
- dimensions: 200 × 145 × 28 mm

- supply cable length: 30 cm
- detection range of PIR Sensor: 10 m
- lead-in cable material: rubber
- body material: aluminum
- mechanical impact protection: IK06
- packaging: 1 pc, box



**ZS2742** 1/-/-/10  
15 31 242 742 ZS2742

## Luminaires

## Floodlights

## CLASSIC

## ILIO

## CLASSIC

- unique design with a milky PC diffuser
- cost savings of up to 90% compared to halogen spotlights
- IP65 protection guarantees water resistance
- easy cable connection to the terminal block
- bevelled bracket allows easy installation on the wall
- 3 years warranty
- use: facades, private and public spaces, sales stands

- power: 10,5 W
- luminous flux: 950 lm
- color temperature: 4 000 K
- light color: neutral white
- color rendering index (CRI): Ra > 80
- voltage: 220-240 V~
- IP rating: IP65
- beam angle: 120°
- dimensions: 114 × 99 × 51 mm

- body material: aluminum
- mechanical impact protection: IK08
- packaging: 1 pc, box

**ZS2510**

1/-/-/20

15 31 252 510

ZS2510

- power: 21 W
- luminous flux: 1 900 lm
- color temperature: 4 000 K
- light color: neutral white
- color rendering index (CRI): Ra > 80
- voltage: 220-240 V~
- IP rating: IP65
- beam angle: 120°
- dimensions: 147 × 123 × 55 mm

- body material: aluminum
- mechanical impact protection: IK08
- packaging: 1 pc, box

**ZS2520**

1/-/-/20

15 31 252 520

ZS2520

- power: 31 W
- luminous flux: 2 800 lm
- color temperature: 4 000 K
- light color: neutral white
- color rendering index (CRI): Ra > 80
- voltage: 220-240 V~
- IP rating: IP65
- beam angle: 120°
- dimensions: 178 × 148 × 55 mm

- body material: aluminum
- mechanical impact protection: IK08
- packaging: 1 pc, box

**ZS2530**

1/-/-/12

15 31 252 530

ZS2530



- power: 51 W
- luminous flux: 4 600 lm
- color temperature: 4 000 K
- light color: neutral white
- color rendering index (CRI): Ra > 80
- voltage: 220-240 V~
- IP rating: IP65
- beam angle: 120°
- dimensions: 208 × 170 × 55 mm

- body material: aluminum
- mechanical impact protection: IK08
- packaging: 1 pc, box



**ZS2540**  
15 31 252 540

1/-/-10  
ZS2540

- power: 10,5 W
- luminous flux: 950 lm
- color temperature: 4 000 K
- light color: neutral white
- color rendering index (CRI): Ra > 80
- voltage: 220-240 V~
- IP rating: IP44
- beam angle: 120°
- dimensions: 114 × 162 × 75 mm

- detection range of PIR Sensor: 10 m
- body material: aluminum
- mechanical impact protection: IK06
- packaging: 1 pc, box



**ZS2910**  
15 31 252 910

1/-/-18  
ZS2910

- power: 21 W
- luminous flux: 1 900 lm
- color temperature: 4 000 K
- light color: neutral white
- color rendering index (CRI): Ra > 80
- voltage: 220-240 V~
- IP rating: IP44
- beam angle: 120°
- dimensions: 147 × 175 × 75 mm

- detection range of PIR Sensor: 10 m
- lead-in cable material: rubber
- body material: aluminum
- mechanical impact protection: IK06
- packaging: 1 pc, box



**ZS2920**  
15 31 252 920

1/-/-12  
ZS2920

- power: 31 W
- luminous flux: 2 800 lm
- color temperature: 4 000 K
- light color: neutral white
- color rendering index (CRI): Ra > 80
- voltage: 220-240 V~
- IP rating: IP44
- beam angle: 120°
- dimensions: 178 × 201 × 75 mm

- detection range of PIR Sensor: 10 m
- body material: aluminum
- mechanical impact protection: IK06
- packaging: 1 pc, box



**ZS2930**  
15 31 252 930

1/-/-10  
ZS2930

- power: 51 W
- luminous flux: 4 600 lm
- color temperature: 4 000 K
- light color: neutral white
- color rendering index (CRI): Ra > 80
- voltage: 220-240 V~
- IP rating: IP44
- beam angle: 120°
- dimensions: 208 × 223 × 75 mm

- detection range of PIR Sensor: 10 m
- body material: aluminum
- mechanical impact protection: IK06
- packaging: 1 pc, box



**ZS2940**  
15 31 252 940

1/-/-5  
ZS2940

# TAMBO

## CLASSIC

- aluminium with a milky PC diffuser for a pleasantly light
- cost savings of up to 90% compared to halogen spotlights
- IP65 protection guarantees water resistance
- ultra-thin design
- bevelled bracket allows easy installation on the wall
- 3 years warranty
- use: commercial, private buildings and ambient environment

- power: 10,5 W
- luminous flux: 800 lm
- color temperature: 4 000 K
- light color: neutral white
- color rendering index (CRI): Ra > 80
- voltage: 220-240 V~
- IP rating: IP65
- beam angle: 120°
- dimensions: 105 × 102 × 55 mm



- supply cable length: 30 cm
- lead-in cable material: rubber
- body material: aluminum
- mechanical impact protection: IK08
- packaging: 1 pc, box



**ZS2511** 1/-/-14  
15 31 242 511 ZS2511

- power: 20 W
- luminous flux: 1 600 lm
- color temperature: 4 000 K
- light color: neutral white
- color rendering index (CRI): Ra > 80
- voltage: 220-240 V~
- IP rating: IP65
- beam angle: 120°
- dimensions: 135 × 101 × 55 mm



- supply cable length: 30 cm
- lead-in cable material: rubber
- body material: aluminum
- mechanical impact protection: IK08
- packaging: 1 pc, box



**ZS2521** 1/-/-12  
15 31 242 521 ZS2521

- power: 30.5 W
- luminous flux: 2 600 lm
- color temperature: 4 000 K
- light color: neutral white
- color rendering index (CRI): Ra > 80
- voltage: 220-240 V~
- IP rating: IP65
- beam angle: 120°
- dimensions: 165 × 114 × 55 mm



- supply cable length: 30 cm
- lead-in cable material: rubber
- body material: aluminum
- mechanical impact protection: IK08
- packaging: 1 pc, box



**ZS2531** 1/-/-10  
15 31 242 531 ZS2531

- power: 51 W
- luminous flux: 4 300 lm
- color temperature: 4 000 K
- light color: neutral white
- color rendering index (CRI): Ra > 80
- voltage: 220-240 V~
- IP rating: IP65
- beam angle: 120°
- dimensions: 210 × 142 × 55 mm



- supply cable length: 30 cm
- lead-in cable material: rubber
- body material: aluminum
- mechanical impact protection: IK08
- packaging: 1 pc, box



**ZS2541** 1/-/-7  
15 31 242 541 ZS2541



www.emos.eu

Order Code  
Item Number

Packaging  
Type

- power: 10,5 W
- luminous flux: 800 lm
- color temperature: 4 000 K
- light color: neutral white
- color rendering index (CRI): Ra > 80
- voltage: 220-240 V~
- IP rating: IP54
- beam angle: 120°
- dimensions: 105 × 143 × 64 mm

- supply cable length: 30 cm
- detection range of PIR Sensor: 10 m
- lead-in cable material: rubber
- body material: aluminum
- mechanical impact protection: IK06
- packaging: 1 pc, box



**ZS2911** 1/-/-/14  
15 31 242 911 ZS2911

- power: 20 W
- luminous flux: 1 600 lm
- color temperature: 4 000 K
- light color: neutral white
- color rendering index (CRI): Ra > 80
- voltage: 220-240 V~
- IP rating: IP54
- beam angle: 120°
- dimensions: 135 × 165 × 64 mm

- supply cable length: 30 cm
- detection range of PIR Sensor: 10 m
- lead-in cable material: rubber
- body material: aluminum
- mechanical impact protection: IK06
- packaging: 1 pc, box



**ZS2921** 1/-/-/12  
15 31 242 921 ZS2921

- power: 30.5 W
- luminous flux: 2 600 lm
- color temperature: 4 000 K
- light color: neutral white
- color rendering index (CRI): Ra > 80
- voltage: 220-240 V~
- IP rating: IP54
- beam angle: 120°
- dimensions: 165 × 185 × 64 mm

- supply cable length: 30 cm
- detection range of PIR Sensor: 10 m
- lead-in cable material: rubber
- body material: aluminum
- mechanical impact protection: IK06
- packaging: 1 pc, box



**ZS2931** 1/-/-/10  
15 31 242 931 ZS2931

- power: 51 W
- luminous flux: 4 300 lm
- color temperature: 4 000 K
- light color: neutral white
- color rendering index (CRI): Ra > 80
- voltage: 220-240 V~
- IP rating: IP54
- beam angle: 120°
- dimensions: 210 × 217 × 64 mm

- supply cable length: 30 cm
- detection range of PIR Sensor: 10 m
- lead-in cable material: rubber
- body material: aluminum
- mechanical impact protection: IK06
- packaging: 1 pc, box



**ZS2941** 1/-/-/7  
15 31 242 941 ZS2941

## Luminaires

## Floodlights

## ESSENTIAL

## SIMPO

## ESSENTIAL

- motion sensor allows to set the daylight sensor and duration
- cost savings of up to 90% compared to halogen spotlights
- IP44 protection ensures water resistance
- ultra-thin design
- bevelled bracket allows easy installation on the wall
- 3 years warranty
- use: private objects and surrounding environment

- power: 10 W
- luminous flux: 1 000 lm
- color temperature: 4 000 K
- light color: neutral white
- color rendering index (CRI): Ra > 80
- voltage: 220–240 V~
- IP rating: IP65
- beam angle: 120°
- dimensions: 85 × 73 × 25 mm



- supply cable length: 20 cm
- lead-in cable material: rubber
- lead-in cable type: H05RN-F
- body material: aluminum
- packaging: 1 pc, box

4 000 K  
NEUTRAL  
WHITE**ZS2213**

1/-/-48

15 31 221 300

ZS2213

- power: 20 W
- luminous flux: 2 000 lm
- color temperature: 4 000 K
- light color: neutral white
- color rendering index (CRI): Ra > 80
- voltage: 220–240 V~
- IP rating: IP65
- beam angle: 120°
- dimensions: 114 × 92 × 25 mm



- supply cable length: 20 cm
- lead-in cable material: rubber
- lead-in cable type: H05RN-F
- body material: aluminum
- packaging: 1 pc, box

4 000 K  
NEUTRAL  
WHITE**ZS2223**

1/-/-24

15 31 222 300

ZS2223

- power: 30 W
- luminous flux: 3 000 lm
- color temperature: 4 000 K
- light color: neutral white
- color rendering index (CRI): Ra > 80
- voltage: 220–240 V~
- IP rating: IP65
- beam angle: 120°
- dimensions: 143 × 113 × 25 mm



- supply cable length: 20 cm
- lead-in cable material: rubber
- lead-in cable type: H05RN-F
- body material: aluminum
- packaging: 1 pc, box

4 000 K  
NEUTRAL  
WHITE**ZS2233**

1/-/-24

15 31 223 300

ZS2233



- power: 50 W
- luminous flux: 5 000 lm
- color temperature: 4 000 K
- light color: neutral white
- color rendering index (CRI): Ra > 80
- voltage: 220-240 V~
- IP rating: IP65
- beam angle: 120°
- dimensions: 182 × 142 × 27 mm



- supply cable length: 20 cm
- lead-in cable material: rubber
- lead-in cable type: H05RN-F
- body material: aluminum
- packaging: 1 pc, box

4 000 K  
NEUTRAL  
WHITE



**ZS2243**  
15 31 224 300

1/-/-12  
ZS2243

- power: 10 W
- luminous flux: 1 000 lm
- color temperature: 4 000 K
- light color: neutral white
- color rendering index (CRI): Ra > 80
- voltage: 220-240 V~
- IP rating: IP44
- beam angle: 120°
- dimensions: 85 × 141 × 52 mm



- supply cable length: 20 cm
- detection range of PIR Sensor: 8 m
- lead-in cable material: rubber
- lead-in cable type: H05RN-F
- body material: aluminum
- packaging: 1 pc, box

4 000 K  
NEUTRAL  
WHITE



**ZS2313**  
15 31 231 300

1/-/-16  
ZS2313

- power: 20 W
- luminous flux: 2 000 lm
- color temperature: 4 000 K
- light color: neutral white
- color rendering index (CRI): Ra > 80
- voltage: 220-240 V~
- IP rating: IP44
- beam angle: 120°
- dimensions: 114 × 156 × 52 mm



- supply cable length: 20 cm
- detection range of PIR Sensor: 8 m
- lead-in cable material: rubber
- lead-in cable type: H05RN-F
- body material: aluminum
- packaging: 1 pc, box

4 000 K  
NEUTRAL  
WHITE



**ZS2323**  
15 31 232 300

1/-/-20  
ZS2323

- power: 30 W
- luminous flux: 3 000 lm
- color temperature: 4 000 K
- light color: neutral white
- color rendering index (CRI): Ra > 80
- voltage: 220-240 V~
- IP rating: IP44
- beam angle: 120°
- dimensions: 143 × 175 × 52 mm



- supply cable length: 20 cm
- detection range of PIR Sensor: 8 m
- lead-in cable material: rubber
- lead-in cable type: H05RN-F
- body material: aluminum
- packaging: 1 pc, box

4 000 K  
NEUTRAL  
WHITE



**ZS2333**  
15 31 233 300

1/-/-10  
ZS2333

- power: 50 W
- luminous flux: 5 000 lm
- color temperature: 4 000 K
- light color: neutral white
- color rendering index (CRI): Ra > 80
- voltage: 220-240 V~
- IP rating: IP44
- beam angle: 120°
- dimensions: 182 × 199 × 52 mm



- supply cable length: 20 cm
- detection range of PIR Sensor: 8 m
- lead-in cable material: rubber
- lead-in cable type: H05RN-F
- body material: aluminum
- packaging: 1 pc, box

4 000 K  
NEUTRAL  
WHITE



**ZS2343**  
15 31 234 300

1/-/-10  
ZS2343

# Luminaires

# Floodlights

## Accessories

- water resistant connector for connection of 2 three-wire cables
- steel folding tripod as a stand for 2 floodlights
- high enclosure rating of IP68, silicone sealing
- height: 66–180 cm, load capacity max. 4 kg

- voltage: 250 V
- IP rating: IP68
- dimensions: 26 × 70 mm in diameter
- body material: plastic (PA66)
- mechanical impact protection: IK08
- packaging: 1 pc, packet

**ZS9010**

1/-/10/90

15 31 900 010

ZS9010

- voltage: 250 V
- IP rating: IP68
- dimensions: 26 × 90 mm in diameter
- body material: plastic (PA66)
- mechanical impact protection: IK08
- packaging: 1 pc, packet

**ZS9020**

1/-/10/90

15 31 900 020

ZS9020

- voltage: 250 V
- IP rating: IP68
- dimensions: 26 × 90 × 62 mm
- body material: plastic (PA66)
- mechanical impact protection: IK08
- packaging: 1 pc, packet

**ZS9030**

1/-/10/80

15 31 900 030

ZS9030

- dimensions: 140 × 120 × 630 mm
- body material: steel
- packaging: 1 pc, box



<b>ZS9510</b>	1/-/-/4
15 31 950 010	ZS9510

## Luminaires

## Work Lights

## PROFI

### CANNO

### PROFI

- mains powered and suitable for indoor and outdoor use
- robust construction which is shockproof and waterproof
- wide area illumination angle of 360°
- water and impact resistance due to IP54 and IK07 protection
- designed handle and folding design makes easy to transport
- 3 years warranty
- use: construction, house, garage, workshop, car repair shop

- power: 70 W
- luminous flux: 7 000 lm
- color temperature: 4 000 K
- light color: neutral white
- color rendering index (CRI): Ra > 80
- voltage: 220–240 V~
- IP rating: IP54
- beam angle: 360°
- dimensions: 205 × 160 × 880 mm

- supply cable length: 2 m
- number of adapter plugs: 1
- adapter plug type: SCHUKO
- lead-in cable material: rubber
- lead-in cable type: H07RN-F
- body material: plastic (ABS)
- mechanical impact protection: IK07
- packaging: 1 pc, box



<b>ZS3360S</b>	1/-/-/1
15 42 033 601	ZS3360S

## Luminaires

## Work Lights

## CLASSIC

## ILIO

## CLASSIC

- mains powered, suitable for indoor and outdoor use
- robust shockproof and waterproof construction
- wide area illumination angle of 110°
- shockproof and waterproof thanks to IP44 and IK10 protection
- handle and folding design allowing easy reflector transport
- a 3-year warranty
- usage: constructions, houses, garages, workshops, etc.

- power: 21 W
- luminous flux: 1 900 lm
- color temperature: 4 000 K
- light color: neutral white
- color rendering index (CRI): Ra > 80
- voltage: 220–240 V~
- IP rating: IP44
- beam angle: 110°
- dimensions: 215 × 185 × 250 mm

- supply cable length: 1.5 m
- lead-in cable material: rubber
- lead-in cable type: H07RN-F
- body material: aluminum
- mechanical impact protection: IK10
- packaging: 1 pc, box



**ZS3322** 1/-/-/6  
15 42 033 220 ZS3322

- power: 31 W
- luminous flux: 2 800 lm
- color temperature: 4 000 K
- light color: neutral white
- color rendering index (CRI): Ra > 80
- voltage: 220–240 V~
- IP rating: IP44
- beam angle: 110°
- dimensions: 240 × 185 × 275 mm

- supply cable length: 1.5 m
- lead-in cable material: rubber
- lead-in cable type: H07RN-F
- body material: aluminum
- mechanical impact protection: IK10
- packaging: 1 pc, box



**ZS3332** 1/-/-/4  
15 42 033 320 ZS3332

- power: 51 W
- luminous flux: 4 600 lm
- color temperature: 4 000 K
- light color: neutral white
- color rendering index (CRI): Ra > 80
- voltage: 220–240 V~
- IP rating: IP44
- beam angle: 110°
- dimensions: 270 × 185 × 275 mm

- supply cable length: 1.5 m
- lead-in cable material: rubber
- lead-in cable type: H07RN-F
- body material: aluminum
- mechanical impact protection: IK10
- packaging: 1 pc, box



**ZS3342** 1/-/-/4  
15 42 033 420 ZS3342



## HOBBY SLIM

## CLASSIC

- higher coverage for indoor and outdoor lighting
- steel folding tripod
- resistant to low outdoor temperatures or water droplets
- adjustable direction of light wherever needed
- adjustable up to 66–185 cm height
- IP65 protection guarantees water resistance
- usage: constructions, houses, garages, workshops, etc.

- power: 2× 20,5 W
- luminous flux: 2× 1 600 lm
- color temperature: 4 000 K
- light color: neutral white
- color rendering index (CRI): Ra > 80
- voltage: 220–240 V~
- IP rating: IP65
- beam angle: 120°
- dimensions: 860 × 860 × 1 850 mm

- supply cable length: 3 m
- lead-in cable material: rubber
- lead-in cable type: H07RN-F
- body material: aluminum
- mechanical impact protection: IK08
- packaging: 1 pc, box



ZS2221.2

1/-/-/2

15 31 222 120

ZS2221.2

- power: 2× 30 W
- luminous flux: 2× 2 400 lm
- color temperature: 4 000 K
- light color: neutral white
- color rendering index (CRI): Ra > 80
- voltage: 220–240 V~
- IP rating: IP65
- beam angle: 120°
- dimensions: 860 × 860 × 1 850 mm

- supply cable length: 3 m
- lead-in cable material: rubber
- lead-in cable type: H07RN-F
- body material: aluminum
- mechanical impact protection: IK08
- packaging: 1 pc, box



ZS2231.2

1/-/-/2

15 31 223 120

ZS2231.2

## ACCO

## CLASSIC

- floodlights with accumulators offer maximum variability
- robust design suitable for working in hostile environments
- no need for a present power source
- folding stand for easy transport and storage
- IP54 coverage ensures water resistance
- 120° lighting angle
- a 3-year warranty
- usage: constructions, garages, workshops, camping, etc.

- power: 10 W
- luminous flux: 1 000 lm
- color temperature: 6 500 K
- light color: cool white
- color rendering index (CRI): Ra > 80
- voltage: 5 V DC 220–240 V AC
- IP rating: IP54
- beam angle: 120°
- dimensions: 212 × 177 × 224 mm

- battery: Li-Ion 4 400 mAh
- AKU lighting time: 3 – 10 hours
- body material: aluminum
- packaging: 1 pc, box



ZS2812

1/-/-/5

15 31 281 200

ZS2812

- power: 20 W
- luminous flux: 2 000 lm
- color temperature: 6 500 K
- light color: cool white
- color rendering index (CRI): Ra > 80
- voltage: 5 V DC 220-240 V AC
- IP rating: IP54
- beam angle: 120°
- dimensions: 266 × 220 × 273 mm

- battery: Li-Ion 6 600 mAh
- AKU lighting time: 3 – 10 hours
- body material: aluminum
- packaging: 1 pc, box



**ZS2822** 1/-/-/4  
15 31 282 200 ZS2822

- power: 30 W
- luminous flux: 3 000 lm
- color temperature: 6 500 K
- light color: cool white
- color rendering index (CRI): Ra > 80
- voltage: 5 V DC 220-240 V AC
- IP rating: IP54
- beam angle: 120°
- dimensions: 292 × 219 × 273 mm

- battery: Li-Ion 10 000 mAh
- AKU lighting time: 3 – 10 hours
- body material: aluminum
- packaging: 1 pc, box



**ZS2832** 1/-/-/2  
15 31 283 200 ZS2832

## Luminaires

## Linear Luminaires

## PROFI PLUS

### ORTO

### PROFI PLUS

- modern luminaires are made of high-quality aluminium profile
- they can be combined into different shapes
- ready for continuous installation in linear wiring
- possibility of mounted, built-in or hanging installation
- 5 years warranty
- use: office lighting, sales areas, interior spaces

- power: 8 W
- luminous flux: 800 lm
- color temperature: 4 000 K
- body material: aluminum
- color rendering index (CRI): Ra > 80
- beam angle: 110°
- type of mounting: surface/recessed
- dimensions: 151 × 151 × 58 mm
- body colour: white

- line: ORTO
- warranty period: 5 years
- UGR<: 22



**ZALL** 1/-/-/12  
15 43 081 000 ZALL

- power: 12 W
- luminous flux: 1 200 lm
- color temperature: 4 000 K
- body material: aluminum
- color rendering index (CRI): Ra > 80
- beam angle: 110°
- type of mounting: surface/recessed
- dimensions: 252 × 151 × 58 mm
- body colour: white

- line: ORTO
- warranty period: 5 years
- UGR<: 22



**ZALT**  
15 43 121 000

1/-/-8  
ZALT

- power: 15 W
- luminous flux: 1 500 lm
- color temperature: 4 000 K
- body material: aluminum
- color rendering index (CRI): Ra > 80
- beam angle: 110°
- type of mounting: surface/recessed
- dimensions: 252 × 252 × 58 mm
- body colour: white

- line: ORTO
- warranty period: 5 years
- UGR<: 22



**ZALX**  
15 43 151 000

1/-/-6  
ZALX

- power: 19 W
- luminous flux: 2 000 lm
- color temperature: 4 000 K
- body material: aluminum
- color rendering index (CRI): Ra > 80
- beam angle: 110°
- type of mounting: surface/recessed
- dimensions: 600 × 49 × 58 mm
- body colour: white

- line: ORTO
- warranty period: 5 years
- UGR<: 22



**ZAL192**  
15 43 191 000

1/-/-6  
ZAL192

- power: 38 W
- luminous flux: 4 200 lm
- color temperature: 4 000 K
- body material: aluminum
- color rendering index (CRI): Ra > 80
- beam angle: 110°
- type of mounting: surface/recessed
- dimensions: 1 200 × 49 × 58 mm
- body colour: white

- line: ORTO
- warranty period: 5 years
- UGR<: 22



**ZAL382**  
15 43 381 000

1/-/-6  
ZAL382

- product: set of ropes
- dimensions: 150 cm (cable length)
- designed for: linear luminaires
- packaging: 1 ks, box



**ZALAP**  
15 43 999 000

1/-/-100  
ZALAP

- product: set of hooks
- designed for: linear luminaires
- packaging: 1 ks, box

**ZALAR**

1/-/-/36

15 43 999 001

ZALAR

- product: power supply box
- material: metal
- designed for: linear luminaires

**ZALAS**

1/-/-/24

15 43 999 002

ZALAS

## Luminaires

## LED Panels

## PROFI PLUS

### PROXO

### PROFI PLUS

- the square or rectangular series are an effective option
- high colour rendering index models
- high efficiency and energy saving
- resistance to yellowing due to UV radiation
- 5 years warranty
- use: offices, classrooms and indoor areas

- power: 40 W
- replacement of incandescent bulb: 4× 18 W CFL
- luminous flux: 3 700 lm
- color temperature: 4 000 K
- body material: aluminum
- color rendering index (CRI): Ra > 95
- beam angle: 90°
- type of mounting: recessed
- dimensions: 595 × 595 × 10 mm

- body colour: white
- line: PROXO
- warranty period: 5 years
- UGR<: 19

**ZR1433**

1/-/-/5

15 44 104 032

ZR1433





- power: 19 W
- replacement of incandescent bulb: 2x 18 W CFL
- luminous flux: 1 800 lm
- color temperature: 4 000 K
- body material: aluminum
- color rendering index (CRI): Ra > 80
- beam angle: 120°
- type of mounting: recessed
- dimensions: 595 x 295 x 10,4 mm
- body colour: white
- line: PROXO
- warranty period: 5 years
- UGR<: 22



**ZR2212** 1/-/-/8  
15 41 181 200 ZR2212

- power: 33 W
- replacement of incandescent bulb: 4x 18 W CFL
- luminous flux: 4 360 lm
- color temperature: 4 000 K
- body material: aluminum
- color rendering index (CRI): Ra > 80
- beam angle: 120°
- type of mounting: recessed
- dimensions: 595 x 595 x 10 mm
- body colour: white
- line: PROXO
- warranty period: 5 years
- UGR<: 22



**ZB1114** 1/-/-/4  
15 44 103 320 ZB1114

- power: 33 W
- replacement of incandescent bulb: 4x 18 W CFL
- luminous flux: 4 100 lm
- color temperature: 4 000 K
- body material: aluminum
- color rendering index (CRI): Ra > 80
- beam angle: 90°
- type of mounting: recessed
- dimensions: 595 x 595 x 10 mm
- body colour: white
- line: PROXO
- warranty period: 5 years
- UGR<: 19



**ZB1124** 1/-/-/4  
15 44 103 321 ZB1124

- power: 33 W
- replacement of incandescent bulb: 2x 36 W CFL
- luminous flux: 4 360 lm
- color temperature: 4 000 K
- body material: aluminum
- color rendering index (CRI): Ra > 80
- beam angle: 120°
- type of mounting: recessed
- dimensions: 295 x 1 195 x 10 mm
- body colour: white
- line: PROXO
- warranty period: 5 years
- UGR<: 22



**ZB3114** 1/-/-/4  
15 44 203 320 ZB3114

- power: 33 W
- replacement of incandescent bulb: 2x 36 W CFL
- luminous flux: 4 100 lm
- color temperature: 4 000 K
- body material: aluminum
- color rendering index (CRI): Ra > 80
- beam angle: 90°
- type of mounting: recessed
- dimensions: 295 x 1 195 x 10 mm
- body colour: white
- line: PROXO
- warranty period: 5 years
- UGR<: 19



**ZB3124** 1/-/-/4  
15 44 203 321 ZB3124

# PIXXO

## PROFI PLUS

- square-shaped luminaire is for indoor lighting
- IP65 protection guarantees water resistance
- resistance of the light-conducting plate against yellowing due to U
- 5 years warranty
- use: offices, classrooms and indoor areas

- power: 48 W
- replacement of incandescent bulb: 4× 18 W CFL
- luminous flux: 4 800 lm
- color temperature: 4 000 K
- body material: aluminum
- color rendering index (CRI): Ra > 80
- beam angle: 120°
- type of mounting: recessed
- dimensions: 595 × 595 × 10 mm
- body colour: white
- line: PROXO
- warranty period: 5 years
- UGR<: 22



**ZR1532** 1/-/-/4  
15 44 104 820 ZR1532

# LEXXO

## PROFI PLUS

- modern energy-saving luminaires use backlit technology
- more uniform light emission and higher luminous efficiency
- outstanding performance and lighting quality – CRI > 80
- pleasant diffused light with a beam angle of 90°/120°
- 5 years warranty
- use: offices, classrooms and indoor areas

- power: 34 W
- replacement of incandescent bulb: 4× 18 W CFL
- luminous flux: 4 200 lm
- color temperature: 4 000 K
- body material: steel plate
- color rendering index (CRI): Ra > 80
- beam angle: 120°
- type of mounting: recessed
- dimensions: 595 × 595 × 30 mm
- body colour: white
- line: LEXXO
- warranty period: 5 years
- UGR<: 22



**ZR1642** 1/-/-/4  
15 44 103 428 ZR1642

- product: frame for surface installation
- dimensions: 600 × 600 × 70 mm
- material: aluminum
- designed for: Backlit panel 60 × 60
- color: white
- packaging: 1 ks, box



**ZR9036** 1/-/-/20  
15 44 100 000 ZR9036



www.emos.eu

Order Code  
Item Number

Packaging  
Type

- supported OS: #
- compatibility: #
- protocol: #
- transmission frequency: #
- control by voice assistants: #
- notifications to the mobile app: #
- other functions: #
- application languages: #
- contents of the package: #
- power: 30 W
- replacement of incandescent bulb: 4× 18 W CFL
- luminous flux: 4 000 lm
- color temperature: 4 000 K
- body material: steel plate
- color rendering index (CRI): Ra > 80
- beam angle: 90°
- type of mounting: recessed
- dimensions: 595 × 595 × 25 mm



**ZB2124** 1/-/-/4  
15 44 103 026 ZB2124



- power: 30 W
- replacement of incandescent bulb: 4× 18 W CFL
- luminous flux: 4 200 lm
- color temperature: 4 000 K
- body material: steel plate
- color rendering index (CRI): Ra > 80
- beam angle: 120°
- type of mounting: recessed
- dimensions: 595 × 595 × 25 mm
- body colour: white
- line: LEXXO
- warranty period: 5 years
- UGR<: 22



**ZB2154** 1/-/-/4  
15 44 103 027 ZB2154



## TROXO

## PROFI PLUS

- TROXO LED panels combine an attractive square design
- high luminous efficiency and energy savings
- pleasant diffused light with a very low glare index
- illuminates the room with enough intensity at an angle of 85°
- does not dazzle the surroundings with an wide beam angle
- 5 years warranty
- use: corridors, offices, classrooms, department stores

- power: 27 W
- replacement of incandescent bulb: 4× 18 W CFL
- luminous flux: 3 150 lm
- color temperature: 4 000 K
- body material: steel plate
- color rendering index (CRI): Ra > 80
- beam angle: 85°
- type of mounting: recessed
- dimensions: 595 × 595 × 23.2 mm
- body colour: white
- line: TROXO
- warranty period: 5 years
- UGR<: 16



**ZR1722** 1/-/-/4  
15 44 212 730 ZR1722



# VEXXO

## PROFI PLUS

- the square or rectangular series are an effective option
- high efficiency and energy saving
- resistance to yellowing due to UV radiation
- integrated surface mounting frame
- 5 years warranty
- use: offices, classrooms and indoor areas

- power: 33 W
- replacement of incandescent bulb: 4× 18 W CFL
- luminous flux: 4 000 lm
- color temperature: 4 000 K
- body material: aluminum
- color rendering index (CRI): Ra > 80
- beam angle: 90°
- type of mounting: surface
- dimensions: 601 × 601 × 37 mm
- body colour: white
- line: VEXXO
- warranty period: 5 years
- UGR<: 19

**ZB1524**

1/-/-/4

15 44 103 322

ZB1524

- power: 33 W
- replacement of incandescent bulb: 2× 36 W CFL
- luminous flux: 4 000 lm
- color temperature: 4 000 K
- body material: aluminum
- color rendering index (CRI): Ra > 80
- beam angle: 90°
- type of mounting: surface
- dimensions: 1 201 × 301 × 37 mm
- body colour: white
- line: VEXXO
- warranty period: 5 years
- UGR<: 19

**ZB3524**

1/-/-/4

15 44 203 322

ZB3524



# Luminaires

## LED Panels

### EXCLUSIVE

#### RIVI

#### EXCLUSIVE

- can be dimmed progressively by remote control
- ability to create and easily control groups of panels
- four preset light scenes
- 3 years warranty
- use: interiors in homes, offices or hotels

- power: 36 W
- replacement of incandescent bulb: 4× 18 W CFL
- luminous flux: 3 600 lm
- color temperature: 2 700–6 000 K
- body material: aluminum
- color rendering index (CRI): Ra > 80
- beam angle: 90°
- type of mounting: recessed
- dimensions: 595 × 595 × 10 mm
- dimming function
- body colour: white
- line: RIVI
- warranty period: 3 years
- UGR<: 19

**ZR5410**

1/-/-/4

15 44 213 670

ZR5410

- product: remote controller for ZR5410
- designed for: Exclusive LED panels

**ZR9041**

1/-/-/100

15 44 300 001

ZR9041

## Luminaires

## LED Panels

## PROFI

## MAXXO

## PROFI

- the square and rectangular for lighting office spaces
- high efficiency and energy saving
- pleasantly diffused light
- option to purchase a remote control for the ZR5410
- 3 years warranty
- use: offices, classrooms and indoor areas

- power: 36 W
- replacement of incandescent bulb: 4× 18 W CFL
- luminous flux: 4 100 lm
- color temperature: 3 000 K
- body material: aluminum
- color rendering index (CRI): Ra > 80
- beam angle: 90°
- type of mounting: recessed
- dimensions: 595 × 595 × 10 mm

- body colour: white
- line: MAXXO
- warranty period: 5 years
- UGR<: 19

**ZB1223**

1/-/-/5

15 44 103 610

ZB1223

- power: 36 W
- replacement of incandescent bulb: 4× 18 W CFL
- luminous flux: 4 320 lm
- color temperature: 4 000 K
- body material: aluminum
- color rendering index (CRI): Ra > 80
- beam angle: 120°
- type of mounting: recessed
- dimensions: 595 × 595 × 10 mm

- body colour: white
- line: MAXXO
- warranty period: 5 years
- UGR<: 22

**ZB1214**

1/-/-/5

15 44 103 628

ZB1214

- power: 36 W
- replacement of incandescent bulb: 4× 18 W CFL
- luminous flux: 4 320 lm
- color temperature: 4 000 K
- body material: aluminum
- color rendering index (CRI): Ra > 80
- beam angle: 90°
- type of mounting: recessed
- dimensions: 595 × 595 × 10 mm

- body colour: white
- line: MAXXO
- warranty period: 5 years
- UGR<: 19

**ZB1224**

1/-/-/5

15 44 103 629

ZB1224

- power: 36 W
- replacement of incandescent bulb: 2× 36 W CFL
- luminous flux: 4 320 lm
- color temperature: 4 000 K
- body material: aluminum
- color rendering index (CRI): Ra > 80
- beam angle: 120°
- type of mounting: recessed
- dimensions: 1 195 × 295 × 10 mm
- body colour: white
- line: MAXXO
- warranty period: 5 years
- UGR<: 22



**ZB3214** 1/-/-/5  
15 44 103 630 ZB3214

- power: 36 W
- replacement of incandescent bulb: 2× 36 W CFL
- luminous flux: 4 320 lm
- color temperature: 4 000 K
- body material: aluminum
- color rendering index (CRI): Ra > 80
- beam angle: 90°
- type of mounting: recessed
- dimensions: 1 195 × 295 × 10 mm
- body colour: white
- line: MAXXO
- warranty period: 5 years
- UGR<: 19



**ZB3224** 1/-/-/5  
15 44 103 631 ZB3224

## REXXO

## PROFI

- modern energy-saving luminaires use backlit technology
- more uniform light emission and higher luminous efficiency
- outstanding performance and lighting quality – CRI ≥ 80
- pleasantly diffused light
- 3 years warranty
- use: offices, classrooms and indoor areas

- power: 36 W
- replacement of incandescent bulb: 4× 18 W CFL
- luminous flux: 4 000 lm
- color temperature: 4 000 K
- body material: steel plate
- color rendering index (CRI): Ra > 80
- beam angle: 120°
- type of mounting: recessed
- dimensions: 595 × 595 × 24 mm
- body colour: white
- line: REXXO
- warranty period: 5 years
- UGR<: 22



**ZB2214** 1/-/-/6  
15 44 103 622 ZB2214

- power: 36 W
- replacement of incandescent bulb: 4× 18 W CFL
- luminous flux: 4 000 lm
- color temperature: 4 000 K
- body material: steel plate
- color rendering index (CRI): Ra > 80
- beam angle: 120°
- type of mounting: recessed
- dimensions: 595 × 595 × 24 mm
- body colour: white
- line: REXXO
- warranty period: 5 years
- UGR<: 19



**ZB2224** 1/-/-/6  
15 44 103 623 ZB2224

# Luminaires

## LED Panels

### ESSENTIAL

#### DAXXO

#### ESSENTIAL

- more uniform light emission and higher luminous efficiency
- outstanding performance and lighting quality – CRI ≥ 80
- pleasantly diffused light
- use: offices, classrooms and indoor areas

- power: 36 W
- replacement of incandescent bulb: 4× 18 W CFL
- luminous flux: 3 600 lm
- color temperature: 4 000 K
- body material: steel plate
- color rendering index (CRI): Ra > 80
- beam angle: 120°
- type of mounting: recessed
- dimensions: 595 × 595 × 30 mm

- body colour: white
- warranty period: 2 years
- UGR<: 22



8 592920 119914

**ZB2414**

1/-/-/6

15 44 103 621

ZB2414



# Luminaires

# LED Panels

## Accessories

**ZR9001**

1/-/-/100

15 42 009 001

ZR9001



8 592920 034415



product: spring set = material: metal = designed for: LED panel 60 × 60 (30) (PROXO, MAXXO) = packaging: 4 ks, packet

**ZR9002**

1/-/-/100

15 42 009 002

ZR9002



8 592920 034439



product: spring set = material: metal = designed for: LED panel 30 × 120 (PROXO, MAXXO) = packaging: 6 ks, packet

**ZR9010**

1/-/-/100

15 42 009 010

ZR9010



8 592920 034453



product: set of hooks = material: metal = designed for: LED panel 60 × 60 (30) (PROXO, MAXXO) = packaging: 4 ks, packet

**ZR9011**

1/-/-/100

15 42 009 011

ZR9011



8 592920 034477



product: set of hooks = material: metal = designed for: LED panel 30 × 120 (PROXO, MAXXO) = packaging: 6 ks, packet

**ZR9020**

1/-/-/100

15 42 009 020

ZR9020



8 592920 034491



product: set of ropes = dimensions: 5 – 145 cm (cable length) = material: metal = designed for: LED panel 60 × 60 (30) (PROXO, MAXXO) = packaging: 4 ks, packet

**ZR9021**

1/-/-/100

15 42 009 021

ZR9021





8 592920 034514





product: set of ropes = dimensions: 5 – 145 cm (cable length) = material: metal = designed for: LED panel 30 × 120 (PROXO, MAXXO) = packaging: 6 ks, packet

**ZR9034** 1/-/-/20  
15 42 009 034 ZR9034



product: frame for surface installation = dimensions: 600 × 600 × 45 mm = material: aluminum = designed for: LED panel 60 × 60 (PROXO, MAXXO) = color: white = packaging: 1 ks, box

**ZR9035** 1/-/-/15  
15 42 009 035 ZR9035



product: frame for surface installation = dimensions: 1 200 × 300 × 45 mm = material: aluminum = designed for: LED panel 30 × 120 (PROXO, MAXXO) = color: white = packaging: 1 ks, box

**ZR9036** 1/-/-/20  
15 44 100 000 ZR9036

product: frame for surface installation = dimensions: 600 × 600 × 70 mm = material: aluminum = designed for: Backlit panel 60 × 60 = color: white = packaging: 1 ks, box

**ZR9041** 1/-/-/100  
15 44 300 001 ZR9041



product: remote controller for ZR5410 = designed for: Exclusive LED panels

## Luminaires

## Drivers



- spare external drivers enabling dimming and controlling LED lights
- ensure optimal functioning, durability, energy efficiency and protection against damage to the LEDs
- 5 year warranty

**ZZ1435T** 1/-/-/50  
15 60 014 350 ZZ1435T

= voltage input: 220–240 V AC  
 = frequency: 50/60 Hz  
 = output voltage: 25–40 V DC  
 = output current: 200–350 mA  
 = power: 14 W  
 = dimensions: 97 × 46 × 31 mm  
 = type: TRIAK  
 = warranty period: 5 years



**ZZ2055T** 1/-/-/50  
15 60 020 550 ZZ2055T

= voltage input: 220–240 V AC  
 = frequency: 50/60 Hz  
 = output voltage: 25–40 V DC  
 = output current: 400–550 mA  
 = power: 20 W  
 = dimensions: 117 × 46 × 31 mm  
 = type: TRIAK  
 = warranty period: 5 years



**ZZ3070T** 1/-/-/50  
15 60 030 700 ZZ3070T





8 592920 114346

28 W 5 YEARS WARRANTY

- voltage input: 220–240 V AC
- frequency: 50/60 Hz
- output voltage: 25–40 V DC
- output current: 550–700 mA
- power: 28 W
- dimensions: 117 × 46 × 31 mm
- type: TRIAK
- warranty period: 5 years

**ZZ409BD** 1/-/-/48  
15 60 040 900 ZZ409BD

8 592920 107102

40 W 5 YEARS WARRANTY

- voltage input: 200–240 V AC
- frequency: 50/60 Hz
- output voltage: 6–42 V DC
- output current: 600–1 100 mA
- power: 40 W
- dimensions: 103 × 68 × 30 mm
- type: DALI 2.0, PUSH DIM
- warranty period: 5 years

# Luminaires

## Surface Luminaires



### EXCLUSIVE

## RIVI

**EXCLUSIVE**

- made of cast aluminium and acrylic glass
- suitable for surface mounting
- high-quality drivers LIFUD
- LGP - PMMA - pleasantly diffused light
- easy installation thanks to the installation console
- 3 years warranty
- use: interiors in homes, offices or hotels.

- power: 40 W
- luminous flux: 380–3 800 lm
- color temperature: 2 700–6 000 K
- body material: aluminum
- color rendering index (CRI): Ra > 80
- beam angle: 115°
- type of mounting: surface
- dimensions: 595 × 595 × 52 mm
- dimming function
- body colour: white
- line: RIVI
- warranty period: 3 years
- UGR<: 22

8 592920 090480

WARM WHITE MULTIPOL WHITE COOL WHITE 3 YEARS WARRANTY

**ZM5173** 1/-/-/4  
15 44 103 603 ZM5173

- power: 25 W
- luminous flux: 210–2 100 lm
- color temperature: 2 700–6 000 K
- body material: aluminum
- color rendering index (CRI): Ra > 80
- beam angle: 115°
- type of mounting: surface
- dimensions: 295 × 595 × 52 mm
- dimming function
- body colour: white
- line: RIVI
- warranty period: 3 years
- UGR<: 22





8 592920 090466

WARM WHITE MULTIPOL WHITE COOL WHITE 3 YEARS WARRANTY

**ZM5172** 1/-/-/4  
15 44 102 400 ZM5172



www.emos.eu

Order Code  
Item Number

Packaging  
Type

- power: 20 W
- luminous flux: 140-1 400 lm
- color temperature: 2 700-6 000 K
- body material: aluminum
- color rendering index (CRI): Ra > 80
- beam angle: 115°
- type of mounting: surface
- dimensions: 295 × 295 × 52 mm
- dimming function
- body colour: white
- line: RIVI
- warranty period: 3 years
- UGR<: 22



**ZM5171** 1/-/-/3  
15 44 101 800 ZM5171

## ALVI

EXCLUSIVE

- rectangle and circular shape
- included frames in 2 colours for circular models
- very economical and durable LED diodes
- fluent dimmig via remote control
- durable metal body and difussers made of PMMA material
- light colour, timer and night light settings functions
- 3 years warranty
- use: interiors in households, offices or hotels

- power: 24 W
- replacement of incandescent bulb: 120 W
- luminous flux: 80-1 920 lm
- color temperature: 2 700-6 500 K
- body material: steel plate
- color rendering index (CRI): Ra > 80
- beam angle: 115°
- type of mounting: surface
- dimensions: 360 × 58 mm in diameter
- dimming function
- body colour: white
- line: ALVI
- warranty period: 3 years



**ZM5165** 1/-/-/5  
15 39 084 002 ZM5165

- power: 36 W
- replacement of incandescent bulb: 170 W
- luminous flux: 140-2 880 lm
- color temperature: 2 700-6 500 K
- body material: steel plate
- color rendering index (CRI): Ra > 80
- beam angle: 115°
- type of mounting: surface
- dimensions: 500 × 60 mm in diameter
- dimming function
- body colour: white
- line: ALVI
- warranty period: 3 years



**ZM5166** 1/-/-/5  
15 39 084 003 ZM5166

- power: 72 W
- replacement of incandescent bulb: 270 W
- luminous flux: 250-5 000 lm
- color temperature: 2 700-6 500 K
- body material: steel plate
- color rendering index (CRI): Ra > 80
- beam angle: 115°
- type of mounting: surface
- dimensions: 884 × 583 × 64 mm
- dimming function
- body colour: silver, white
- line: ALVI
- warranty period: 3 years



**ZM5167** 1/-/-/2  
15 39 087 000 ZM5167



## ILVI

**EXCLUSIVE**

- modern luminaires of premium quality in a circular shape
- very economical and durable LEDs
- fluent dimmig via remote control
- timer function, night light and HALO effect
- 3 years warranty
- use: interiors in households, offices or hotels

- power: 30 W
- replacement of incandescent bulb: 115 W
- luminous flux: 180–1 800 lm
- color temperature: 2 700–6 500 K
- body material: plastic (PS) + steel plate
- color rendering index (CRI): Ra > 80
- beam angle: 120°
- type of mounting: surface
- dimensions: 400 × 70 mm in diameter

- dimming function
- body colour: white
- line: ILVI
- warranty period: 3 years



**ZM5168** 1/-/-/5  
15 39 094 300 ZM5168

- power: 45 W
- replacement of incandescent bulb: 160 W
- luminous flux: 270–2 700 lm
- color temperature: 2 700–6 500 K
- body material: plastic (PS) + steel plate
- color rendering index (CRI): Ra > 80
- beam angle: 120°
- type of mounting: surface
- dimensions: 500 × 70 mm in diameter

- dimming function
- body colour: white
- line: ILVI
- warranty period: 3 years



**ZM5169** 1/-/-/5  
15 39 094 450 ZM5169

## LIVI

**EXCLUSIVE**

- fluent dimming via remote control
- light colour adjustment
- timer and night light function
- 3 years warranty
- use: lighting of modern interiors, offices or hotels

- power: 30 W
- replacement of incandescent bulb: 110 W
- luminous flux: 1 800 lm
- color temperature: 2 700–6 500 K
- body material: steel plate
- color rendering index (CRI): Ra > 80
- beam angle: 115°
- type of mounting: surface
- dimensions: 400 × 85 mm in diameter

- dimming function
- body colour: white
- line: LIVI
- warranty period: 3 years



**ZM5162** 1/-/-/5  
15 39 087 301 ZM5162

- power: 45 W
- replacement of incandescent bulb: 160 W
- luminous flux: 2 700 lm
- color temperature: 2 700-6 500 K
- body material: steel plate
- color rendering index (CRI): Ra > 80
- beam angle: 115°
- type of mounting: surface
- dimensions: 500 × 90 mm in diameter

- dimming function
- body colour: white
- line: LIVI
- warranty period: 3 years



**ZM5163**  
15 39 087 451

1/-/-/5  
ZM5163

## ILVI GoSmart



- Control via remote control or mobile app
- Adjustment of light intensity and colour
- Timer and night light function
- Connection to the home network via WIFI protocol
- Compatibility with EMOS GoSmart products and TUYA devices
- Voice control with Google Assistant and Amazon Alexa

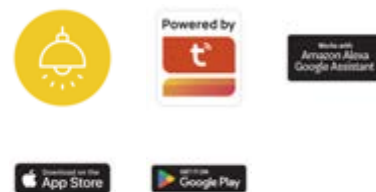

- power: 30 W
- replacement of incandescent bulb: 110 W
- luminous flux: 1 800 lm
- color temperature: 2 700-6 500 K
- body material: steel plate
- color rendering index (CRI): Ra > 80
- beam angle: 115°
- type of mounting: surface
- dimensions: 400 × 70 mm in diameter

- dimming function
- body colour: white
- line: GoSmart
- warranty period: 3 years
- supported OS: Android, iOS
- compatibility: EMOS GoSmart, TUYA, LIDL, Smartlife,
- protocol: Wi-Fi
- transmission frequency: 2.4 GHz Wi-Fi
- control by voice assistants



**ZM5191**  
15 39 087 300

1/-/-/5  
ZM5191

- power: 45 W
- replacement of incandescent bulb: 160 W
- luminous flux: 2 700 lm
- color temperature: 2 700-6 500 K
- body material: steel plate
- color rendering index (CRI): Ra > 80
- beam angle: 115°
- type of mounting: surface
- dimensions: 500 × 70 mm in diameter

- dimming function
- body colour: white
- line: GoSmart
- warranty period: 3 years
- supported OS: Android, iOS
- compatibility: EMOS GoSmart, TUYA, LIDL, Smartlife,
- protocol: Wi-Fi
- transmission frequency: 2.4 GHz Wi-Fi
- control by voice assistants



**ZM5192**  
15 39 087 450

1/-/-/5  
ZM5192

## Luminaires

## Surface Luminaires

## PROFI

## NEXXO

## PROFI

- economical surface-mount luminaires
- combination with high quality workmanship
- circular or square shape
- milky diffuser and IP44 degree of protection
- easy installation
- 3 years warranty
- use: corridors in houses, garages, utility rooms

- power: 7.6 W
- replacement of incandescent bulb: 50 W
- luminous flux: 680 lm
- color temperature: 3 000/3 500/4 000 K
- body material: steel plate
- color rendering index (CRI): Ra > 80
- beam angle: 120°
- type of mounting: surface
- dimensions: 120 × 40 mm in diameter

- body colour: white
- line: NEXXO
- warranty period: 3 years

**ZM5123**

1/-/-/8

15 39 087 070

ZM5123

- power: 7.6 W
- replacement of incandescent bulb: 50 W
- luminous flux: 680 lm
- color temperature: 4 000 K
- body material: steel plate
- color rendering index (CRI): Ra > 80
- beam angle: 120°
- type of mounting: surface
- dimensions: 120 × 40 mm in diameter

- body colour: white
- line: NEXXO
- warranty period: 3 years

**ZM5125**

1/-/-/8

15 39 085 070

ZM5125

- power: 12.5 W
- replacement of incandescent bulb: 75 W
- luminous flux: 1 100 lm
- color temperature: 3 000/3 500/4 000 K
- body material: steel plate
- color rendering index (CRI): Ra > 80
- beam angle: 120°
- type of mounting: surface
- dimensions: 170 × 42 mm in diameter

- body colour: white
- line: NEXXO
- warranty period: 3 years

**ZM5133**

1/-/-/8

15 39 087 120

ZM5133

- power: 12.5 W
- replacement of incandescent bulb: 75 W
- luminous flux: 1 100 lm
- color temperature: 4 000 K
- body material: steel plate
- color rendering index (CRI): Ra > 80
- beam angle: 120°
- type of mounting: surface
- dimensions: 170 × 42 mm in diameter

- body colour: white
- line: NEXXO
- warranty period: 3 years



**ZM5135**  
15 39 085 120

1/-/-/8  
ZM5135

- power: 21 W
- replacement of incandescent bulb: 120 W
- luminous flux: 1 900 lm
- color temperature: 3 000/3 500/4 000 K
- body material: steel plate
- color rendering index (CRI): Ra > 80
- beam angle: 120°
- type of mounting: surface
- dimensions: 225 × 42 mm in diameter

- body colour: white
- line: NEXXO
- warranty period: 3 years



**ZM5143**  
15 39 087 210

1/-/-/8  
ZM5143

- power: 21 W
- replacement of incandescent bulb: 120 W
- luminous flux: 1 900 lm
- color temperature: 4 000 K
- body material: steel plate
- color rendering index (CRI): Ra > 80
- beam angle: 120°
- type of mounting: surface
- dimensions: 225 × 42 mm in diameter

- body colour: white
- line: NEXXO
- warranty period: 3 years



**ZM5145**  
15 39 085 210

1/-/-/8  
ZM5145

- power: 28.5 W
- replacement of incandescent bulb: 160 W
- luminous flux: 2 700 lm
- color temperature: 3 000/3 500/4 000 K
- body material: steel plate
- color rendering index (CRI): Ra > 80
- beam angle: 120°
- type of mounting: surface
- dimensions: 300 × 42 mm in diameter

- body colour: white
- line: NEXXO
- warranty period: 3 years



**ZM5153**  
15 39 087 280

1/-/-/4  
ZM5153

- power: 28.5 W
- replacement of incandescent bulb: 160 W
- luminous flux: 2 700 lm
- color temperature: 4 000 K
- body material: steel plate
- color rendering index (CRI): Ra > 80
- beam angle: 120°
- type of mounting: surface
- dimensions: 300 × 42 mm in diameter

- body colour: white
- line: NEXXO
- warranty period: 3 years



**ZM5155**  
15 39 085 280

1/-/-/4  
ZM5155

- power: 12.5 W
- replacement of incandescent bulb: 75 W
- luminous flux: 1 100 lm
- color temperature: 3 000/3 500/4 000 K
- body material: steel plate
- color rendering index (CRI): Ra > 80
- beam angle: 120°
- type of mounting: surface
- dimensions: 170 × 42 mm in diameter

- body colour: brushed nickel
- line: NEXXO
- warranty period: 3 years



**ZM5233** 1/-/-/8  
15 39 087 121 ZM5233

- power: 21 W
- replacement of incandescent bulb: 120 W
- luminous flux: 1 900 lm
- color temperature: 3 000/3 500/4 000 K
- body material: steel plate
- color rendering index (CRI): Ra > 80
- beam angle: 120°
- type of mounting: surface
- dimensions: 225 × 42 mm in diameter

- body colour: brushed nickel
- line: NEXXO
- warranty period: 3 years



**ZM5243** 1/-/-/8  
15 39 087 211 ZM5243

- power: 28.5 W
- replacement of incandescent bulb: 160 W
- luminous flux: 2 700 lm
- color temperature: 3 000/3 500/4 000 K
- body material: steel plate
- color rendering index (CRI): Ra > 80
- beam angle: 120°
- type of mounting: surface
- dimensions: 300 × 42 mm in diameter

- body colour: brushed nickel
- line: NEXXO
- warranty period: 3 years



**ZM5253** 1/-/-/4  
15 39 087 281 ZM5253

- power: 12.5 W
- replacement of incandescent bulb: 75 W
- luminous flux: 1 100 lm
- color temperature: 3 000/3 500/4 000 K
- body material: steel plate
- color rendering index (CRI): Ra > 80
- beam angle: 120°
- type of mounting: surface
- dimensions: 170 × 42 mm in diameter

- body colour: black
- line: NEXXO
- warranty period: 3 years



**ZM5333** 1/-/-/8  
15 39 087 122 ZM5333

- power: 21 W
- replacement of incandescent bulb: 120 W
- luminous flux: 1 900 lm
- color temperature: 3 000/3 500/4 000 K
- body material: steel plate
- color rendering index (CRI): Ra > 80
- beam angle: 120°
- type of mounting: surface
- dimensions: 225 × 42 mm in diameter

- body colour: black
- line: NEXXO
- warranty period: 3 years



**ZM5343** 1/-/-/8  
15 39 087 212 ZM5343



- power: 28.5 W
- replacement of incandescent bulb: 160 W
- luminous flux: 2 700 lm
- color temperature: 3 000/3 500/4 000 K
- body material: steel plate
- color rendering index (CRI): Ra > 80
- beam angle: 120°
- type of mounting: surface
- dimensions: 300 × 42 mm in diameter

- body colour: black
- line: NEXXO
- warranty period: 3 years



**ZM5353** 1/-/-/4  
15 39 087 282 ZM5353

- power: 7.6 W
- replacement of incandescent bulb: 50 W
- luminous flux: 680 lm
- color temperature: 3 000/3 500/4 000 K
- body material: steel plate
- color rendering index (CRI): Ra > 80
- beam angle: 120°
- type of mounting: surface
- dimensions: 120 × 120 × 40 mm

- body colour: white
- line: NEXXO
- warranty period: 3 years



**ZM6123** 1/-/-/8  
15 39 087 071 ZM6123

- power: 7.6 W
- replacement of incandescent bulb: 50 W
- luminous flux: 680 lm
- color temperature: 4 000 K
- body material: steel plate
- color rendering index (CRI): Ra > 80
- beam angle: 120°
- type of mounting: surface
- dimensions: 120 × 120 × 40 mm

- body colour: white
- line: NEXXO
- warranty period: 3 years



**ZM6125** 1/-/-/8  
15 39 085 071 ZM6125

- power: 12.5 W
- replacement of incandescent bulb: 75 W
- luminous flux: 1 100 lm
- color temperature: 3 000/3 500/4 000 K
- body material: steel plate
- color rendering index (CRI): Ra > 80
- beam angle: 120°
- type of mounting: surface
- dimensions: 170 × 170 × 42 mm

- body colour: white
- line: NEXXO
- warranty period: 3 years



**ZM6133** 1/-/-/8  
15 39 087 123 ZM6133

- power: 12.5 W
- replacement of incandescent bulb: 75 W
- luminous flux: 1 100 lm
- color temperature: 4 000 K
- body material: steel plate
- color rendering index (CRI): Ra > 80
- beam angle: 120°
- type of mounting: surface
- dimensions: 170 × 170 × 42 mm

- body colour: white
- line: NEXXO
- warranty period: 3 years



**ZM6135** 1/-/-/8  
15 39 085 121 ZM6135

- power: 21 W
- replacement of incandescent bulb: 120 W
- luminous flux: 1 900 lm
- color temperature: 3 000/3 500/4 000 K
- body material: steel plate
- color rendering index (CRI): Ra > 80
- beam angle: 120°
- type of mounting: surface
- dimensions: 225 × 225 × 42 mm

- body colour: white
- line: NEXXO
- warranty period: 3 years



**ZM6143** 1/-/-/8  
15 39 087 213 ZM6143

- power: 21 W
- replacement of incandescent bulb: 120 W
- luminous flux: 1 900 lm
- color temperature: 4 000 K
- body material: steel plate
- color rendering index (CRI): Ra > 80
- beam angle: 120°
- type of mounting: surface
- dimensions: 225 × 225 × 42 mm

- body colour: white
- line: NEXXO
- warranty period: 3 years



**ZM6145** 1/-/-/8  
15 39 085 211 ZM6145

- power: 28.5 W
- replacement of incandescent bulb: 160 W
- luminous flux: 2 700 lm
- color temperature: 3 000/3 500/4 000 K
- body material: steel plate
- color rendering index (CRI): Ra > 80
- beam angle: 120°
- type of mounting: surface
- dimensions: 300 × 300 × 42 mm

- body colour: white
- line: NEXXO
- warranty period: 3 years



**ZM6153** 1/-/-/4  
15 39 087 283 ZM6153

- power: 28.5 W
- replacement of incandescent bulb: 160 W
- luminous flux: 2 700 lm
- color temperature: 4 000 K
- body material: steel plate
- color rendering index (CRI): Ra > 80
- beam angle: 120°
- type of mounting: surface
- dimensions: 300 × 300 × 42 mm

- body colour: white
- line: NEXXO
- warranty period: 3 years



**ZM6155** 1/-/-/4  
15 39 085 281 ZM6155

- power: 12.5 W
- replacement of incandescent bulb: 75 W
- luminous flux: 1 100 lm
- color temperature: 3 000/3 500/4 000 K
- body material: steel plate
- color rendering index (CRI): Ra > 80
- beam angle: 120°
- type of mounting: surface
- dimensions: 170 × 170 × 42 mm

- body colour: brushed nickel
- line: NEXXO
- warranty period: 3 years



**ZM6233** 1/-/-/8  
15 39 087 124 ZM6233

- power: 21 W
- replacement of incandescent bulb: 120 W
- luminous flux: 1 900 lm
- color temperature: 3 000/3 500/4 000 K
- body material: steel plate
- color rendering index (CRI): Ra > 80
- beam angle: 120°
- type of mounting: surface
- dimensions: 225 × 225 × 42 mm

- body colour: brushed nickel
- line: NEXXO
- warranty period: 3 years



**ZM6243** 1/-/-/8  
15 39 087 214 ZM6243

- power: 28.5 W
- replacement of incandescent bulb: 50 W
- luminous flux: 2 700 lm
- color temperature: 3 000/3 500/4 000 K
- body material: steel plate
- color rendering index (CRI): Ra > 80
- beam angle: 120°
- type of mounting: surface
- dimensions: 300 × 300 × 42 mm

- body colour: brushed nickel
- line: NEXXO
- warranty period: 3 years



**ZM6253** 1/-/-/4  
15 39 087 284 ZM6253

- power: 12.5 W
- replacement of incandescent bulb: 75 W
- luminous flux: 1 100 lm
- color temperature: 3 000/3 500/4 000 K
- body material: steel plate
- color rendering index (CRI): Ra > 80
- beam angle: 120°
- type of mounting: surface
- dimensions: 170 × 170 × 42 mm

- body colour: black
- line: NEXXO
- warranty period: 3 years



**ZM6333** 1/-/-/8  
15 39 087 125 ZM6333

- power: 21 W
- replacement of incandescent bulb: 120 W
- luminous flux: 1 900 lm
- color temperature: 3 000/3 500/4 000 K
- body material: steel plate
- color rendering index (CRI): Ra > 80
- beam angle: 120°
- type of mounting: surface
- dimensions: 225 × 225 × 42 mm

- body colour: black
- line: NEXXO
- warranty period: 3 years



**ZM6343** 1/-/-/8  
15 39 087 215 ZM6343

- power: 28.5 W
- replacement of incandescent bulb: 160 W
- luminous flux: 2 700 lm
- color temperature: 3 000/3 500/4 000 K
- body material: steel plate
- color rendering index (CRI): Ra > 80
- beam angle: 120°
- type of mounting: surface
- dimensions: 300 × 300 × 42 mm

- body colour: black
- line: NEXXO
- warranty period: 3 years



**ZM6353** 1/-/-/4  
15 39 087 285 ZM6353

## TIVI

## PROFI

- ceiling lamps with a light source of energy class A
- high luminous efficacy and simple design.
- IP54 enclosure ensures water resistance
- easy installation
- use: indoor and outdoor environment of premises and houses

- power: 5.2 W
- replacement of incandescent bulb: 60 W
- luminous flux: 880 lm
- color temperature: 4 000 K
- body material: steel plate
- color rendering index (CRI): Ra > 80
- beam angle: 120°
- type of mounting: surface
- dimensions: diameter 250 × 70 mm

- body colour: white
- line: TIVI
- warranty period: 5 years



**ZM3405** 1/-/-2  
15 39 085 050 ZM3405

- power: 8.6 W
- replacement of incandescent bulb: 90 W
- luminous flux: 1 440 lm
- color temperature: 4 000 K
- body material: steel plate
- color rendering index (CRI): Ra > 80
- beam angle: 120°
- type of mounting: surface
- dimensions: diameter 320 × 70 mm

- body colour: white
- line: TIVI
- warranty period: 5 years



**ZM3406** 1/-/-2  
15 39 085 080 ZM3406

- power: 11 W
- replacement of incandescent bulb: 115 W
- luminous flux: 1 840 lm
- color temperature: 4 000 K
- body material: steel plate
- color rendering index (CRI): Ra > 80
- beam angle: 120°
- type of mounting: surface
- dimensions: 380 × 70 mm in diameter

- body colour: white
- line: TIVI
- warranty period: 5 years



**ZM3407** 1/-/-2  
15 39 085 110 ZM3407

- power: 12.5 W
- replacement of incandescent bulb: 130 W
- luminous flux: 2 100 lm
- color temperature: 4 000 K
- body material: steel plate
- color rendering index (CRI): Ra > 80
- beam angle: 120°
- type of mounting: surface
- dimensions: 380 × 70 mm in diameter

- body colour: white
- line: TIVI
- warranty period: 5 years



**ZM3408** 1/-/-2  
15 39 085 122 ZM3408

# DIONI

# PROFI

- design luminaire made of high quality plastic
- possibility to change the light colour temperature and light output during installation
- energy saving
- high IP54 protection guaranteeing water resistance
- 2 colour variants
- possibility of hanging installation with optional accessories
- use: indoor and outdoor environment of all rooms and houses

- power: 15 W
- replacement of incandescent bulb: 110 W
- luminous flux: 1 725 lm
- color temperature: 3 000/4 000/5 700 K
- body material: plastic
- color rendering index (CRI): Ra > 80
- beam angle: 110°
- type of mounting: surface/hanging
- dimensions: diameter 280 × 62 mm

- body colour: white
- line: DIONI
- warranty period: 3 years

**ZM7150**

1/-/-/3

15 39 087 150

C17280-AM-TW-DP

- power: 15 W
- replacement of incandescent bulb: 110 W
- luminous flux: 1 725 lm
- color temperature: 3 000/4 000/5 700 K
- body material: plastic
- color rendering index (CRI): Ra > 80
- beam angle: 110°
- type of mounting: surface/hanging
- dimensions: diameter 280 × 62 mm

- body colour: black
- line: DIONI
- warranty period: 3 years

**ZM7153**

1/-/-/3

15 39 087 151

C17280-AM-TW-DP

- power: 18 W
- replacement of incandescent bulb: 130 W
- luminous flux: 2 160 lm
- color temperature: 3 000/4 000/5 700 K
- body material: plastic
- color rendering index (CRI): Ra > 80
- beam angle: 110°
- type of mounting: surface/hanging
- dimensions: diameter 360 × 65 mm

- body colour: white
- line: DIONI
- warranty period: 3 years

**ZM7151**

1/-/-/3

15 39 087 180

C17360-AM-TW-DP

- power: 18 W
- replacement of incandescent bulb: 110 W
- luminous flux: 2 160 lm
- color temperature: 3 000/4 000/5 700 K
- body material: plastic
- color rendering index (CRI): Ra > 80
- beam angle: 110°
- type of mounting: surface/hanging
- dimensions: diameter 360 × 65 mm

- body colour: black
- line: DIONI
- warranty period: 3 years

**ZM7154**

1/-/-/3

15 39 087 181

C17360-AM-TW-DP



- power: 32 W
- replacement of incandescent bulb: 200 W
- luminous flux: 3 520 lm
- color temperature: 3 000/4 000/5 700 K
- body material: plastic
- color rendering index (CRI): Ra > 80
- beam angle: 110°
- type of mounting: surface/hanging
- dimensions: diameter 410 × 65 mm

- body colour: white
- line: DIONI
- warranty period: 3 years



**ZM7152** 1/-/-/3  
15 39 087 320 C17410-AM-TW-DP

- power: 32 W
- replacement of incandescent bulb: 200 W
- luminous flux: 3 520 lm
- color temperature: 3 000/4 000/5 700 K
- body material: plastic
- color rendering index (CRI): Ra > 80
- beam angle: 110°
- type of mounting: surface/hanging
- dimensions: diameter 410 × 65 mm

- body colour: black
- line: DIONI
- warranty period: 3 years



**ZM7155** 1/-/-/3  
15 39 087 321 C17410-AM-TW-DP

- product: hanging kit
- material: plastic (PC) + metal
- designed for: LED luminaires
- color: white
- packaging: 1 ks, box



**ZM9000** 1/-/-/2  
15 90 900 001 ASP-C17AAA

- product: hanging kit
- material: plastic (PC) + metal
- designed for: LED luminaires
- color: black
- packaging: 1 ks, box



**ZM9001** 1/-/-/2  
15 90 900 002 ASP-C17AAA

# Luminaires

## Surface Luminaires

### CLASSIC

#### TORI

#### CLASSIC

- economical surface-mount luminaires
- combination with high quality workmanship
- circular or square shape
- milky diffuser and IP44 protection
- easy installation
- 3 years warranty
- use: corridors in houses, garages, utility rooms

- power: 15 W
- replacement of incandescent bulb: 80 W
- luminous flux: 1 500 lm
- color temperature: 3 000 K
- body material: plastic (PC)
- color rendering index (CRI): Ra > 80
- beam angle: 120°
- type of mounting: surface
- dimensions: 220 × 53 mm in diameter

- body colour: white
- line: TORI
- warranty period: 3 years

**ZM4121**

1/-/-/6

15 39 081 150

ZM4121

- power: 15 W
- replacement of incandescent bulb: 100 W
- luminous flux: 1 500 lm
- color temperature: 4 000 K
- body material: plastic (PC)
- color rendering index (CRI): Ra > 80
- beam angle: 120°
- type of mounting: surface
- dimensions: 220 × 53 mm in diameter

- body colour: white
- line: TORI
- warranty period: 3 years

**ZM4321**

1/-/-/6

15 39 082 150

ZM4321

- power: 24 W
- replacement of incandescent bulb: 145 W
- luminous flux: 2 400 lm
- color temperature: 3 000 K
- body material: plastic (PC)
- color rendering index (CRI): Ra > 80
- beam angle: 120°
- type of mounting: surface
- dimensions: 330 × 53 mm in diameter

- body colour: white
- line: TORI
- warranty period: 3 years

**ZM4122**

1/-/-/4

15 39 081 240

ZM4122

- power: 24 W
- replacement of incandescent bulb: 145 W
- luminous flux: 2 400 lm
- color temperature: 4 000 K
- body material: plastic (PC)
- color rendering index (CRI): Ra > 80
- beam angle: 120°
- type of mounting: surface
- dimensions: 330 × 53 mm in diameter

- body colour: white
- line: TORI
- warranty period: 3 years



**ZM4322** 1/-/-/4  
15 39 082 240 ZM4322

- power: 36 W
- replacement of incandescent bulb: 215 W
- luminous flux: 3 800 lm
- color temperature: 4 000 K
- body material: plastic (PC)
- color rendering index (CRI): Ra > 80
- beam angle: 120°
- type of mounting: surface
- dimensions: 400 × 53 mm

- body colour: white
- line: TORI
- warranty period: 3 years



**ZM4325** 1/-/-/4  
15 39 085 360 ZM4325

- power: 15 W
- replacement of incandescent bulb: 100 W
- luminous flux: 1 500 lm
- color temperature: 3 000 K
- body material: plastic (PC)
- color rendering index (CRI): Ra > 80
- beam angle: 120°
- type of mounting: surface
- dimensions: 220 × 220 × 53 mm

- body colour: white
- line: TORI
- warranty period: 3 years



**ZM4123** 1/-/-/10  
15 39 081 151 ZM4123

- power: 15 W
- replacement of incandescent bulb: 100 W
- luminous flux: 1 500 lm
- color temperature: 4 000 K
- body material: plastic (PC)
- color rendering index (CRI): Ra > 80
- beam angle: 120°
- type of mounting: surface
- dimensions: 220 × 220 × 53 mm

- body colour: white
- line: TORI
- warranty period: 3 years



**ZM4323** 1/-/-/10  
15 39 082 151 ZM4323

- power: 24 W
- replacement of incandescent bulb: 145 W
- luminous flux: 2 400 lm
- color temperature: 3 000 K
- body material: plastic (PC)
- color rendering index (CRI): Ra > 80
- beam angle: 120°
- type of mounting: surface
- dimensions: 330 × 330 × 53 mm

- body colour: white
- line: TORI
- warranty period: 3 years



**ZM4124** 1/-/-/4  
15 39 081 241 ZM4124

- power: 24 W
- replacement of incandescent bulb: 145 W
- luminous flux: 2 400 lm
- color temperature: 4 000 K
- body material: plastic (PC)
- color rendering index (CRI): Ra > 80
- beam angle: 120°
- type of mounting: surface
- dimensions: 330 × 330 × 53 mm

- body colour: white
- line: TORI
- warranty period: 3 years



**ZM4324** 1/-/-/4  
15 39 082 241 ZM4324

- power: 15 W
- replacement of incandescent bulb: 100 W
- luminous flux: 1 500 lm
- color temperature: 4 000 K
- body material: plastic (PC)
- color rendering index (CRI): Ra > 80
- motion sensor: MW
- beam angle: 120°
- sensor detection range: 10 m

- type of mounting: surface
- dimensions: 220 × 53 mm
- body colour: white
- line: TORI
- warranty period: 3 years



**ZM4328** 1/-/-/6  
15 39 085 150 ZM4328

- power: 24 W
- replacement of incandescent bulb: 145 W
- luminous flux: 2 400 lm
- color temperature: 4 000 K
- body material: plastic (PC)
- color rendering index (CRI): Ra > 80
- motion sensor: MW
- beam angle: 120°
- sensor detection range: 10 m

- type of mounting: surface
- dimensions: 330 × 53 mm
- body colour: white
- line: TORI
- warranty period: 3 years



**ZM4329** 1/-/-/4  
15 39 085 240 ZM4329

## CORI

## CLASSIC

- ceiling luminaires/wall-mounted LED lights
- steel luminaire body with PMMA cover
- warm or neutral light colour
- high luminous efficacy
- conservative design
- integrated design
- 3 years warranty
- use: interiors, offices spaces, hotels, homes

- power: 18 W
- replacement of incandescent bulb: 100 W
- luminous flux: 1 530 lm
- color temperature: 4 000 K
- body material: steel plate
- color rendering index (CRI): Ra > 80
- motion sensor: MW
- beam angle: 120°
- sensor detection range: 6 m

- type of mounting: surface
- dimensions: 360 × 105 mm in diameter
- body colour: white
- line: CORI
- warranty period: 3 years



**ZM3412** 1/-/-/2  
15 39 034 120 ZM3412

- power: 22 W
- replacement of incandescent bulb: 125 W
- luminous flux: 1 980 lm
- color temperature: 4 000 K
- body material: steel plate
- color rendering index (CRI): Ra > 80
- motion sensor: MW
- beam angle: 120°
- sensor detection range: 6 m
- type of mounting: surface
- dimensions: 410 × 115 mm in diameter
- body colour: white
- line: CORI
- warranty period: 3 years

**ZM3413**

1/-/-6

15 39 034 130

ZM3413

## DORI

## CLASSIC

- ceiling or wall-mounted round/square shaped luminaires
- high luminous efficacy and simple design
- the luminaires come in two shapes
- IP54 enclosure ensures water resistance
- easy installation
- use: indoor and outdoor environment of premises and houses

- power: 18 W
- replacement of incandescent bulb: 115 W
- luminous flux: 1 800 lm
- color temperature: 4 000 K
- body material: plastic (PC)
- color rendering index (CRI): Ra > 80
- beam angle: 115°
- type of mounting: surface
- dimensions: 280 × 280 × 55 mm
- body colour: white
- line: DORI
- warranty period: 2 years

**ZM4311**

1/-/-8

15 39 043 050

ZM4311

- power: 24.5 W
- replacement of incandescent bulb: 150 W
- luminous flux: 2 450 lm
- color temperature: 4 000 K
- body material: plastic (PC)
- color rendering index (CRI): Ra > 80
- beam angle: 115°
- type of mounting: surface
- dimensions: 280 × 55 mm in diameter
- body colour: white
- line: DORI
- warranty period: 2 years

**ZM4312**

1/-/-8

15 39 043 060

ZM4312

- power: 18 W
- replacement of incandescent bulb: 115 W
- luminous flux: 1 800 lm
- color temperature: 4 000 K
- body material: plastic (PC)
- color rendering index (CRI): Ra > 80
- beam angle: 115°
- type of mounting: surface
- dimensions: 280 × 280 × 55 mm
- body colour: white
- line: DORI
- warranty period: 2 years

**ZM4313**

1/-/-8

15 39 043 070

ZM4313



- power: 24.5 W
- replacement of incandescent bulb: 150 W
- luminous flux: 2 450 lm
- color temperature: 4 000 K
- body material: plastic (PC)
- color rendering index (CRI): Ra > 80
- beam angle: 115°
- type of mounting: surface
- dimensions: 280 × 280 × 55 mm

- body colour: white
- line: DORI
- warranty period: 2 years



4 000 K  
NEUTRAL  
WHITE



**ZM4314** 1/-/-8  
15 39 043 080 ZM4314



## ZURI

## CLASSIC

- made of high-quality plastic
- 2in1 - possibility to change the colour of the luminaire body
- energy saving
- IP54 protection guarantees water resistance
- 2 colour frames included
- use: indoor and outdoor environment of premises and houses

- power: 14 W
- replacement of incandescent bulb: 70 W
- luminous flux: 1 000 lm
- color temperature: 3 000 K
- body material: plastic (PC)
- color rendering index (CRI): Ra > 80
- beam angle: 120°
- type of mounting: surface
- dimensions: 215 × 80 mm in diameter

- body colour: black/white
- line: ZURI
- warranty period: 2 years



3 000 K  
WARM  
WHITE



**ZM3130** 1/-/-6  
15 39 071 140 ZM3130



- power: 14 W
- replacement of incandescent bulb: 75 W
- luminous flux: 1 100 lm
- color temperature: 4 000 K
- body material: plastic (PC)
- color rendering index (CRI): Ra > 80
- beam angle: 120°
- type of mounting: surface
- dimensions: 215 × 80 mm in diameter

- body colour: black/white
- line: ZURI
- warranty period: 2 years



4 000 K  
NEUTRAL  
WHITE



**ZM3230** 1/-/-6  
15 39 072 141 ZM3230



- power: 14 W
- replacement of incandescent bulb: 75 W
- luminous flux: 1 000 lm
- color temperature: 3 000 K
- body material: plastic (PC)
- color rendering index (CRI): Ra > 80
- motion sensor: PIR
- beam angle: 120°
- sensor detection range: 10 m

- type of mounting: surface
- dimensions: 215 × 80 mm in diameter
- body colour: black/white
- line: ZURI
- warranty period: 2 years



3 000 K  
WARM  
WHITE



**ZM3131** 1/-/-6  
15 39 071 240 ZM3131





www.emos.eu

Order Code  
Item Number

Packaging  
Type

- power: 14 W
- replacement of incandescent bulb: 75 W
- luminous flux: 1 100 lm
- color temperature: 4 000 K
- body material: plastic (PC)
- color rendering index (CRI): Ra > 80
- motion sensor: PIR
- beam angle: 120°
- sensor detection range: 10 m

- type of mounting: surface
- dimensions: 215 × 80 mm in diameter
- body colour: black/white
- line: ZURI
- warranty period: 2 years



<b>ZM3231</b>	1/-/-/6
15 39 072 240	ZM3231

## QARI

## CLASSIC

- made of high-quality plastic
- circular and oval designs
- energy savings
- IP65 enclosure ensures water resistance
- use: indoor and outdoor environment of premises and houses

- power: 20 W
- replacement of incandescent bulb: 120 W
- luminous flux: 1 900 lm
- color temperature: 4 000 K
- body material: plastic (PC)
- color rendering index (CRI): Ra > 80
- beam angle: 120°
- type of mounting: surface
- dimensions: 220 × 78 mm in diameter

- body colour: white
- line: QARI
- warranty period: 2 years



<b>ZM3010</b>	1/-/-/6
15 39 722 000	ZM3010

- power: 20 W
- replacement of incandescent bulb: 120 W
- luminous flux: 1 900 lm
- color temperature: 4 000 K
- body material: plastic (PC)
- color rendering index (CRI): Ra > 80
- beam angle: 120°
- type of mounting: surface
- dimensions: 270 × 145 × 81 mm

- body colour: white
- line: QARI
- warranty period: 2 years



<b>ZM3020</b>	1/-/-/8
15 39 722 010	ZM3020

## RORI

## CLASSIC

- Residential luminaire with night light function (2 200K)-change function via wall switch
- possibility of changing the colour temperature of the light during installation
- energy saving
- 2 colour variants - white and black
- use: home interiors

- power: 17 W
- replacement of incandescent bulb: 100 W
- luminous flux: 1 400 lm
- color temperature: 2 700/3 500/4 000 K
- body material: steel plate
- color rendering index (CRI): Ra > 90
- beam angle: 110°
- type of mounting: surface
- dimensions: diameter 310 × 75 mm

- body colour: white
- line: RORI
- warranty period: 3 years

**ZM4400**

1/-/-/3

15 39 087 170

CF63 WHITE

- power: 17 W
- replacement of incandescent bulb: 100 W
- luminous flux: 1 100 lm
- color temperature: 2 700/3 500/4 000 K
- body material: steel plate
- color rendering index (CRI): Ra > 90
- beam angle: 110°
- type of mounting: surface
- dimensions: diameter 310 × 75 mm

- body colour: black
- line: RORI
- warranty period: 3 years

**ZM4401**

1/-/-/3

15 39 087 171

CF63 BLACK

## Luminaires

## Surface Luminaires

## ESSENTIAL

## RUBIC

## ESSENTIAL

- made of high-quality plastic and custom for surface mounting
- long service life with minimal loss of luminosity
- built-in and mounted installation thanks to mounting frame
- high luminous efficiency
- integrated driver
- conservative design
- use: interior lighting in households

- power: 9 W
- replacement of incandescent bulb: 65 W
- luminous flux: 900 lm
- color temperature: 4 000 K
- body material: plastic (PC)
- color rendering index (CRI): Ra > 80
- beam angle: 120°
- type of mounting: surface
- dimensions: 120 × 42 mm in diameter

- body colour: white
- line: RUBIC
- warranty period: 2 years



4 000 K  
NEUTRAL  
WHITE



**ZM5432**

1/-/-/36

15 39 085 092

ZM5432

- power: 18 W
- replacement of incandescent bulb: 110 W
- luminous flux: 1 800 lm
- color temperature: 4 000 K
- body material: plastic (PC)
- color rendering index (CRI): Ra > 80
- beam angle: 120°
- type of mounting: surface
- dimensions: 170 × 42 mm in diameter

- body colour: white
- line: RUBIC
- warranty period: 2 years



4 000 K  
NEUTRAL  
WHITE



**ZM5442**

1/-/-/24

15 39 085 182

ZM5442

- power: 24 W
- replacement of incandescent bulb: 145 W
- luminous flux: 2 400 lm
- color temperature: 4 000 K
- body material: plastic (PC)
- color rendering index (CRI): Ra > 80
- beam angle: 120°
- type of mounting: surface
- dimensions: 220 × 42 mm in diameter

- body colour: white
- line: RUBIC
- warranty period: 2 years



4 000 K  
NEUTRAL  
WHITE



**ZM5452**

1/-/-/12

15 39 085 242

ZM5452

- power: 9 W
- replacement of incandescent bulb: 65 W
- luminous flux: 900 lm
- color temperature: 4 000 K
- body material: plastic (PC)
- color rendering index (CRI): Ra > 80
- beam angle: 120°
- type of mounting: surface
- dimensions: 120 × 120 × 42 mm

- body colour: white
- line: RUBIC
- warranty period: 2 years



4 000 K  
NEUTRAL  
WHITE



**ZM6432**  
15 39 085 093

1/-/-/36  
ZM6432

- power: 18 W
- replacement of incandescent bulb: 110 W
- luminous flux: 1 800 lm
- color temperature: 4 000 K
- body material: plastic (PC)
- color rendering index (CRI): Ra > 80
- beam angle: 120°
- type of mounting: surface
- dimensions: 170 × 170 × 42 mm

- body colour: white
- line: RUBIC
- warranty period: 2 years



4 000 K  
NEUTRAL  
WHITE



**ZM6442**  
15 39 085 183

1/-/-/24  
ZM6442

- power: 24 W
- replacement of incandescent bulb: 145 W
- luminous flux: 2 400 lm
- color temperature: 4 000 K
- body material: plastic (PC)
- color rendering index (CRI): Ra > 80
- beam angle: 120°
- type of mounting: surface
- dimensions: 220 × 220 × 42 mm

- body colour: white
- line: RUBIC
- warranty period: 2 years



4 000 K  
NEUTRAL  
WHITE



**ZM6452**  
15 39 085 243

1/-/-/12  
ZM6452

## FIONI

## ESSENTIAL

- LED luminaire with 12 W, 18 W and 24 W
- neutral white light colour
- energy saving
- easy installation
- luminous efficacy 100 lm/W

- power: 12 W
- replacement of incandescent bulb: 80 W
- luminous flux: 1 200 lm
- color temperature: 4 000 K
- body material: steel plate
- color rendering index (CRI): Ra > 80
- beam angle: 120°
- type of mounting: surface
- dimensions: 255 × 63 mm in diameter

- body colour: white
- line: FIONI
- warranty period: 2 years



4 000 K  
NEUTRAL  
WHITE



**ZM1120**  
15 39 085 123

1/-/-/4  
ZM1120



- power: 18 W
- replacement of incandescent bulb: 110 W
- luminous flux: 1 800 lm
- color temperature: 4 000 K
- body material: steel plate
- color rendering index (CRI): Ra > 80
- beam angle: 120°
- type of mounting: surface
- dimensions: 330 × 75 mm in diameter

- body colour: white
- line: FIONI
- warranty period: 2 years

4 000 K  
NEUTRAL  
WHITE**ZM1121**

1/-/-/2

15 39 085 184

ZM1121

- power: 24 W
- replacement of incandescent bulb: 150 W
- luminous flux: 2 400 lm
- color temperature: 4 000 K
- body material: steel plate
- color rendering index (CRI): Ra > 80
- beam angle: 120°
- type of mounting: surface
- dimensions: 390 × 80 mm in diameter

- body colour: white
- line: FIONI
- warranty period: 2 years

4 000 K  
NEUTRAL  
WHITE**ZM1122**

1/-/-/2

15 39 085 245

ZM1122

## FLORI

## ESSENTIAL

- quality luminaire with ceiling illumination
- in two different designs and two different sizes
- 2 colour variants - white and black
- energy saving
- easy installation
- use: home interiors

- power: 18 W
- replacement of incandescent bulb: 115 W
- luminous flux: 1 800 lm
- color temperature: 4 000 K
- body material: plastic
- color rendering index (CRI): Ra > 80
- beam angle: 110°
- type of mounting: surface
- dimensions: diameter 293 × 29 mm

- body colour: white
- line: FLORI
- warranty period: 2 years

4 000 K  
NEUTRAL  
WHITE**ZM1400**

1/-/-/6

15 39 085 186

CL8105-021

- power: 18 W
- replacement of incandescent bulb: 115 W
- luminous flux: 1 800 lm
- color temperature: 4 000 K
- body material: plastic
- color rendering index (CRI): Ra > 80
- beam angle: 110°
- type of mounting: surface
- dimensions: 293 × 293 × 29 mm

- body colour: white
- line: FLORI
- warranty period: 2 years

4 000 K  
NEUTRAL  
WHITE**ZM1402**

1/-/-/6

15 39 085 187

CL8109-031

- power: 18 W
- replacement of incandescent bulb: 115 W
- luminous flux: 1 800 lm
- color temperature: 4 000 K
- body material: plastic
- color rendering index (CRI): Ra > 80
- beam angle: 110°
- type of mounting: surface
- dimensions: diameter 293 × 29 mm

- body colour: black
- line: FLORI
- warranty period: 2 years



4 000 K  
NEUTRAL  
WHITE



**ZM1404** 1/-/-/6  
15 39 085 188 CL8106-022

- power: 18 W
- replacement of incandescent bulb: 115 W
- luminous flux: 1 800 lm
- color temperature: 4 000 K
- body material: plastic
- color rendering index (CRI): Ra > 80
- beam angle: 110°
- type of mounting: surface
- dimensions: 293 × 293 × 29 mm

- body colour: black
- line: FLORI
- warranty period: 2 years



4 000 K  
NEUTRAL  
WHITE



**ZM1406** 1/-/-/6  
15 39 085 189 CL8105-021

- power: 22 W
- replacement of incandescent bulb: 130 W
- luminous flux: 2 200 lm
- color temperature: 4 000 K
- body material: plastic
- color rendering index (CRI): Ra > 80
- beam angle: 110°
- type of mounting: surface
- dimensions: diameter 420 × 29 mm

- body colour: white
- line: FLORI
- warranty period: 2 years



4 000 K  
NEUTRAL  
WHITE



**ZM1401** 1/-/-/6  
15 39 085 220 CL8113-041

- power: 22 W
- replacement of incandescent bulb: 130 W
- luminous flux: 2 200 lm
- color temperature: 4 000 K
- body material: plastic
- color rendering index (CRI): Ra > 80
- beam angle: 110°
- type of mounting: surface
- dimensions: 420 × 420 × 29 mm

- body colour: white
- line: FLORI
- warranty period: 2 years



4 000 K  
NEUTRAL  
WHITE



**ZM1403** 1/-/-/6  
15 39 085 221 CL8105-021

- power: 22 W
- replacement of incandescent bulb: 130 W
- luminous flux: 2 200 lm
- color temperature: 4 000 K
- body material: plastic
- color rendering index (CRI): Ra > 80
- beam angle: 110°
- type of mounting: surface
- dimensions: diameter 420 × 29 mm

- body colour: black
- line: FLORI
- warranty period: 2 years



4 000 K  
NEUTRAL  
WHITE



**ZM1405** 1/-/-/6  
15 39 085 222 CL8114-042

- power: 22 W
- replacement of incandescent bulb: 130 W
- luminous flux: 2 200 lm
- color temperature: 4 000 K
- body material: plastic
- color rendering index (CRI): Ra > 80
- beam angle: 110°
- type of mounting: surface
- dimensions: 420 × 420 × 29 mm
- body colour: black
- line: FLORI
- warranty period: 2 years

**ZM1407**

1/-/-/6

15 39 085 223

CL8116-052

## Luminaires

### Surface Luminaires

### Others

**ZM9000**

1/-/-/2

15 90 900 001

ASP-C17AAA



8 592920 133118



- product: hanging kit
- material: plastic (PC) + metal
- designed for: LED luminaires
- color: white
- packaging: 1 ks, box

**ZM9001**

1/-/-/2

15 90 900 002

ASP-C17AAA



8 592920 133132



- product: hanging kit
- material: plastic (PC) + metal
- designed for: LED luminaires
- color: black
- packaging: 1 ks, box

## Luminaires

## Pendant Luminaires

## CLASSIC

## CLASSIC

- for bulbs with socket E27
- ideal in combination with filament or vintage bulbs
- attractive design in copper and brass
- possibility to install your own shade
- 3 years warranty
- use: modern interiors, bars, hotels, restaurants

- body material: pressed sheet + aluminium
- type of mounting: hanging
- dimensions: 10 × 100 cm in diameter
- body colour: copper
- warranty period: 3 years



ZC3000

1/-/10/20

15 47 300 000

ZC3000

- body material: pressed sheet + aluminium
- type of mounting: hanging
- dimensions: 10 × 100 cm in diameter
- body colour: brass
- warranty period: 3 years



ZC3100

1/-/10/20

15 47 310 000

ZC3100

## Luminaires

## Recessed Luminaires

## EXCLUSIVE

## SIMMI

## EXCLUSIVE

- elegant LED spotlights with tilt option
- have an integrated driver
- in white or with a brushed nickel surface finish
- top-quality and exclusive appearance
- 3 years warranty
- use: indoor and outdoor environment of premises and houses

- power: 5 W
- replacement of incandescent bulb: 50 W
- luminous flux: 450 lm
- color temperature: 3 000 K
- body material: plastic (PC)
- color rendering index (CRI): Ra > 80
- beam angle: 110°
- type of mounting: recessed
- dimensions: 90 × 25 mm in diameter

- mounting hole: 68 mm
- body colour: white
- line: SIMMI
- warranty period: 3 years



**ZD3121** 1/-/6/60  
15 40 115 510 ZD3121

- power: 5 W
- replacement of incandescent bulb: 50 W
- luminous flux: 450 lm
- color temperature: 4 000 K
- body material: plastic (PC)
- color rendering index (CRI): Ra > 80
- beam angle: 110°
- type of mounting: recessed
- dimensions: 90 × 25 mm in diameter

- mounting hole: 68 mm
- body colour: white
- line: SIMMI
- warranty period: 3 years



**ZD3122** 1/-/6/60  
15 40 115 570 ZD3122

- power: 5 W
- replacement of incandescent bulb: 50 W
- luminous flux: 450 lm
- color temperature: 3 000 K
- body material: aluminum
- color rendering index (CRI): Ra > 80
- beam angle: 110°
- type of mounting: recessed
- dimensions: 80 × 25 mm in diameter

- mounting hole: 68 mm
- body colour: brushed nickel
- line: SIMMI
- warranty period: 3 years



**ZD3221** 1/-/6/60  
15 40 125 510 ZD3221



- power: 5 W
- replacement of incandescent bulb: 50 W
- luminous flux: 450 lm
- color temperature: 4 000 K
- body material: aluminum
- color rendering index (CRI): Ra > 80
- beam angle: 110°
- type of mounting: recessed
- dimensions: 80 × 25 mm in diameter

- mounting hole: 68 mm
- body colour: brushed nickel
- line: SIMMI
- warranty period: 3 years



**ZD3222** 1/-/6/60  
15 40 125 570 ZD3222

# Luminaires

## Recessed Luminaires

### PROFI

## NEXXO

## PROFI

- made of cast aluminium and acrylic glass
- suitable for surface mounting
- high-quality drivers LIFUD
- LGP - PMMA - pleasantly diffused light
- easy installation thanks to the installation console
- 3 years warranty
- use: interiors in homes, offices or hotels.
- use: interior lighting in homes, offices, hotels

- power: 7 W
- replacement of incandescent bulb: 40 W
- luminous flux: 450 lm
- color temperature: 3 000 K
- body material: aluminum
- color rendering index (CRI): Ra > 82
- beam angle: 110°
- type of mounting: recessed
- dimensions: 120 × 21 mm in diameter

- mounting hole: 105 mm
- body colour: white
- line: NEXXO
- warranty period: 3 years

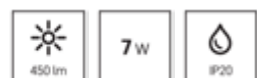

**ZD1124** 1/-/-/8  
15 40 110 613 ZD1124

- power: 7 W
- replacement of incandescent bulb: 40 W
- luminous flux: 480 lm
- color temperature: 4 000 K
- body material: aluminum
- color rendering index (CRI): Ra > 82
- beam angle: 110°
- type of mounting: recessed
- dimensions: 120 × 21 mm in diameter

- mounting hole: 105 mm
- body colour: white
- line: NEXXO
- warranty period: 3 years



**ZD1125** 1/-/-/8  
15 40 110 623 ZD1125

- power: 12.5 W
- replacement of incandescent bulb: 70 W
- luminous flux: 1 000 lm
- color temperature: 3 000 K
- body material: aluminum
- color rendering index (CRI): Ra > 82
- beam angle: 110°
- type of mounting: recessed
- dimensions: 170 × 21 mm in diameter

- mounting hole: 155 mm
- body colour: white
- line: NEXXO
- warranty period: 3 years

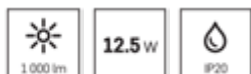

**ZD1134** 1/-/-/8  
15 40 111 214 ZD1134

- power: 12.5 W
- replacement of incandescent bulb: 70 W
- luminous flux: 1 050 lm
- color temperature: 4 000 K
- body material: aluminum
- color rendering index (CRI): Ra > 82
- beam angle: 110°
- type of mounting: recessed
- dimensions: 170 × 21 mm in diameter

- mounting hole: 155 mm
- body colour: white
- line: NEXXO
- warranty period: 3 years



**ZD1135** 1/-/-/8  
15 40 111 224 ZD1135

- power: 18 W
- replacement of incandescent bulb: 100 W
- luminous flux: 1 500 lm
- color temperature: 3 000 K
- body material: aluminum
- color rendering index (CRI): Ra > 82
- beam angle: 110°
- type of mounting: recessed
- dimensions: 225 × 21 mm in diameter

- mounting hole: 205 mm
- body colour: white
- line: NEXXO
- warranty period: 3 years



**ZD1144** 1/-/-/8  
15 40 111 813 ZD1144

- power: 18 W
- replacement of incandescent bulb: 100 W
- luminous flux: 1 600 lm
- color temperature: 4 000 K
- body material: aluminum
- color rendering index (CRI): Ra > 82
- beam angle: 110°
- type of mounting: recessed
- dimensions: 225 × 21 mm in diameter

- mounting hole: 205 mm
- body colour: white
- line: NEXXO
- warranty period: 3 years



**ZD1145** 1/-/-/8  
15 40 111 823 ZD1145

- power: 25 W
- replacement of incandescent bulb: 125 W
- luminous flux: 2 000 lm
- color temperature: 3 000 K
- body material: aluminum
- color rendering index (CRI): Ra > 82
- beam angle: 110°
- type of mounting: recessed
- dimensions: 300 × 21 mm in diameter

- mounting hole: 280 mm
- body colour: white
- line: NEXXO
- warranty period: 3 years



**ZD1154** 1/-/-/4  
15 40 112 413 ZD1154

- power: 25 W
- replacement of incandescent bulb: 125 W
- luminous flux: 2 100 lm
- color temperature: 4 000 K
- body material: aluminum
- color rendering index (CRI): Ra > 82
- beam angle: 110°
- type of mounting: recessed
- dimensions: 300 × 21 mm in diameter

- mounting hole: 280 mm
- body colour: white
- line: NEXXO
- warranty period: 3 years



**ZD1155**  
15 40 112 423

1/-/-4  
ZD1155

- power: 7 W
- replacement of incandescent bulb: 40 W
- luminous flux: 480 lm
- color temperature: 3 000/3 500/4 000 K
- body material: aluminum
- color rendering index (CRI): Ra > 82
- beam angle: 110°
- type of mounting: recessed
- dimensions: 120 × 21 mm in diameter

- mounting hole: 105 mm
- body colour: brushed nickel
- line: NEXXO
- warranty period: 3 years



**ZD1223**  
15 40 130 670

1/-/-8  
ZD1223

- power: 12.5 W
- replacement of incandescent bulb: 70 W
- luminous flux: 1 050 lm
- color temperature: 3 000/3 500/4 000 K
- body material: aluminum
- color rendering index (CRI): Ra > 82
- beam angle: 110°
- type of mounting: recessed
- dimensions: 170 × 21 mm in diameter

- mounting hole: 155 mm
- body colour: brushed nickel
- line: NEXXO
- warranty period: 3 years



**ZD1233**  
15 40 131 270

1/-/-8  
ZD1233

- power: 18 W
- replacement of incandescent bulb: 100 W
- luminous flux: 1 600 lm
- color temperature: 3 000/3 500/4 000 K
- body material: aluminum
- color rendering index (CRI): Ra > 82
- beam angle: 110°
- type of mounting: recessed
- dimensions: 225 × 21 mm in diameter

- mounting hole: 205 mm
- body colour: brushed nickel
- line: NEXXO
- warranty period: 3 years



**ZD1243**  
15 40 131 870

1/-/-8  
ZD1243

- power: 7 W
- replacement of incandescent bulb: 40 W
- luminous flux: 480 lm
- color temperature: 3 000/3 500/4 000 K
- body material: aluminum
- color rendering index (CRI): Ra > 82
- beam angle: 110°
- type of mounting: recessed
- dimensions: 120 × 21 mm in diameter

- mounting hole: 105 mm
- body colour: black
- line: NEXXO
- warranty period: 3 years



**ZD1323**  
15 40 140 670

1/-/-8  
ZD1323

- power: 12.5 W
- replacement of incandescent bulb: 70 W
- luminous flux: 1 050 lm
- color temperature: 3 000/3 500/4 000 K
- body material: aluminum
- color rendering index (CRI): Ra > 82
- beam angle: 110°
- type of mounting: recessed
- dimensions: 170 × 21 mm in diameter

- mounting hole: 155 mm
- body colour: black
- line: NEXXO
- warranty period: 3 years



**ZD1333** 1/-/-/8  
15 40 141 270 ZD1333

- power: 18 W
- replacement of incandescent bulb: 100 W
- luminous flux: 1 600 lm
- color temperature: 3 000/3 500/4 000 K
- body material: aluminum
- color rendering index (CRI): Ra > 82
- beam angle: 110°
- type of mounting: recessed
- dimensions: 225 × 21 mm in diameter

- mounting hole: 205 mm
- body colour: black
- line: NEXXO
- warranty period: 3 years



**ZD1343** 1/-/-/8  
15 40 141 870 ZD1343

- power: 7 W
- replacement of incandescent bulb: 40 W
- luminous flux: 450 lm
- color temperature: 3 000 K
- body material: aluminum
- color rendering index (CRI): Ra > 82
- beam angle: 110°
- type of mounting: recessed
- dimensions: 120 × 120 × 21 mm

- mounting hole: 105 × 105 mm
- body colour: white
- line: NEXXO
- warranty period: 3 years



**ZD2124** 1/-/-/8  
15 40 210 612 ZD2124

- power: 7 W
- replacement of incandescent bulb: 40 W
- luminous flux: 480 lm
- color temperature: 4 000 K
- body material: aluminum
- color rendering index (CRI): Ra > 82
- beam angle: 110°
- type of mounting: recessed
- dimensions: 120 × 120 × 21 mm

- mounting hole: 105 × 105 mm
- body colour: white
- line: NEXXO
- warranty period: 3 years

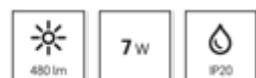

**ZD2125** 1/-/-/8  
15 40 210 622 ZD2125

- power: 12.5 W
- replacement of incandescent bulb: 70 W
- luminous flux: 1 000 lm
- color temperature: 3 000 K
- body material: aluminum
- color rendering index (CRI): Ra > 82
- beam angle: 110°
- type of mounting: recessed
- dimensions: 170 × 170 × 21 mm

- mounting hole: 155 × 155 mm
- body colour: white
- line: NEXXO
- warranty period: 3 years



**ZD2134** 1/-/-/8  
15 40 211 213 ZD2134

- power: 12.5 W
- replacement of incandescent bulb: 70 W
- luminous flux: 1 050 lm
- color temperature: 4 000 K
- body material: aluminum
- color rendering index (CRI): Ra > 82
- beam angle: 110°
- type of mounting: recessed
- dimensions: 170 × 170 × 21 mm

- mounting hole: 155 × 155 mm
- body colour: white
- line: NEXXO
- warranty period: 3 years

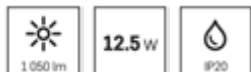

**ZD2135** 1/-/-/8  
15 40 211 223 ZD2135

- power: 18 W
- replacement of incandescent bulb: 100 W
- luminous flux: 1 500 lm
- color temperature: 3 000 K
- body material: aluminum
- color rendering index (CRI): Ra > 82
- beam angle: 110°
- type of mounting: recessed
- dimensions: 225 × 225 × 21 mm

- mounting hole: 205 × 205 mm
- body colour: white
- line: NEXXO
- warranty period: 3 years



**ZD2144** 1/-/-/8  
15 40 211 813 ZD2144

- power: 18 W
- replacement of incandescent bulb: 100 W
- luminous flux: 1 600 lm
- color temperature: 4 000 K
- body material: aluminum
- color rendering index (CRI): Ra > 82
- beam angle: 110°
- type of mounting: recessed
- dimensions: 225 × 225 × 21 mm

- mounting hole: 205 × 205 mm
- body colour: white
- line: NEXXO
- warranty period: 3 years



**ZD2145** 1/-/-/8  
15 40 211 823 ZD2145

- power: 25 W
- replacement of incandescent bulb: 125 W
- luminous flux: 2 000 lm
- color temperature: 3 000 K
- body material: aluminum
- color rendering index (CRI): Ra > 82
- beam angle: 110°
- type of mounting: recessed
- dimensions: 300 × 300 × 21 mm

- mounting hole: 280 × 280 mm
- body colour: white
- line: NEXXO
- warranty period: 3 years



**ZD2154** 1/-/-/4  
15 40 212 413 ZD2154

- power: 25 W
- replacement of incandescent bulb: 125 W
- luminous flux: 2 100 lm
- color temperature: 4 000 K
- body material: aluminum
- color rendering index (CRI): Ra > 82
- beam angle: 110°
- type of mounting: recessed
- dimensions: 300 × 300 × 21 mm

- mounting hole: 280 × 280 mm
- body colour: white
- line: NEXXO
- warranty period: 3 years



**ZD2155** 1/-/-/4  
15 40 212 424 ZD2155



- power: 7 W
- replacement of incandescent bulb: 40 W
- luminous flux: 480 lm
- color temperature: 3 000/3 500/4 000 K
- body material: aluminum
- color rendering index (CRI): Ra > 82
- beam angle: 110°
- type of mounting: recessed
- dimensions: 120 × 120 × 21 mm

- mounting hole: 105 × 105 mm
- body colour: brushed nickel
- line: NEXXO
- warranty period: 3 years



**ZD2223** 1/-/-/8  
15 40 230 670 ZD2223

- power: 12.5 W
- replacement of incandescent bulb: 70 W
- luminous flux: 1 050 lm
- color temperature: 3 000/3 500/4 000 K
- body material: aluminum
- color rendering index (CRI): Ra > 82
- beam angle: 110°
- type of mounting: recessed
- dimensions: 170 × 170 × 21 mm

- mounting hole: 155 × 155 mm
- body colour: brushed nickel
- line: NEXXO
- warranty period: 3 years



**ZD2233** 1/-/-/8  
15 40 231 270 ZD2233

- power: 18 W
- replacement of incandescent bulb: 100 W
- luminous flux: 1 600 lm
- color temperature: 3 000/3 500/4 000 K
- body material: aluminum
- color rendering index (CRI): Ra > 82
- beam angle: 110°
- type of mounting: recessed
- dimensions: 225 × 225 × 21 mm

- mounting hole: 205 × 205 mm
- body colour: brushed nickel
- line: NEXXO
- warranty period: 3 years



**ZD2243** 1/-/-/8  
15 40 231 870 ZD2243

- power: 7 W
- replacement of incandescent bulb: 40 W
- luminous flux: 480 lm
- color temperature: 3 000/3 500/4 000 K
- body material: aluminum
- color rendering index (CRI): Ra > 82
- beam angle: 110°
- type of mounting: recessed
- dimensions: 120 × 120 × 21 mm

- mounting hole: 105 × 105 mm
- body colour: black
- line: NEXXO
- warranty period: 3 years



**ZD2323** 1/-/-/8  
15 40 240 670 ZD2323

- power: 12.5 W
- replacement of incandescent bulb: 70 W
- luminous flux: 1 050 lm
- color temperature: 3 000/3 500/4 000 K
- body material: aluminum
- color rendering index (CRI): Ra > 82
- beam angle: 110°
- type of mounting: recessed
- dimensions: 170 × 170 × 21 mm

- mounting hole: 155 × 155 mm
- body colour: black
- line: NEXXO
- warranty period: 3 years



**ZD2333** 1/-/-/8  
15 40 241 270 ZD2333

- power: 18 W
- replacement of incandescent bulb: 100 W
- luminous flux: 1 600 lm
- color temperature: 3 000/3 500/4 000 K
- body material: aluminum
- color rendering index (CRI): Ra > 82
- beam angle: 110°
- type of mounting: recessed
- dimensions: 225 × 225 × 21 mm

- mounting hole: 205 × 205 mm
- body colour: black
- line: NEXXO
- warranty period: 3 years



**ZD2343** 1/-/-/8  
15 40 241 870 ZD2343

## VIXXO

## PROFI

- thin attractive frameless LED luminaires
- high quality aluminium alloy with white exterior finish
- allow easy horizontal and vertical installation
- IP65 enclosure ensures water resistance
- 3 years warranty
- use: bathrooms and toilets, kitchen

- power: 6 W
- replacement of incandescent bulb: 42 W
- luminous flux: 500 lm
- color temperature: 4 000 K
- body material: aluminum
- color rendering index (CRI): Ra > 80
- beam angle: 120°
- type of mounting: recessed
- dimensions: 70 × 20 mm in diameter

- mounting hole: 55 mm
- body colour: white
- line: VIXXO
- warranty period: 3 years



**ZV1112** 1/-/4/20  
15 40 110 621 ZV1112

- power: 7,5 W
- replacement of incandescent bulb: 50 W
- luminous flux: 650 lm
- color temperature: 4 000 K
- body material: aluminum
- color rendering index (CRI): Ra > 80
- beam angle: 120°
- type of mounting: recessed
- dimensions: 100 × 20 mm in diameter

- mounting hole: 80 mm
- body colour: white
- line: VIXXO
- warranty period: 3 years



**ZV1122** 1/-/4/20  
15 40 110 820 ZV1122

- power: 10 W
- replacement of incandescent bulb: 65 W
- luminous flux: 900 lm
- color temperature: 4 000 K
- body material: aluminum
- color rendering index (CRI): Ra > 80
- beam angle: 120°
- type of mounting: recessed
- dimensions: 125 × 20 mm in diameter

- mounting hole: 105 mm
- body colour: white
- line: VIXXO
- warranty period: 3 years



**ZV1132** 1/-/4/16  
15 40 111 120 ZV1132

- power: 13.5 W
- replacement of incandescent bulb: 85 W
- luminous flux: 1 250 lm
- color temperature: 4 000 K
- body material: aluminum
- color rendering index (CRI): Ra > 80
- beam angle: 120°
- type of mounting: recessed
- dimensions: 155 × 20 mm in diameter

- mounting hole: 135 mm
- body colour: white
- line: VIXXO
- warranty period: 3 years



**ZV1142** 1/-/-/10  
15 40 111 520 ZV1142

- power: 19 W
- replacement of incandescent bulb: 110 W
- luminous flux: 1 700 lm
- color temperature: 4 000 K
- body material: aluminum
- color rendering index (CRI): Ra > 80
- beam angle: 120°
- type of mounting: recessed
- dimensions: 185 × 20 mm in diameter

- mounting hole: 165 mm
- body colour: white
- line: VIXXO
- warranty period: 3 years



**ZV1152** 1/-/-/12  
15 40 112 220 ZV1152

- power: 6 W
- replacement of incandescent bulb: 42 W
- luminous flux: 500 lm
- color temperature: 4 000 K
- body material: aluminum
- color rendering index (CRI): Ra > 80
- beam angle: 120°
- type of mounting: recessed
- dimensions: 75 × 75 × 20 mm

- mounting hole: 55 × 55 mm
- body colour: white
- line: VIXXO
- warranty period: 3 years



**ZV2112** 1/-/4/20  
15 40 210 621 ZV2112

- power: 7.5 W
- replacement of incandescent bulb: 50 W
- luminous flux: 650 lm
- color temperature: 4 000 K
- body material: aluminum
- color rendering index (CRI): Ra > 80
- beam angle: 120°
- type of mounting: recessed
- dimensions: 100 × 100 × 20 mm

- mounting hole: 80 × 80 mm
- body colour: white
- line: VIXXO
- warranty period: 3 years



**ZV2122** 1/-/4/20  
15 40 210 820 ZV2122

- power: 10 W
- replacement of incandescent bulb: 65 W
- luminous flux: 900 lm
- color temperature: 4 000 K
- body material: aluminum
- color rendering index (CRI): Ra > 80
- beam angle: 120°
- type of mounting: recessed
- dimensions: 125 × 125 × 20 mm

- mounting hole: 105 × 105 mm
- body colour: white
- line: VIXXO
- warranty period: 3 years



**ZV2132** 1/-/4/16  
15 40 211 120 ZV2132

- power: 13.5 W
- replacement of incandescent bulb: 85 W
- luminous flux: 1 250 lm
- color temperature: 4 000 K
- body material: aluminum
- color rendering index (CRI): Ra > 80
- beam angle: 120°
- type of mounting: recessed
- dimensions: 155 × 155 × 20 mm

- mounting hole: 135 × 135 mm
- body colour: white
- line: VIXXO
- warranty period: 3 years



**ZV2142** 1/-/-/10  
15 40 211 520 ZV2142

- power: 19 W
- replacement of incandescent bulb: 110 W
- luminous flux: 1 700 lm
- color temperature: 4 000 K
- body material: aluminum
- color rendering index (CRI): Ra > 80
- beam angle: 120°
- type of mounting: recessed
- dimensions: 185 × 185 × 20 mm

- mounting hole: 165 × 165 mm
- body colour: white
- line: VIXXO
- warranty period: 3 years



**ZV2152** 1/-/-/12  
15 40 212 220 ZV2152

## GERI

## PROFI

- can be tilted up to 90 degrees
- two colour variants
- easy installation
- 3 years warranty
- use: illumination of walls, shelves, paintings

- power: 6.5 W
- replacement of incandescent bulb: 40 W
- luminous flux: 780 lm
- color temperature: 2 700/4 000/6 500 K
- body material: aluminum
- color rendering index (CRI): Ra > 80
- beam angle: 36°
- type of mounting: recessed
- dimensions: diameter 105 × 40 mm

- mounting hole: 87 mm
- dimming function: yes – Triac
- body colour: white
- line: GERI
- warranty period: 3 years



**ZV1160** 1/-/-/20  
15 40 116 500 GIMBALL

- power: 6.5 W
- replacement of incandescent bulb: 40 W
- luminous flux: 700 lm
- color temperature: 2 700/4 000/6 500 K
- body material: aluminum
- color rendering index (CRI): Ra > 80
- beam angle: 36°
- type of mounting: recessed
- dimensions: diameter 105 × 40 mm

- mounting hole: 87 mm
- dimming function: yes – Triac
- body colour: black
- line: GERI
- warranty period: 3 years



**ZV1161** 1/-/-/20  
15 40 146 500 GIMBALL

# Luminaires

## Recessed Luminaires

### ESSENTIAL

## RUBIC

## ESSENTIAL

- white are made of high-quality plastic
- designed to be recessed into plasterboard
- long service life with minimal loss of luminosity
- high luminous efficiency
- conservative design
- integrated driver
- use: interior lighting in households

- power: 9 W
- replacement of incandescent bulb: 65 W
- luminous flux: 900 lm
- color temperature: 4 000 K
- body material: plastic (PC)
- color rendering index (CRI): Ra > 80
- beam angle: 120°
- type of mounting: recessed
- dimensions: 120 × 26 mm in diameter

- mounting hole: 90–110 mm
- body colour: white
- line: RUBIC
- warranty period: 2 years



4 000 K  
NEUTRAL  
WHITE



**ZD1432** 1/-/-/48  
15 39 085 090 ZD1432

- power: 18 W
- replacement of incandescent bulb: 110 W
- luminous flux: 1 800 lm
- color temperature: 4 000 K
- body material: plastic (PC)
- color rendering index (CRI): Ra > 80
- beam angle: 120°
- type of mounting: recessed
- dimensions: 170 × 26 mm in diameter

- mounting hole: 140–160 mm
- body colour: white
- line: RUBIC
- warranty period: 2 years



4 000 K  
NEUTRAL  
WHITE



**ZD1442** 1/-/-/32  
15 39 085 180 ZD1442

- power: 24 W
- replacement of incandescent bulb: 145 W
- luminous flux: 2 400 lm
- color temperature: 4 000 K
- body material: plastic (PC)
- color rendering index (CRI): Ra > 80
- beam angle: 120°
- type of mounting: recessed
- dimensions: 220 × 26 mm in diameter

- mounting hole: 190–210 mm
- body colour: white
- line: RUBIC
- warranty period: 2 years



4 000 K  
NEUTRAL  
WHITE



**ZD1452** 1/-/-/16  
15 39 085 244 ZD1452





www.emos.eu

Order Code  
Item Number

Packaging  
Type

- power: 9 W
- replacement of incandescent bulb: 65 W
- luminous flux: 900 lm
- color temperature: 4 000 K
- body material: plastic (PC)
- color rendering index (CRI): Ra > 80
- beam angle: 120°
- type of mounting: recessed
- dimensions: 120 × 120 × 26 mm

- mounting hole: 90–110 mm
- body colour: white
- line: RUBIC
- warranty period: 2 years



4 000 K  
NEUTRAL  
WHITE



**ZD2432**  
15 39 085 091

1/-/-/45  
ZD2432

- power: 18 W
- replacement of incandescent bulb: 110 W
- luminous flux: 1 800 lm
- color temperature: 4 000 K
- body material: plastic (PC)
- color rendering index (CRI): Ra > 80
- beam angle: 120°
- type of mounting: recessed
- dimensions: 170 × 170 × 26 mm

- mounting hole: 140–160 mm
- body colour: white
- line: RUBIC
- warranty period: 2 years



4 000 K  
NEUTRAL  
WHITE



**ZD2442**  
15 39 085 181

1/-/-/32  
ZD2442

- power: 24 W
- replacement of incandescent bulb: 145 W
- luminous flux: 2 400 lm
- color temperature: 4 000 K
- body material: plastic (PC)
- color rendering index (CRI): Ra > 80
- beam angle: 120°
- type of mounting: recessed
- dimensions: 220 × 220 × 26 mm

- mounting hole: 190–210 mm
- body colour: white
- line: RUBIC
- warranty period: 2 years



4 000 K  
NEUTRAL  
WHITE



**ZD2452**  
15 39 085 241

1/-/-/16  
ZD2452

# Luminaires

## Emergency Luminaires

### PROFI

#### CESSI

#### PROFI

- emergency luminaires are used in case of power failure
- ensure safe egress from rooms during a power outage
- sufficient backup power for 3 hours during a power outage
- test button and LED indicator for testing functionality
- 4 years warranty
- use: industrial buildings, garages, hallways, offices

- type of emergency operation test: manual button
- light color: cool white
- IP rating: IP20
- body material: plastic (PC)
- power voltage: 220–240 V AC
- input power: 3 W max.
- dimensions: 315 × 223 × 45 mm
- luminous flux: 30 lm
- color temperature: 5 000 K
- mounting type: attached
- warranty period: 4 years
- backup time: 3 h
- battery type: Ni-Cd
- battery capacity: 900 mAh
- type of emergency light operation: maintained/non-

**ZN1210**

1/-/-/6

15 48 121 000

ZN1210

- body material: plastic (PC)
- dimensions: 386 × 80 × 74 mm
- mounting type: recessed
- warranty period: 4 years

**ZN1211**

1/-/-/8

15 48 121 100

ZN1211

# NESSI

## PROFI

- emergency luminaires are used in case of power failure
- ensure safe egress from rooms during a power outage
- sufficient backup power for 3 hours during a power outage
- test button and LED indicator for testing functionality
- 4 years warranty
- use: industrial buildings, garages, hallways, offices

- type of emergency operation test: manual button
- light color: cool white
- IP rating: IP65
- body material: plastic (ABS)
- power voltage: 220-240 V AC
- input power: 3 W
- dimensions: 351 × 111 × 63 mm
- luminous flux: 150 lm
- color temperature: 6 500 K
- mounting type: attached
- warranty period: 4 years
- backup time: 3 h
- battery type: LiFePo4
- battery capacity: 1 500 mAh
- type of emergency light operation: maintained/non-



**ZN1110** 1/-/-/10  
15 48 111 000 ZN1110

- body material: steel plate
- dimensions: 387 × 147 × 30 mm
- mounting type: recessed
- warranty period: 4 years



**ZN1111** 1/-/-/10  
15 48 111 100 ZN1111

- IP rating: IP65
- body material: plastic (PC)
- dimensions: 350 × 113 × 192 mm
- warranty period: 4 years



**ZN1112** 1/-/-/10  
15 48 111 200 ZN1112

# ORSU

## PROFÍ

- emergency luminaires are used in case of power failure
- ensure safe egress from rooms during a power outage
- sufficient backup power for 3 hours during a power outage
- test button and LED indicator for testing functionality
- 4 years warranty
- use: industrial and warehouse buildings, corridors, offices

- |                                                   |                                                     |
|---------------------------------------------------|-----------------------------------------------------|
| ▪ type of emergency operation test: manual button | ▪ mounting type: recessed                           |
| ▪ light color: cool white                         | ▪ warranty period: 4 years                          |
| ▪ IP rating: IP20                                 | ▪ backup time: 3 h                                  |
| ▪ body material: plastic (PC)                     | ▪ battery type: LiFePo4                             |
| ▪ power voltage: 220-240 V AC                     | ▪ battery capacity: 1 500 mAh                       |
| ▪ input power: 3 W                                | ▪ type of emergency light operation: non-maintained |
| ▪ dimensions: 140 × 55 mm in diameter             |                                                     |
| ▪ luminous flux: 240 lm                           |                                                     |
| ▪ color temperature: 6 500 K                      |                                                     |



**ZN1310** 1/-/-/12  
15 48 131 000 ZN1310

- body material: plastic (PC)
- dimensions: 140 × 55 mm in diameter
- mounting type: attached
- warranty period: 4 years



**ZN1311** 1/-/-/12  
15 48 131 100 ZN1311

# Luminaires

## Emergency Luminaires

### Emergency conversion kit

- type of emergency operation test: manual button
- IP rating: IP20
- body material: plastic (PC)
- power voltage: 220–240 V AC
- input power: 6 W max.
- dimensions: 212 × 73 × 28 mm
- warranty period: 3 years
- backup time: 1 h
- battery type: LiFePo4
- battery capacity: 1 500 mAh



8 592920 086001

**ZR9310**

15 48 931 000

1/-/-/20

ZR9310



# Luminaires

## Orientation Luminaires

### CLASSIC

## AMAL

## CLASSIC

- orientation luminaires in brushed aluminium
- designed for recessed mounting
- the aluminium body and glass milk diffuse
- a superior service life
- minimal power consumption
- IP65 protection guarantees water resistance
- in neutral or warm white
- use: stairs, exterior facades, walls

- colour: stainless steel
- light color: warm white
- IP rating: IP65
- material of the diffuser: glass
- body material: aluminum
- mounting hole: 113 × 43 × 65 mm
- voltage: 220–240 V
- packaging: 1 pc, box
- power: 1.5 W

- dimensions: 123 × 53 × 61 mm
- luminous flux: 55 lm
- color temperature: 3 000 K
- source of light: LED
- lifetime: 30 000 hours



**ZC0108** 1/-/-/24  
15 45 000 080 ZC0108

- colour: stainless steel
- light color: neutral white
- IP rating: IP65
- material of the diffuser: glass
- body material: aluminum
- mounting hole: 113 × 43 × 65 mm
- voltage: 220–240 V
- packaging: 1 pc, box
- power: 1.5 W

- dimensions: 123 × 53 × 61 mm
- luminous flux: 55 lm
- color temperature: 4 000 K
- source of light: LED
- lifetime: 30 000 hours



**ZC0110** 1/-/-/24  
15 45 000 100 ZC0110

- colour: stainless steel
- light color: warm white
- IP rating: IP65
- material of the diffuser: glass
- body material: aluminum
- mounting hole: 75 × 70 mm
- voltage: 220–240 V
- packaging: 1 pc, box
- power: 1.5 W

- dimensions: 80 × 80 × 61 mm
- luminous flux: 75 lm
- color temperature: 3 000 K
- source of light: LED
- lifetime: 30 000 hours



**ZC0109** 1/-/-/24  
15 45 000 090 ZC0109



www.emos.eu

Order Code  
Item Number

Packaging  
Type

- colour: stainless steel
- light color: neutral white
- IP rating: IP65
- material of the diffuser: glass
- body material: aluminum
- mounting hole: 75 × 70 mm
- voltage: 220–240 V
- packaging: 1 pc, box
- power: 2 W

- dimensions: 80 × 80 × 61 mm
- luminous flux: 70 lm
- color temperature: 4 000 K
- source of light: LED
- lifetime: 30 000 hours



4 000 K  
NEUTRAL  
WHITE



**ZC0111** 1/-/-/24  
15 45 000 110 ZC0111

## DIRAL

## CLASSIC

- in several shapes and sizes
- designed for recessed mounting
- the aluminium body and glass milk diffuser
- a superior service life
- IP65 protection guarantees water resistance
- for indoor and outdoor areas
- use: stairs, exteriors facades, walls

- colour: grey
- light color: warm white
- IP rating: IP65
- material of the diffuser: glass
- body material: aluminum
- mounting hole: 80 × 75 mm
- voltage: 220–240 V
- packaging: 1 pc, box
- power: 1 W

- dimensions: 90 × 90 × 71 mm
- luminous flux: 25 lm
- color temperature: 3 000 K
- source of light: LED
- lifetime: 30 000 hours



3 000 K  
WARM  
WHITE



**ZC0105** 1/-/-/16  
15 45 000 050 ZC0105

- colour: grey
- light color: warm white
- IP rating: IP65
- material of the diffuser: glass
- body material: aluminum
- mounting hole: 125 × 58 mm
- voltage: 220–240 V
- packaging: 1 pc, box
- power: 3 W

- dimensions: 140 × 70 × 71 mm
- luminous flux: 90 lm
- color temperature: 3 000 K
- source of light: LED
- lifetime: 30 000 hours



3 000 K  
WARM  
WHITE



**ZC0106** 1/-/-/16  
15 45 000 060 ZC0106

# DIRBI

# CLASSIC

- orientation luminaires for surface-mounted installation
- excellent price/quality ratio
- the ABS plastic body and polycarbonate diffuser
- a long service life
- minimal power consumption
- for indoor and outdoor areas
- IP65 protection guarantees water resistance
- use: stairs, exterior facades, walls

- colour: dark grey
- light color: neutral white
- IP rating: IP65
- material of the diffuser: polycarbonate
- body material: ABS
- voltage: 220–240 V
- packaging: 1 pc, box
- power: 3 W
- dimensions: 120 × 120 × 32 mm

- luminous flux: 100 lm
- color temperature: 4 000 K
- source of light: LED
- lifetime: 30 000 hours



**4 000 K**  
NEUTRAL  
WHITE



**ZC0114** 1/-/-/18  
15 45 000 140 ZC0114

- colour: dark grey
- light color: neutral white
- IP rating: IP65
- material of the diffuser: polycarbonate
- body material: ABS
- voltage: 220–240 V
- packaging: 1 pc, box
- power: 1.5 W
- dimensions: 100 × 60 × 33 mm

- luminous flux: 80 lm
- color temperature: 4 000 K
- source of light: LED
- lifetime: 30 000 hours



**4 000 K**  
NEUTRAL  
WHITE



**ZC0116** 1/-/-/40  
15 45 000 160 ZC0116

- colour: dark grey
- light color: neutral white
- IP rating: IP65
- material of the diffuser: polycarbonate
- body material: ABS
- voltage: 220–240 V
- packaging: 1 pc, box
- power: 3 W
- dimensions: 160 × 70 × 33 mm

- luminous flux: 150 lm
- color temperature: 4 000 K
- source of light: LED
- lifetime: 30 000 hours



**4 000 K**  
NEUTRAL  
WHITE



**ZC0117** 1/-/-/30  
15 45 000 170 ZC0117

## Luminaires

## Cabinet Luminaires

## CLASSIC

## TIGO

## CLASSIC

- energy-saving LED bars for embellishing a closet or kitchen unit
- lengths from 300 mm to 1 150 mm
- option to interconnect different lengths
- neutral white colour temperature
- simple installation

- power: 5 W
- length: 300 mm
- luminous flux: 500 lm
- color temperature: 4 000 K
- light color: neutral white
- material: aluminium (Al) + plastic
- dimensions: 300 × 22 × 30 mm
- lifetime: 25 000 hours
- beam angle: 120°

= packaging: 1 pc, small box

4 000 K  
NEUTRAL  
WHITE**ZS2110**

15 31 211 010

1/-/-/30

ZS2110

- power: 10 W
- length: 600 mm
- luminous flux: 1 000 lm
- color temperature: 4 000 K
- light color: neutral white
- material: aluminium (Al) + plastic
- dimensions: 600 × 22 × 30 mm
- lifetime: 25 000 hours
- beam angle: 120°

= packaging: 1 pc, small box

4 000 K  
NEUTRAL  
WHITE**ZS2120**

15 31 211 020

1/-/-/30

ZS2120

- power: 15 W
- length: 860 mm
- luminous flux: 1 500 lm
- color temperature: 4 000 K
- light color: neutral white
- material: aluminium (Al) + plastic
- dimensions: 860 × 22 × 30 mm
- lifetime: 25 000 hours
- beam angle: 120°

= packaging: 1 pc, small box

4 000 K  
NEUTRAL  
WHITE**ZS2130**

15 31 211 030

1/-/-/30

ZS2130

- power: 20 W
  - length: 1 150 mm
  - luminous flux: 2 000 lm
  - color temperature: 4 000 K
  - light color: neutral white
  - material: aluminium (Al) + plastic
  - dimensions: 1 150 × 22 × 30 mm
  - lifetime: 25 000 hours
  - beam angle: 120°
- packaging: 1 pc, small box



4 000 K  
NEUTRAL  
WHITE



**ZS2140**  
15 31 211 040

1/-/-/30  
ZS2140

## Luminaires

### Desk and Floor Lamps

- stylish table or floor lamps
- suitable for the study or children's room
- selected models allow wireless charging of mobile phones,
- night light function, timer or dimming function
- retro lamps with E27 base

- model: MIA
  - power: 5.6 W
  - luminous flux: 150 lm
  - colour: black
  - supply cable length: 1 m
  - power adaptor: USB
  - power adaptor included: yes (USB cable)
  - color temperature: 3 000/5 000/6 500 K
  - dimensions: 30 cm
- color rendering index (CRI): Ra >95
- packaging: 1 pc, box



**Z7625**  
15 38 189 000

1/-/-/20  
Z7625

- model: LUCY
  - power: 2 W
  - luminous flux: 100 lm
  - colour: white
  - supply cable length: 1 m
  - power adaptor: USB cable
  - power adaptor included: yes (USB cable)
  - color temperature: 5 000 K
  - dimensions: 80 × 80 × 300 mm
- color rendering index (CRI): Ra >80
- packaging: 1 pc, box



**Z7626**  
15 38 190 000

1/-/-/6  
Z7626



- model: EMILY
- power: 2 W
- luminous flux: 100 lm
- colour: white
- supply cable length: 1 m
- power adaptor: USB cable
- power adaptor included: yes (USB cable)
- color temperature: 5 000 K
- dimensions: 80 × 80 × 300 mm

- color rendering index (CRI): Ra >80
- packaging: 1 pc, box



**Z7627** 1/-/-16  
15 38 191 000 Z7627



- model: CHARLES
- power: 7.6 W
- luminous flux: 550 lm
- colour: white
- supply cable length: 1.3 m
- power adaptor: 12 V/450 mA
- power adaptor included
- color temperature: 3 000-6 500 K
- dimensions: 420 × 165 × 165 mm

- color rendering index (CRI): Ra >80
- packaging: 1 pc, box

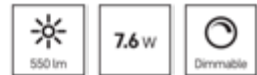

**Z7628W** 1/-/-2  
15 38 192 000 Z7628W



- model: CHARLES
- power: 7.6 W
- luminous flux: 550 lm
- colour: black
- supply cable length: 1.3 m
- power adaptor: 12 V/450 mA
- power adaptor included
- color temperature: 3 000-6 500 K
- dimensions: 420 × 165 × 165 mm

- color rendering index (CRI): Ra >80
- packaging: 1 pc, box



**Z7628B** 1/-/-2  
15 38 193 000 Z7628B



- model: LILY
- power: 13.5
- luminous flux: 760 lm
- colour: white
- supply cable length: 1.5 m
- power adaptor: 10 V/1 A
- power adaptor included
- color temperature: 3 000/4 000/6 500 K
- dimensions: 330 × 130 × 150 mm

- color rendering index (CRI): Ra >80
- packaging: 1 pc, box



**Z7629W** 1/-/-4  
15 38 194 000 Z7629W



- model: LILY
- power: 13.5
- luminous flux: 760 lm
- colour: black
- supply cable length: 1.5 m
- power adaptor: 10 V/1 A
- power adaptor included
- color temperature: 3 000/4 000/6 500 K
- dimensions: 330 × 130 × 150 mm

- color rendering index (CRI): Ra >90
- packaging: 1 pc, box



**Z7629B** 1/-/-4  
15 38 195 000 Z7629B



- model: KATIE
- power: 4 W
- luminous flux: 250 lm
- colour: white
- supply cable length: 1.5 m
- power adaptor: 5 V/1 A
- power adaptor included
- color temperature: 3 000/4 000/5 000 K
- dimensions: 330 × 130 × 150 mm

= packaging: 1 pc, box



**Z7630W**  
15 38 196 000

1/-/-/2  
Z7630W

- model: KATIE
- power: 4 W
- luminous flux: 250 lm
- colour: black
- supply cable length: 1.5 m
- power adaptor: 5 V/1 A
- power adaptor included
- color temperature: 3 000/4 000/5 000 K
- dimensions: 330 × 130 × 150 mm

= packaging: 1 pc, box



**Z7630B**  
15 38 197 000

1/-/-/2  
Z7630B

- model: AVA
- power: 5.6 W
- luminous flux: 200 lm
- colour: black
- supply cable length: 1.5 m
- power adaptor: USB cable
- power adaptor included: yes (USB cable)
- color temperature: 3 000/4 000/5 000 K
- dimensions: 460 × 105 × 53 mm

= color rendering index (CRI): Ra >95  
= packaging: 1 pc, box



**Z7617**  
15 38 179 000

1/-/-/10  
Z7617

- model: CARSON
- power: 6 W
- luminous flux: 400 lm
- colour: black
- supply cable length: 1.5 m
- power adaptor: 12 V/1 000 mA
- power adaptor included
- color temperature: 2 700–6 600 K
- dimensions: 330 × 290 mm

= USB port  
= color rendering index (CRI): Ra >80  
= packaging: 1 pc, box



**Z7618B**  
15 38 180 000

1/-/-/6  
Z7618B

- model: CARSON
- power: 6 W
- luminous flux: 400 lm
- colour: white
- supply cable length: 1.5 m
- power adaptor: 12 V/1 000 mA
- power adaptor included
- color temperature: 2 700–6 600 K
- dimensions: 330 × 290 mm

= USB port  
= color rendering index (CRI): Ra >80  
= packaging: 1 pc, box



**Z7618W**  
15 38 181 000

1/-/-/6  
Z7618W

- model: CHASE
- power: 7.8 W
- luminous flux: 450 lm
- colour: black
- supply cable length: 1.5 m
- power adaptor: 12 V/500 mA
- power adaptor included
- color temperature: 2 700–6 500 K
- dimensions: 370 × 340 mm

- color rendering index (CRI): Ra >80
- packaging: 1 pc, box



**Z7619B**  
15 38 182 000

1/-/-8  
Z7619B

- model: CHASE
- power: 7.8 W
- luminous flux: 450 lm
- colour: white
- supply cable length: 1.5 m
- power adaptor: 12 V/500 mA
- power adaptor included
- color temperature: 2 700–6 500 K
- dimensions: 370 × 340 mm

- color rendering index (CRI): Ra >80
- packaging: 1 pc, box



**Z7619W**  
15 38 183 000

1/-/-8  
Z7619W

- model: WESLEY
- power: 12 W
- luminous flux: 700 lm
- colour: black
- supply cable length: 1.5 m
- power adaptor: 15 V/800 mA
- power adaptor included
- color temperature: 2 700–6 000 K
- dimensions: 430 × 180 mm

- color rendering index (CRI): Ra >95
- packaging: 1 pc, box



**Z7620B**  
15 38 184 000

1/-/-2  
Z7620B

- model: WESLEY
- power: 12 W
- luminous flux: 700 lm
- colour: white
- supply cable length: 1.5 m
- power adaptor: 15 V/800 mA
- power adaptor included
- color temperature: 2 700–6 000 K
- dimensions: 430 × 180 mm

- color rendering index (CRI): Ra >95
- packaging: 1 pc, box



**Z7620W**  
15 38 185 000

1/-/-2  
Z7620W

- model: KAREN
- power: 9.2 W
- luminous flux: 640 lm
- colour: black
- supply cable length: 1,3 m
- power adaptor: USB cable
- power adaptor included: yes (USB cable)
- color temperature: 3 000/4 000/6 000 K
- dimensions: 200 × 550 × 700 mm

- USB port: no + wireless charging
- color rendering index (CRI): Ra >80
- packaging: 1 pc, box



**Z7615**  
15 38 176 000

1/-/-5  
Z7615

- model: STELLA
- power: 6.5 W
- luminous flux: 400 lm
- colour: blue
- supply cable length: 1.7 m
- power adaptor: 12 V/400 mA
- power adaptor included
- number of LED: 12
- color temperature: 4 000 K

- dimensions: 160 × 550 × 345 mm
- color rendering index (CRI): Ra >80
- packaging: 1 pc, box

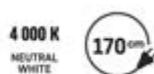
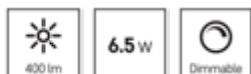

**Z7602BL** 1/-/-/4  
15 38 157 000 Z7602BL

- model: STELLA
- power: 6.5 W
- luminous flux: 400 lm
- colour: pink
- supply cable length: 1.7 m
- power adaptor: 12 V/400 mA
- power adaptor included
- number of LED: 12
- color temperature: 4 000 K

- dimensions: 160 × 550 × 345 mm
- color rendering index (CRI): Ra >80
- packaging: 1 pc, box

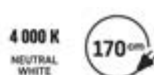

**Z7602P** 1/-/-/4  
15 38 156 000 Z7602P

- model: STELLA
- power: 6.5 W
- luminous flux: 400 lm
- colour: black
- supply cable length: 1.7 m
- power adaptor: 12 V/400 mA
- power adaptor included
- color temperature: 4 000 K
- dimensions: 160 × 550 × 345 mm

- color rendering index (CRI): Ra >80
- packaging: 1 pc, box



**Z7602B** 1/-/-/4  
15 38 155 000 Z7602B

- model: STELLA
- power: 6.5 W
- luminous flux: 400 lm
- colour: white
- supply cable length: 1.7 m
- power adaptor: 12 V/400 mA
- power adaptor included
- number of LED: 12
- color temperature: 4 000 K

- dimensions: 160 × 550 × 345 mm
- color rendering index (CRI): Ra >80
- packaging: 1 pc, box

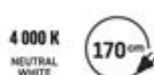

**Z7602W** 1/-/-/4  
15 38 154 000 Z7602W

- model: EDDY
- power: 6 W
- luminous flux: 480 lm
- colour: white
- supply cable length: 1.8 m
- power adaptor: 12 V/0.36 A
- power adaptor included
- number of LED: 24
- color temperature: 3 000/4 500/6 800 K

- dimensions: 170 × 105 × 350 mm
- color rendering index (CRI): Ra > 83
- packaging: 1 pc, box



**Z7599W** 1/-/-/6  
15 38 150 201 Z7599W

- model: EDDY
- power: 6 W
- luminous flux: 480 lm
- colour: black
- supply cable length: 1.8 m
- power adaptor: 12 V/0.36 A
- power adaptor included
- number of LED: 24
- color temperature: 3 000/4 500/6 800 K

- dimensions: 170 × 105 × 350 mm
- color rendering index (CRI): Ra > 83
- packaging: 1 pc, box



**Z7599B** 1/-/-/6  
15 38 150 200 Z7599B

- model: JULIAN
- colour: black
- supply cable length: 1.5 m
- power adaptor: 220-240 V
- dimensions: 460 × 200 mm
- packaging: 1 pc, box



**Z7621B** 1/-/-/2  
15 38 186 000 Z7621B

- model: JULIAN
- colour: white
- supply cable length: 1.5 m
- power adaptor: 220-240 V
- dimensions: 460 × 200 mm
- packaging: 1 pc, box



**Z7621W** 1/-/-/2  
15 38 187 000 Z7621W

- model: JULIAN
- colour: blue
- supply cable length: 1.5 m
- power adaptor: 220-240 V
- dimensions: 460 × 200 mm
- packaging: 1 pc, box



**Z7621BL** 1/-/-/2  
15 38 188 000 Z7621BL

- model: LUCAS
- colour: white
- supply cable length: 1.5 m
- power adaptor: 220-240 V
- dimensions: 480 × 155 × 330 mm
- packaging: 1 pc, box



**Z7609W** 1/-/-/2  
15 38 169 000 Z7609W



- model: ARTHUR
- colour: dark grey
- supply cable length: 1.8 m
- power adaptor: 220-240 V
- dimensions: 850 × 280 × 1 510 mm
- packaging: 1 pc, box



**Z7610**

1/-/-/1

15 38 170 000

Z7610

## Sensors

- products with PIR and MW technology
- MW sensors are less demanding on placement than PIR
- also function as switches for lights, outdoor floodlights or alarms
- detection angle of either 180° or 360° and range of 6-12 m
- selected products can also send a command to open doors or gate

- detection angle: 360°
- detection distance: 6 m
- switching time: 5 s, 30 s, 1 min, 3 min, 5 min, 8 min
- IP rating: IP20
- sensor type: PIR
- power source: 230 V~/50 Hz
- max. resistive load: 800 W
- packaging: 1 pc, small box



**G1110**

1/-/-/80

14 54 007 100

G1110

- detection angle: 180°
- detection distance: 12 m
- switching time: min. 10 seconds – max. 7 minutes
- IP rating: IP44
- sensor type: PIR
- power source: 230 V~/50 Hz
- max. resistive load: 1200 W
- packaging: 1 pc, small box



**G1120**

1/-/-/40

14 54 007 200

G1120

- detection angle: 180°
- detection distance: 12 m
- switching time: min. 10 seconds – max. 7 minutes
- IP rating: IP44
- sensor type: PIR
- power source: 230 V~/50 Hz
- max. resistive load: 1200 W
- packaging: 1 pc, small box



**G1125**

1/-/-/40

14 54 007 250

G1125

- detection angle: 360°
- detection distance: 6 m
- switching time: min. 10 seconds – max. 7 minutes
- IP rating: IP20
- sensor type: PIR
- power source: 230 V~/50 Hz
- max. resistive load: 1200 W
- packaging: 1 pc, small box



**G1130** 1/-/-/20  
14 54 008 100 G1130

- detection angle: 360°
- detection distance: 6 m
- switching time: min. 10 sekunds – max. 15 minutes
- IP rating: IP20
- sensor type: PIR
- power source: 230 V~/50 Hz
- max. resistive load: 2 000 W
- packaging: 1 pc, small box



**G1150** 1/-/-/20  
14 54 009 200 G1150

- detection angle: 360°
- detection distance: 6 m
- switching time: min. 10 sekunds – max. 15 minutes
- IP rating: IP20
- sensor type: PIR
- power source: 230 V~/50 Hz
- max. resistive load: 1200 W
- packaging: 1 pc, small box



**G1160** 1/-/-/36  
14 54 010 100 G1160

- detection angle: 180°
- detection distance: 12 m
- switching time: min. 10 sekunds – max. 15 minutes
- IP rating: IP65
- sensor type: PIR
- power source: 230 V~/50 Hz
- max. resistive load: 1200 W
- packaging: 1 pc, small box



**G1240** 1/-/-/40  
14 54 015 100 G1240

- detection angle: 360°
- detection distance: 8 m
- switching time: min. 10 seconds – max. 12 minutes
- IP rating: IP20
- sensor type: microwave
- power source: 230 V~/50 Hz
- max. resistive load: 1200 W
- packaging: 1 pc, small box



**G1180** 1/-/-/24  
14 54 012 100 G1180

- detection angle: 360°
- detection distance: 8 m
- switching time: min. 10 seconds – max. 12 minutes
- IP rating: IP20
- sensor type: microwave
- power source: 230 V~/50 Hz
- max. resistive load: 1200 W
- packaging: 1 pc, small box



**G1190** 1/-/-/24  
14 54 013 100 G1190

- detection angle: 360°
- detection distance: 15 m
- switching time: min. 10 seconds – max. 12 minutes
- IP rating: IP20
- sensor type: microwave
- power source: 230 V~/50 Hz
- max. resistive load: 1200 W
- packaging: 1 pc, small box



**G1210** 1/-/-/80  
14 54 014 100 G1210

## Decorations

### Smart chains

### Chains GoSmart

- 64 lighting modes for a festive atmosphere
- Timer function for scheduled on/off
- Music synchronization for rhythmic blinking
- Various lengths 8–24 m, suitable for both indoor and outdoor use
- Connection to the home network via Wi-Fi protocol
- Compatibility with EMOS GoSmart products and TUYA devices
- Voice control with Google Assistant and Amazon Alexa

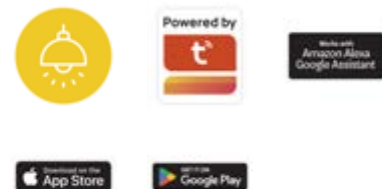

- product: chain
- light color: RGB
- dimensions: 8 m
- area of use: both outdoor and indoor
- timer
- remote control: no
- number of LED: 80
- supply line length: 5 m
- power: 8.4 W
- IP rating: IP44
- lifetime: 10 000 hours
- supported OS: Android, iOS
- compatibility: EMOS GoSmart, TUYA, LIDL, Smartlife,
- protocol: Wi-Fi
- transmission frequency: 2,4 GHz Wi-Fi
- control by voice assistants
- notifications to the mobile app
- application languages: EN, CZ, SK, PL, DE, HU, SI, FR,



**D4ZR01** 1/-/-/30  
15 50 044 028 D4ZR01



www.emos.eu

Order Code  
Item Number

Packaging  
Type

- product: chain
- light color: RGB
- dimensions: 12 m
- area of use: both outdoor and indoor
- timer
- remote control: no
- number of LED: 120
- supply line length: 5 m
- power: 8.4 W

- IP rating: IP44
- lifetime: 10 000 hours
- supported OS: Android, iOS
- compatibility: EMOS GoSmart, TUYA, LIDL, Smartlife,
- protocol: Wi-Fi
- transmission frequency: 2,4 GHz Wi-Fi
- control by voice assistants
- notifications to the mobile app
- application languages: EN, CZ, SK, PL, DE, HU, SI, FR,



**D4ZR02** 1/-/-/25  
15 50 044 029 D4ZR02

- product: chain
- light color: RGB
- dimensions: 18 m
- area of use: both outdoor and indoor
- timer
- remote control: no
- number of LED: 180
- supply line length: 5 m
- power: 8.4 W

- IP rating: IP44
- lifetime: 10 000 hours
- supported OS: Android, iOS
- compatibility: EMOS GoSmart, TUYA, LIDL, Smartlife,
- protocol: Wi-Fi
- transmission frequency: 2,4 GHz Wi-Fi
- control by voice assistants
- notifications to the mobile app
- application languages: EN, CZ, SK, PL, DE, HU, SI, FR,



**D4ZR03** 1/-/-/20  
15 50 044 030 D4ZR03

- product: chain
- light color: RGB
- dimensions: 24 m
- area of use: both outdoor and indoor
- timer
- remote control: no
- number of LED: 240
- supply line length: 5 m
- power: 8.4 W

- IP rating: IP44
- lifetime: 10 000 hours
- supported OS: Android, iOS
- compatibility: EMOS GoSmart, TUYA, LIDL, Smartlife,
- protocol: Wi-Fi
- transmission frequency: 2,4 GHz Wi-Fi
- control by voice assistants
- notifications to the mobile app
- application languages: EN, CZ, SK, PL, DE, HU, SI, FR,





















**D4ZR04** 1/-/-/16  
15 50 044 031 D4ZR04

## Decorations





## Decorations





## Party

<p><b>DCPW01</b></p> <p>15 50 000 000</p>  <p>8 592920 093207</p> <ul style="list-style-type: none"> <li>product: garland</li> <li>light color: warm white</li> <li>dimensions: 5 m</li> <li>area of use: both outdoor and indoor</li> <li>timer: no</li> <li>remote control: no</li> </ul>	<p>1/-/-6</p> <p>ZY1939</p>   <ul style="list-style-type: none"> <li>number of LED: 50</li> <li>supply line length: 5 m</li> <li>power: 5 W</li> <li>IP rating: IP44</li> <li>lifetime: 10 000 hours</li> </ul>		<p><b>DCPW02</b></p> <p>15 50 000 001</p>  <p>8 592920 093214</p> <ul style="list-style-type: none"> <li>product: garland</li> <li>light color: warm white</li> <li>dimensions: 5 m</li> <li>area of use: both outdoor and indoor</li> <li>timer: no</li> <li>remote control: no</li> </ul>	<p>1/-/-6</p> <p>ZY2053</p>   <ul style="list-style-type: none"> <li>number of LED: 50</li> <li>supply line length: 5 m</li> <li>power: 6 W</li> <li>IP rating: IP44</li> <li>lifetime: 10 000 hours</li> </ul>	
<p><b>DCPV01</b></p> <p>15 50 001 023</p>  <p>8 592920 099070</p> <ul style="list-style-type: none"> <li>product: garland</li> <li>light color: vintage</li> <li>dimensions: 4.5 m</li> <li>area of use: both outdoor and indoor</li> <li>timer: no</li> <li>remote control: no</li> </ul>	<p>1/-/-8</p> <p>DCPV01</p>   <ul style="list-style-type: none"> <li>number of LED: 100</li> <li>supply line length: 5 m</li> <li>power: 5 W</li> <li>IP rating: IP44</li> <li>lifetime: 10 000 hours</li> </ul>		<p><b>DCPM01</b></p> <p>15 50 004 000</p>  <p>8 592920 094013</p> <ul style="list-style-type: none"> <li>product: garland</li> <li>light color: multicolor</li> <li>dimensions: 5 m</li> <li>area of use: both outdoor and indoor</li> <li>timer: no</li> <li>remote control: no</li> </ul>	<p>1/-/-6</p> <p>ZY1938</p>   <ul style="list-style-type: none"> <li>number of LED: 50</li> <li>supply line length: 5 m</li> <li>power: 6 W</li> <li>IP rating: IP44</li> <li>lifetime: 10 000 hours</li> </ul>	
<p><b>DCPZ01</b></p> <p>15 50 005 000</p>  <p>8 592920 094020</p> <ul style="list-style-type: none"> <li>dimensions: 7.35 m</li> <li>area of use: both outdoor and indoor</li> <li>timer: no</li> <li>remote control: no</li> <li>supply line length: 5 m</li> <li>power: 750 W max.</li> </ul>	<p>1/-/-2</p> <p>ZY2293</p>   <ul style="list-style-type: none"> <li>IP rating: IP44</li> <li>lifetime: 10 000 hours</li> </ul>		<p><b>DCPZ02</b></p> <p>15 50 005 001</p>  <p>8 592920 094037</p> <ul style="list-style-type: none"> <li>dimensions: 7.35 m</li> <li>area of use: both outdoor and indoor</li> <li>timer: no</li> <li>remote control: no</li> <li>power: 750 W max.</li> <li>IP rating: IP44</li> </ul>	<p>1/-/-2</p> <p>ZY2294</p>   <ul style="list-style-type: none"> <li>lifetime: 10 000 hours</li> </ul>	













<b>DCPW04</b>	1/-/-/6	
15 50 005 016	DCPW04	
	 	
8 592920 09955 1		
<ul style="list-style-type: none"> <li>▪ product: garland</li> <li>▪ light color: warm white</li> <li>▪ dimensions: 7.6 m</li> <li>▪ area of use: both outdoor and indoor</li> <li>▪ timer: no</li> <li>▪ remote control: no</li> </ul>	<ul style="list-style-type: none"> <li>▪ number of LED: 16</li> <li>▪ supply line length: 5 m</li> <li>▪ power: 6 W</li> <li>▪ IP rating: IP44</li> <li>▪ lifetime: 10 000 hours</li> </ul>	





<b>DCPW07</b>	1/-/-/6	
15 50 005 019	DCPW07	
	 	
8 592920 11082 9		
<ul style="list-style-type: none"> <li>▪ product: garland</li> <li>▪ light color: warm white</li> <li>▪ dimensions: 7.6 m</li> <li>▪ area of use: both outdoor and indoor</li> <li>▪ timer: no</li> <li>▪ remote control: no</li> </ul>	<ul style="list-style-type: none"> <li>▪ number of LED: 20</li> <li>▪ supply line length: 5 m</li> <li>▪ power: 6 W</li> <li>▪ IP rating: IP44</li> <li>▪ lifetime: 10 000 hours</li> </ul>	





## Lantern

<b>DCLV01</b>	1/-/-/15	
15 50 001 013	ZY2114	
	 	
8 592920 09377 1		
<ul style="list-style-type: none"> <li>▪ product: lantern</li> <li>▪ light color: vintage</li> <li>▪ dimensions: 10.5 × 24 cm</li> <li>▪ area of use: indoor</li> <li>▪ timer</li> <li>▪ remote control: no</li> </ul>	<ul style="list-style-type: none"> <li>▪ number of LED: 1</li> <li>▪ power: 0.06 W</li> <li>▪ IP rating: IP20</li> <li>▪ lifetime: 10 000 hours</li> </ul>	

<b>DCLV02</b>	1/-/-/15	
15 50 001 014	ZY2115	
	 	
8 592920 09378 8		
<ul style="list-style-type: none"> <li>▪ product: lantern</li> <li>▪ light color: vintage</li> <li>▪ dimensions: 10.5 × 24 cm</li> <li>▪ area of use: indoor</li> <li>▪ timer</li> <li>▪ remote control: no</li> </ul>	<ul style="list-style-type: none"> <li>▪ number of LED: 1</li> <li>▪ power: 0.06 W</li> <li>▪ IP rating: IP20</li> <li>▪ lifetime: 10 000 hours</li> </ul>	

## LED candles

<b>DCCV06</b>	1/-/-/8	
15 50 001 005	ZY2141	
	 	
8 592920 09369 6		
<ul style="list-style-type: none"> <li>▪ product: candle</li> <li>▪ light color: vintage</li> <li>▪ dimensions: 7.5 × 10/12.5/15 cm</li> <li>▪ area of use: indoor</li> <li>▪ timer</li> <li>▪ remote control: yes (1× CR2032, include)</li> </ul>	<ul style="list-style-type: none"> <li>▪ number of LED: 3× 1</li> <li>▪ power: 0.06 W</li> <li>▪ IP rating: IP20</li> <li>▪ lifetime: 10 000 hours</li> </ul>	

<b>DCCV07</b>	1/-/-/8	
15 50 001 006	ZY2143	
	 	
8 592920 09370 2		
<ul style="list-style-type: none"> <li>▪ product: candle</li> <li>▪ light color: vintage</li> <li>▪ dimensions: 7.5 × 10/12.5/15 cm</li> <li>▪ area of use: indoor</li> <li>▪ timer</li> <li>▪ remote control: yes (1× CR2032, include)</li> </ul>	<ul style="list-style-type: none"> <li>▪ number of LED: 3× 1</li> <li>▪ power: 0.06 W</li> <li>▪ IP rating: IP20</li> <li>▪ lifetime: 10 000 hours</li> </ul>	

**DCCV11**

6/-/-216

15 50 001 010

ZY2149



- product: candle
- light color: vintage
- dimensions: 3.8 × 3.8 cm
- area of use: indoor
- timer: no
- remote control: no

- number of LED: 6 × 1
- power: 0.06 W
- IP rating: IP20
- lifetime: 10 000 hours

**DCCV12**

6/-/-216

15 50 001 011

ZY2150



- product: candle
- light color: vintage
- dimensions: 3.8 × 3.8 cm
- area of use: indoor
- timer: no
- remote control: no

- number of LED: 6 × 1
- power: 0.06 W
- IP rating: IP20
- lifetime: 10 000 hours

**DCCV13**

6/-/-216

15 50 001 012

ZY2151



- product: candle
- light color: vintage
- dimensions: 3.8 × 3.8 cm
- area of use: indoor
- timer: no
- remote control: no

- number of LED: 6 × 1
- power: 0.06 W
- IP rating: IP20
- lifetime: 10 000 hours

**DCCV19**

1/-/-35

15 50 000 056

ZY2371T



- product: grave candle
- light color: warm white
- dimensions: 7 × 12.5 cm
- area of use: both outdoor and indoor
- timer
- remote control: no

- number of LED: 1
- power: 0.06 W
- IP rating: IP44
- lifetime: 10 000 hours

**DCCV20**

1/-/-35

15 50 000 057

ZY2372



- product: grave candle
- light color: warm white
- dimensions: 7 × 12.5 cm
- area of use: both outdoor and indoor
- timer: sensor
- remote control: no

- number of LED: 1
- power: 0.06 W
- IP rating: IP44
- lifetime: 10 000 hours

**DCCV21**

1/-/-24

15 50 001 024

DCCV21



- product: grave candle
- light color: vintage
- dimensions: 7 × 12.5 cm
- area of use: both outdoor and indoor
- timer
- remote control: no

- number of LED: 1
- power: 0.06 W
- IP rating: IP44
- lifetime: 10 000 hours

**DCCV22**

1/-/-24

15 50 001 029

DCCV22



- product: grave candle
- light color: vintage
- dimensions: 7.5 × 25 cm
- area of use: both outdoor and indoor
- timer: no
- remote control: no

- number of LED: 1
- power: 0.06 W
- IP rating: IP44
- lifetime: 1 500 hours

# Weather stations, thermometers, scales, others



## Weather stations

### Weather stations

- can assess current weather and forecast
- display temperature and humidity (in and out), time and date
- wireless comm. with up to 3 sensors (powered by AA or AAA)
- large colour display, LED backlight (perm/temp) & projector
- with stand/for hanging on the wall, battery or mains powered

clock: DCF (radio controlled clock) = LED backlight display = the possibility of hanging on the wall = time zones = date = calendar = alarm clock: yes, 2x = outdoor temperature: -30 °C to +60 °C, resolutions 0.1 °C = indoor temperature: -10 °C to +50 °C, resolution 0.1 °C = outdoor humidity: 1 % až 99 % RV, resolution 1 % = indoor humidity: 1 % to 99 % RH, resolution 1 % = min. and max. temperature = weather forecast = temperature warning = pressure trend = barometer = rain gauge = anemometer = altitude adjustment = moon phase = range of the sensor: up to 100 m = possible additional sensor: up to 3 temperature and humidity sensors (E06018), 1 anemometer sensor (E06016) = power of sensor: 4x 1.5 V AA (not included) = power of station: 3x 1.5 V AAA (not included) = AC adapter: yes, 5 V DC/300 mA (included) = main unit size: 17 × 192 ×



**E6016**  
26 06 164 000

1/-/-/1  
E6016

clock: DCF (radio controlled clock) = color backlight display (Black Mask) = date = calendar = alarm clock: yes, 2x = outdoor temperature: -20 °C to +60 °C, resolution 0.1 °C = indoor temperature: -5 °C to +50 °C, resolution 0.1 °C = min. and max. temperature = weather forecast = rain gauge: no = anemometer: no = range of the sensor: up to 30 m = possible additional sensor: 3 (E08400) = power of sensor: 2x 1.5 V AA (not included) = power of station: 1x CR2032 (included) = AC adapter: yes, 4.5 V DC/300 mA (included) = main unit size: 56 × 163 × 80 mm



**E8466**  
26 06 150 000

1/-/-/8  
E8466



www.emos.eu

Order Code  
Item Number

Packaging  
Type

clock: DCF (radio controlled clock) = LED backlight display = the possibility of hanging on the wall = color backlight display (Black Mask) = time zones = date = calendar = alarm clock: yes, 2x = outdoor temperature: -40 °C to +70 °C, resolution 0.1 °C = indoor temperature: -10 °C to +50 °C, resolution 0.1 °C = outdoor humidity: 20 % to 95 % RH, resolution 1 % = indoor humidity: 1 % to 99 % RH, resolution 1 % = min. and max. temperature = weather forecast = pressure trend = barometer = rain gauge: no = anemometer: no = moon phase = range of the sensor: up to 50 m = possible additional sensor: 3 (E05018) = wired probe for sensor: 0.95 m = power of sensor: 2x 1.5 V AAA (not included) = power of station: 3x 1.5 V AAA (not included) = AC adapter: yes, 5 V DC/600 mA (included) = main unit size: 26 × 197 × 125 mm



**E5111**  
26 06 170 000

1/-/-8  
E5111



clock: DCF (radio controlled clock) = LED backlight display = the possibility of hanging on the wall = color backlight display (Black Mask) = time zones = date = calendar = alarm clock: yes, 2x = outdoor temperature: -50 °C to +70 °C, resolution 0.1 °C = indoor temperature: -10 °C to +50 °C, resolution 0.1 °C = outdoor humidity: 1 % až 99 % RV, resolution 1 % = indoor humidity: 1 % to 99 % RH, resolution 1 % = min. and max. temperature = weather forecast = temperature warning = pressure trend = barometer = rain gauge: no = anemometer: no = altitude adjustment = moon phase = range of the sensor: up to 100 m = possible additional sensor: 3 (E06018) = power of sensor: 2x 1.5 V AAA (not included) = power of station: 3x 1.5 V AAA (not included) = AC adapter: yes, 5 V DC/300 mA (included) = main unit size: 17 × 192 × 127 mm



**E6018**  
26 06 162 000

1/-/-12  
E6018



clock: DCF (radio controlled clock) = LED backlight display = the possibility of hanging on the wall = time zones = date = calendar = alarm clock: yes, 2x = outdoor temperature: -40 °C to +70 °C, resolution 0.1 °C = indoor temperature: -10 °C to +50 °C, resolution 0.1 °C = outdoor humidity: 20 % to 95 % RH, resolution 1 % = indoor humidity: 1 % to 99 % RH, resolution 1 % = min. and max. temperature = weather forecast = pressure trend = barometer = rain gauge: no = anemometer: no = altitude adjustment = range of the sensor: up to 30 m = possible additional sensor: 3 (E05018) = wired probe for sensor = power of sensor: 2x 1.5 V AAA (not included) = power of station: 3x 1.5 V AA (not included) = main unit size: 27 × 130 × 130 mm



**E5080**  
26 06 169 000

1/-/-12  
E5080



clock: DCF (radio controlled clock) = LED backlight display = time zones = date = calendar = alarm clock = outdoor temperature: -50 °C to +70 °C, resolution 0.1 °C = indoor temperature: -10 °C to +50 °C, resolution 0.1 °C = outdoor humidity: 20 % to 95 %, resolution 1 % = indoor humidity: 20 % to 95 %, resolution 1 % = min. and max. temperature = weather forecast = temperature warning = rain gauge: no = anemometer: no = moon phase = range of the sensor: up to 30 m = possible additional sensor: 3 (E05018) = power of sensor: 2x 1.5 V AAA (not included) = power of station: 2x 1.5 V AA (not included) = main unit size: 50 × 120 × 180 mm



**E3003**  
26 06 153 000

1/-/-10  
E3003



clock: DCF (radio controlled clock) = LED backlight display = time zones = date = calendar = alarm clock = outdoor temperature: -30 °C to +60 °C, resolutions 0.1 °C = indoor temperature: 0 °C to +50 °C, resolution 0.1 °C = indoor humidity: 20 % to 90 % RH, resolution 1 % = weather forecast = rain gauge: no = anemometer: no = moon phase = range of the sensor: up to 30 m = possible additional sensor: 3 (E03070) = power of sensor: 2x 1.5 V AAA (not included) = power of station: 3x 1.5 V AAA (not included) = main unit size: 52 × 139 × 100 mm



**E3070**  
26 06 139 000

1/-/-18  
E3070





www.emos.eu

Order Code  
Item Number

Packaging  
Type

clock: DCF (radio controlled clock) = the possibility of hanging on the wall = time zones = date = calendar = alarm clock = outdoor temperature: -40 °C to +60 °C, resolution 0.1 °C = indoor temperature: -10 °C to +50 °C, resolution 0.1 °C = outdoor humidity: 20 % to 95 % RH, resolution 1 % = indoor humidity: 1 % to 99 % RH, resolution 1 % = min. and max. temperature = weather forecast = rain gauge: no = anemometer: no = moon phase = range of the sensor: up to 30 m = possible additional sensor: 3 (E05018) = power of sensor: 2× 1.5 V AA (not included) = power of station: 2× 1.5 V AAA (not included) = main unit size: 23 × 76 × 126 mm



**E0352** 1/-/-/20  
26 06 166 000 E0352

clock: yes, quartz = date = calendar = alarm clock = outdoor temperature: -50 °C to +70 °C, resolution 0.1 °C = indoor temperature: -10 °C to +50 °C, resolution 0.1 °C = indoor humidity: 20 % to 95 % RH, resolution 1 % = min. and max. temperature = weather forecast = rain gauge: no = anemometer: no = moon phase = wired probe for sensor: 1.9 m = power of station: 2× LR1130 (included) = main unit size: 16 × 70 × 109 mm



**E0117N** 1/-/-/80  
26 06 003 000 E0117N

clock: yes, quartz = LED backlight display = the possibility of hanging on the wall = color backlight display (Black Mask) = alarm clock = outdoor temperature: -50 °C to +70 °C, resolution 0.1 °C = indoor temperature: -10 °C to +50 °C, resolution 0.1 °C = outdoor humidity: 20 % to 95 % RH, resolution 1 % = indoor humidity: 20 % to 95 % RH, resolution 1 % = min. and max. temperature = weather forecast = rain gauge: no = anemometer: no = range of the sensor: up to 50 m = power of sensor: 2× 1.5 V AAA (not included) = power of station: 2× 1.5 V AAA (not included) = AC adapter: yes, micro USB 5 V/1 A (not included) = main unit size: 20 × 85 × 96 mm



**E8647** 1/-/-/20  
26 06 172 000 E8647

clock: DCF (radio controlled clock) = LED backlight display = the possibility of hanging on the wall = color backlight display (Black Mask) = time zones = date = calendar = alarm clock = outdoor temperature: -30 °C to +60 °C, resolutions 0.1 °C = indoor temperature: -10 °C to +50 °C, resolution 0.1 °C = outdoor humidity: 10 % to 99 % RH, resolution 1 % = indoor humidity: 10 % to 99 % RH, resolution 1 % = min. and max. temperature = weather forecast = temperature warning = barometer = rain gauge = anemometer: no = range of the sensor: up to 50 m = power of sensor: 2× 1.5 V AA (not included) = power of station: 3× 1.5 V AAA (not included) = AC adapter: yes, 5 V DC/1 000 mA (included) = main unit size: 29 × 205 × 127 mm



**E8670** 1/-/-/6  
26 06 174 000 E8670

clock: DCF (radio controlled clock) = LED backlight display = the possibility of hanging on the wall = color backlight display (Black Mask) = time zones = date = calendar = alarm clock = outdoor temperature: -40 °C to +60 °C, resolution 0.1 °C = indoor temperature: -10 °C to +50 °C, resolution 0.1 °C = outdoor humidity: 1 % až 99 % RV, resolution 1 % = indoor humidity: 1 % to 99 % RH, resolution 1 % = min. and max. temperature = weather forecast = temperature warning = pressure trend = barometer = rain gauge: no = anemometer: no = moon phase = range of the sensor: up to 80 m = possible additional sensor: 3 (E00387) = power of sensor: 2× 1.5 V AA (not included) = power of station: 3× 1.5 V AA (not included) = AC adapter: yes, 5 V DC/1 200 mA (included) = main unit size: 30 × 200 × 130 mm



**E0387** 1/-/-/8  
26 06 176 000 E0387





www.emos.eu

Order Code  
Item Number

Packaging  
Type

clock: DCF (radio controlled clock) = LED backlight display = color backlight display (Black Mask) = time zones = date = calendar = alarm clock = outdoor temperature: -50 °C to +70 °C, resolution 0.1 °C = indoor temperature: -2 °C to +50 °C, resolution 0.1 °C = outdoor humidity: 20 % to 95 % RH, resolution 1 % = indoor humidity: 20 % to 95 % RH, resolution 1 % = min. and max. temperature = weather forecast = temperature warning = pressure trend = barometer = rain gauge: no = anemometer: no = moon phase = range of the sensor: up to 100 m = possible additional sensor: 3 (E00387, E05018) = power of sensor: 2× 1.5 V AAA (not included) = power of station: 2× 1.5 V AA (not included) = AC adapter: yes, USB-C 9 V DC/2 000 mA, 1.5 m (included) = main unit size: 133 × 125 × 110 mm



**E8010**  
26 06 179 000

1/-/-/6  
E8010

## Thermometers

### Thermometers

- displays indoor & outdoor temperature, some also humidity
- wireless or with probe (wire-connected, out the window)
- measures indoor humidity via integrated sensor in the body
- selected models also feature calendar, alarm and ice warning
- hung on wall or window, thermometer & probe battery-powered

thermometer design: wireless = clock: DCF (radio controlled clock) = LED backlight display = time zones = indoor temperature: -9 °C to +50 °C, resolution 0.1 °C = outdoor temperature: -50 °C to +70 °C, resolution 0.1 °C = min. and max. temperature = range in open space: up to 60 m = possible additional sensor: 1 (E05018) = the possibility of hanging on the wall = power of station: 2× 1.5 V AAA (not included) = power of sensor: 2× 1.5 V AAA (not included) = main unit size: 25 × 82 × 152 mm = sensor size: 27 × 60 × 95 mm = screen size: 54 × 74 mm



**E0107**  
26 03 115 000

1/-/-/24  
E0107T

thermometer design: wireless = indoor temperature: -10 °C to +50 °C, resolution 0.1 °C = outdoor temperature: -30 °C to +50 °C, resolutions 0,1 °C = min. and max. temperature = range in open space: up to 80 m = possible additional sensor: 1 (E05018) = the possibility of hanging on the wall = power of station: 2× 1.5 V AAA (not included) = power of sensor: 2× 1.5 V AAA (not included) = main unit size: 91,8 × 20 × 91,8 mm = sensor size: 31 × 19 × 100 mm = screen size: Ø 64 mm



**E0129**  
26 03 119 002

1/-/-/20  
E0129

thermometer design: wireless = indoor temperature: 0 °C to +60 °C, resolution 0.1 °C = outdoor temperature: -40 °C to +60 °C, resolution 0.1 °C = range in open space: up to 100 m = the possibility of hanging on the wall = power of station: 2× 1.5 V AAA (not included) = power of sensor: 2× 1.5 V AAA (not included) = main unit size: 18 × 56 × 85 mm = sensor size: 20 × 49 × 68 mm = screen size: 34 × 39 mm



**E0042** 1/-/-/30  
26 03 118 000 E0042

thermometer design: wireless = clock: DCF (radio controlled clock) = LED backlight display = time zones = date = alarm clock = snooze = indoor temperature: 0 °C to +50 °C, resolution 0.1 °C = outdoor temperature: -20 °C to +60 °C, resolutions 0.1 °C = min. and max. temperature = range in open space: up to 30 m = possible additional sensor: 1 (E05018) = power of station: 2× 1.5 V AAA (not included) = power of sensor: 2× 1.5 V AAA (not included) = main unit size: 30 × 78 × 78 mm = sensor size: 25 × 60 × 95 mm = screen size: 46 × 49 mm



**E0127** 1/-/-/18  
26 03 121 000 E0127

thermometer design: wire = indoor temperature: -10 °C to +50 °C, resolution 1 °C = indoor humidity: 20 % to 99 % RH, resolution 1 % = outdoor temperature: -50 °C to +70 °C, resolution 1 °C = min. and max. temperature = temperature warning = temperature index = wired probe for sensor: 2 m = the possibility of hanging on the wall = power of station: 2× 1.5 V AAA (not included) = main unit size: 22 × 106 × 117 mm = screen size: 64 × 76 mm



**E8471** 1/-/-/40  
26 03 014 000 RS8471

thermometer design: wire = indoor temperature: 0 °C to +60 °C, resolution 0.1 °C = outdoor temperature: -40 °C to +60 °C, resolution 0.1 °C = wired probe for sensor: 2 m, Ø 8 mm = the possibility of hanging on the wall = power of station: 2× 1.5 V AAA (not included) = main unit size: 18 × 57 × 85 mm = screen size: 34 × 40 mm



**E0041** 1/-/-/30  
26 03 013 000 E0041

thermometer design: wireless = clock: yes, quartz = LED backlight display = date = alarm clock = snooze = indoor temperature: 0 °C to +50 °C, resolution 0.1 °C = indoor humidity: 20 % to 90 % RH, resolution 1 % = min. and max. temperature = power of station: 1× 1.5 V AA (not included) = main unit size: 37 × 93 × 93 mm = screen size: 60 × 65 mm



**E0114** 1/5/-/50  
26 03 117 000 E0114



www.emos.eu

Order Code  
Item Number

Packaging  
Type

thermometer design: wire = clock = alarm clock = snooze = indoor temperature: 0 °C to +50 °C, resolution 0.1 °C = indoor humidity: 25 % to 95 % RH, resolution 1 % = outdoor temperature: -40 °C to +60 °C, resolution 0.1 °C = min. and max. temperature = wired probe for sensor: 2,9 m, Ø 4 mm = the possibility of hanging on the wall = power of station: 1× 1.5 V AAA (not included) = main unit size: 23 × 76 × 107 mm = screen size: 46 × 61 mm



**E0121**  
26 03 016 001

1/-/-/20  
E0121



thermometer design: wire = indoor temperature: 0 °C to +60 °C, resolution 0.1 °C = outdoor temperature: -40 °C to +60 °C, resolution 0.1 °C = min. and max. temperature = wired probe for sensor: 0.9 m = the possibility of hanging on the wall = power of station: 2× 1.5 V AAA (not included) = main unit size: 19 × 58 × 75 mm = screen size: 41 × 52 mm



**E0422**  
26 03 016 002

1/-/-/30  
E0422



thermometer design: wireless = clock: yes, quartz = LED backlight display = alarm clock = snooze = indoor temperature: 0 °C to +50 °C, resolution 0.1 °C = outdoor temperature: -30 °C to +60 °C, resolutions 0.1 °C = min. and max. temperature = range in open space: up to 50 m = possible additional sensor: 3 (E05018) = the possibility of hanging on the wall = power of station: 2× 1.5 V AAA (not included) = power of sensor: 2× 1.5 V AAA (not included) = main unit size: 21 × 80 × 110 mm = sensor size: 25 × 50 × 95 mm = screen size: 53 × 81 mm



**E8636**  
26 03 119 003

1/-/-/32  
E8636



thermometer design: wireless = magnet for fixing = indoor temperature: -10 °C to +50 °C, resolution 0.1 °C = indoor humidity: 20 % to 90 % RH, resolution 1 % = the possibility of hanging on the wall = power of station: 1× 3 V CR2032 (included) = main unit size: 46 × 16 × 62 mm = screen size: 34 × 41 mm



**E0345**  
26 03 203 000

1/-/50/100  
ET345TH



# Thermometers GoSmart



- For measuring indoor temperature and humidity
- Display temperature and humidity data history in the app
- Temperature and humidity alerts via alarm
- Small size and elegant design
- Battery powered
- Connection to home network via ZigBee protocol
- Compatibility with EMOS GoSmart products and TUYA devices
- Voice control with Google Assistant and Amazon Alexa

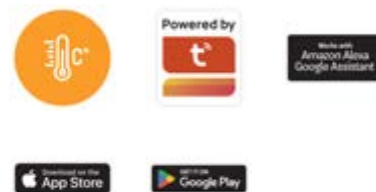

thermometer design: wireless – smart = indoor temperature: -20 °C to +60 °C, resolution 0.1 °C = indoor humidity: 0 % to 99 % RH, resolution 1 % = temperature warning = the possibility of hanging on the wall = power of station: 1× 3 V CR2032 (included) = main unit size: 26 × 13 × 52 mm



 **EGS0102** 1/-/-/80  
26 03 122 000 EGS0102



thermometer design: wireless – smart = clock: wifi = LED backlight display = date = indoor temperature: -10 °C to +60 °C, resolution 0.1 °C = indoor humidity: 0 % to 99 % RH, resolution 1 % = min. and max. temperature = temperature warning = the possibility of hanging on the wall = power of station: 3× 1.5 V AAA (not included) = main unit size: 56 × 23 × 56 mm = screen size: 42 × 40 mm



 **EGS0101** 1/-/-/80  
26 03 123 000 EGS0101



## Spare sensors

- wireless sensors and wired probes for EMOS weather stations
- measure outdoor temperature and humidity (-50 to +70 °C)
- range of up to 25–100 m in an open area

designed for the type of main unit: AOK-5018B, AOK-5060, S627BS, IB303TR, E0107T, IW001-DCF, IW003-DCF, E5068, E5062, E5063, E3078, E3028, E0300, E8236, E0211, E3010, E0127, E0329, E5005, E3003, E0107, E0129, E5101, E5010, E0352, E5059, E5111, E8636, E0316 = indicator of outdoor humidity: 20 % to 95 % RH, resolution 1 % = range in open space: up to 25 m = external wire sensor = operating temperature: -50 °C to +70 °C, resolution 0.1 °C = power source: 2× 1.5 V AAA (not included) = dimensions: 21 × 60 × 100 mm



 **E05018** 1/-/-/100  
26 93 000 120 AOK2011



designed for the type of main unit: E3070 = range in open space: up to 30 m = operating temperature: -30 °C to +60 °C, resolution 0.1 °C = power source: 2× 1.5 V AAA (not included) = dimensions: 84 × 64 × 25 mm



**E3070** 1/-/-/100  
26 93 000 180 E03070

designed for the type of main unit: C8403D, C8404C, C8405D, E8468, E8466 = indicator of outdoor humidity: 20 % to 90 % RH, resolution 1 % = range in open space: up to 50 m = operating temperature: -40 °C to +70 °C, resolution 0.1 °C = power source: 2× 1.5 V AA (not included) = dimensions: 64 × 100 × 35 mm



**E08400** 1/-/-/50  
26 93 000 160 C8340C

designed for the type of main unit: E6018, E6016 = indicator of outdoor humidity: 1 % to 99 % RH, resolution 1 % = range in open space: up to 100 m = operating temperature: -50 °C to +70 °C, resolution 0.1 °C = power source: 2× 1.5 V AAA (not included) = dimensions: 15 × 62 × 100 mm



**E6018** 1/-/-/100  
26 93 000 220 E06018

designed for the type of main unit: E6016 = indicator of outdoor humidity: 1 % to 99 % RH, resolution 1 % = range in open space: up to 100 m = operating temperature: -30 °C to +60 °C, resolution 0.1 °C = power source: 4× 1.5 V AA (not included) = dimensions: 275 × 135 × 310 mm



**E6016** 1/-/-/1  
26 93 000 230 E06016

designed for the type of main unit: E0387 = indicator of outdoor humidity: 1 % to 99 % RH, resolution 1 % = range in open space: up to 80 m = operating temperature: -40 °C to +60 °C, resolution 0.1 °C = power source: 2× 1.5 V AA (not included) = dimensions: 20 × 38 × 100 mm



**E00387** 1/-/-/100  
26 93 000 240 E00387



## Kitchen, hanging scales

- digital kitchen scales with load capacity of up to 5–15 kg
- ability to switch between units (g, kg, ml, lb, oz)
- with and without backlit screen
- powered by AAA or button batteries (CR2032)
- battery-free scales – turning wheel charges up for 2 minutes
- ABS plastic, toughened glass or stainless surface
- with tare and overload function
- digital hanging scales, 50 kg capacity (for fish or luggage)

- scale surface: tempered glass
- tare function
- maximum load: 5 kg
- weight units: g, oz, lb, kg
- power source: 1× 3 V CR2032 (included)
- dimensions: 15 × 152 × 219 mm

**EV014**

1/-/-/20

26 17 001 400

TY3101

- scale surface: tempered glass
- tare function
- maximum load: 5 kg
- weight units: g, oz, lb, kg
- power source: 1× 3 V CR2032 (included)
- dimensions: 15 × 152 × 219 mm

**EV014B**

1/-/-/20

26 17 001 401

TY3101B

- backlight display
- scale surface: ABS plastic
- tare function
- maximum load: 5 kg
- weight units: g, oz, lb, kg, ml
- power source: 2× 1.5 V AAA (not included)
- dimensions: 20 × 198 × 223 mm

**EV025**

1/-/-/6

26 17 002 500

EV025

- backlight display
- scale surface: ABS plastic
- tare function
- maximum load: 5 kg
- weight units: g, kg, lb, oz
- power source: 2× 1.5 V AAA (not included)
- dimensions: 49 × 150 × 218 mm

**EV016**

1/-/-/6

26 17 001 600

GP-KS021

- backlight display
- scale surface: tempered glass
- tare function
- maximum load: 15 kg
- weight units: g, kg, lb, oz
- power source: 2× 1.5 V AAA (included)
- dimensions: 22 × 180 × 210 mm



**EV022**  
26 17 002 200

1/-/-/12  
EV022

- backlight display
- scale surface: stainless steel
- tare function
- maximum load: 5 kg
- weight units: g, oz, lb, kg
- power source: 2× 3 V CR2032 (included)
- dimensions: 15 × 163 × 221 mm



**EV012**  
26 17 001 200

1/-/-/12  
PT-836

- backlight display
- scale surface: stainless steel
- tare function
- maximum load: 15 kg
- weight units: g, kg, lb, oz
- power source: 2× 1.5 V AAA (not included)
- dimensions: 15 × 176 × 216 mm



**EV023**  
26 17 002 300

1/-/-/20  
EV023

- backlight display
- scale surface: stainless steel
- tare function
- maximum load: 10 kg
- weight units: g, kg, ml, oz, lb, tl
- power source: 2× 1.5 V AAA (included)
- dimensions: 15 × 153 × 212 mm



**EV026**  
26 17 000 500

1/-/-/20  
EV026

- scale surface: ABS plastic + aluminium (Al)
- tare function
- maximum load: 50 kg
- weight units: kg, lb
- power source: 1× 3 V CR2032 (included)
- dimensions: 31 × 40 × 148 mm



**EV020**  
26 17 002 000

1/-/-/40  
EV020

- backlight display
- scale surface: ABS plastic + stainless steel
- tare function
- maximum load: 3 kg
- weight units: g, lb, oz
- power source: 3× 1.5 V AAA (included)
- dimensions: 154 × 28 × 190 mm



**EV029**  
26 17 002 600

1/-/-/10  
EV029

- scale surface: ABS plastic
- tare function
- maximum load: 5 kg
- weight units: g, oz, lb:oz, ml, fl:oz
- power source: 1× 3 V CR2032 (included)
- dimensions: 15 × 176 × 216 mm



**EV028**  
26 17 002 800

1/-/-/40  
EV028

## Kitchen timers

- serves as a timer (countdown) and stopwatch (counts from 0)
- triggers audio alert once time limit expires
- selected models even allow 2 counts at the same time
- fitted with magnet for mounting on a fridge/adjustable stand
- draws power from AAA or button battery

- countdown of time max. from: 99 min. 59 sec.
- stopwatch
- memory of the last value
- magnet for fixing
- power source: 1× 1.5 V LR1130 (included)
- dimensions: 7 × 55 × 70 mm
- packaging: 1 pc, blister



**E0202**  
26 05 004 000

1/-/10/100  
TP202

- thermometer design: wire
- stopwatch
- magnet for fixing
- countdown of time max. from: 99 min. 59 sec.
- memory of the last value
- outdoor temperature: -20 °C to +250 °C, res. 1 °C
- temperature warning
- wired probe for sensor: 1.4 m
- the possibility of hanging on the wall
- power of station: 1× 1.5 V AAA (not included)
- main unit size: 18 × 65 × 70 mm
- screen size: 47 × 21 mm



**E2157**  
26 03 015 000

1/-/10/40  
E2157

## Personal scales

- modern look complements a bathroom and helps you keep fit
- ensures healthy weight loss by measuring fat, water & muscle
- memory for 10–13 people (stores height, weight, age and sex)
- draws power from AAA or button batteries (CR2032)
- toughened glass can carry 150–180 kg (depending on model)

- backlight display
- scale surface: tempered glass
- maximum load: 150 kg
- BMI – measurement of fat, water and muscle
- weight units: kg, lb, St
- memory: 10 persons max.
- power source: 2× 1.5 V AAA (included)
- dimensions: 20 × 330 × 320 mm

**EV104**

1/-/-/6

26 17 010 400

PT-718

- backlight display
- scale surface: tempered glass
- maximum load: 180 kg
- weight units: kg, lb, St
- power source: 2× 1.5 V AAA (included)
- dimensions: 25 × 280 × 280 mm

**EV106**

1/-/-/5

26 17 010 600

EV106

- scale surface: tempered glass
- maximum load: 180 kg
- weight units: kg, lb, St
- power source: 1× 3 V CR2032 (included)
- dimensions: 20 × 300 × 300 mm

**EV105**

1/-/-/6

26 17 010 500

TY6108

## Air quality GoSmart



- Overview of the CO2 level in the monitored room
- Display of indoor temperature, humidity and hours
- LED display with permanent backlight
- Colour animation of air quality
- Built-in alarm for elevated CO2 concentration
- Connection to home network via WIFI protocol
- Compatibility with EMOS GoSmart products and TUYA devices



- option to set the temperature unit: °C/°F
- CO2 alert
- setting CO2 alert limits
- CO2 level indicator
- CO2 measurement range: 400 to 5 000 PPM
- indoor temperature: 0 °C to +50 °C, resolution 0.1°C
- indoor humidity: 20 % to 90 % RH, resolution 1 %
- supported OS: Android, iOS
- compatibility: EMOS GoSmart, TUYA, LIDL, Smartlife
- protocol: Wi-Fi
- transmission frequency: 2.4 GHz Wi-Fi
- notifications to the mobile app
- application languages: EN, CZ, SK, PL, DE, HU, SI, FR,



**E30300** 1/-/-/12  
26 27 303 000 E30300

## Bathroom scales GoSmart



- Wide range of measuring indicators
- Clear reports in graphical form
- Memory for several users
- Elegant design
- Weighing accuracy to 100 g, max. load capacity 180 kg
- Connection to home network via Bluetooth
- Compatibility with EMOS GoSmart products and TUYA devices

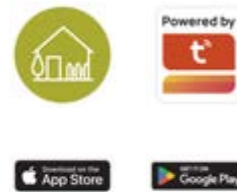

- backlight display
- scale surface: ITO tempered glass
- maximum load: 180 kg
- Bluetooth
- BMI – measurement of fat, water and muscle
- weight units: kg, lb
- memory: 10 persons max.
- power source: 3× 1.5 V AAA (included)
- dimensions: 26 × 300 × 300 mm
- supported OS: Android, iOS
- compatibility: EMOS GoSmart, TUYA, LIDL, Smartlife,
- protocol: Wi-Fi
- transmission frequency: 2.4 GHz Wi-Fi
- notifications to the mobile app
- application languages: EN, CZ, SK, PL, DE, HU, SI, FR,



**EV112** 1/-/-/3  
26 17 010 902 EV112



# TV and audio accessories



## Multimedia players, radios

- wirelessly connects to Bluetooth devices (phone, tablet...)
- crystal clear sound, long battery run time and USB charging
- selected models also have a micro SD card slot or radio port
- can be used as handsfree (in car, kitchen) due to microphone
- also, portable FM radios with slot for SD card and USB

tuner frequency: FM 88-108 MHz = USB input = slot for microSD card = MP3 support = headphone output = power supply: 5 V/USB-C (not included) = antenna: telescopic antenna = speaker: 50 mm/4 Ohm/3 W = dimensions: 125 × 30 × 70 mm = packaging: 1 pc, box



**E0086**

1/-/-/32

26 18 002 600

EM-213

## TV wall mounts

- fixed, tilting and bracket mounts for TVs of various sizes
- meet strictest rigidity, load and variability requirements
- in various sizes, load capacity up to 95 kg
- installation material for standard wall types included

holder type: tilting = acceptable screen diagonals: 32-90" (81-229 cm) = min. VESA mounting dimensions: 200 × 200 mm = max. VESA mounting dimensions: 600 × 400 mm = tilt: -10° = distance from a wall: 37 mm = max. load capacity (kg): 60 = dimensions: 20 × 650 × 140 mm = packaging: 1 pc, paper box



**KT2265**

1/-/-/6

32 32 226 500

BETA 600X



holder type: tilting = acceptable screen diagonals: 29–65" (74–165 cm) = min. VESA mounting dimensions: 200 × 200 mm = max. VESA mounting dimensions: 400 × 400 mm = tilt: -10° = distance from a wall: 25 mm = max. load capacity (kg): 50 = dimensions: 20 × 470 × 220 mm = packaging: 1 pc, paper box



**KT2244**  
32 32 224 400

1/-/-5  
BETA 400

holder type: console = acceptable screen diagonals: 32–80" (81–203 cm) = min. VESA mounting dimensions: 200 × 200 mm = max. VESA mounting dimensions: 600 × 400 mm = tilt: +/-15° = positioning: +/- 90° = distance from a wall: 76–510 mm = max. load capacity (kg): 60 = dimensions: 510 × 650 × 204 mm = packaging: 1 pc, paper box



**KT3564**  
32 32 356 400

1/-/-2  
GAMMA 600  
ULTRA X

holder type: console = acceptable screen diagonals: 32–80" (81–203 cm) = min. VESA mounting dimensions: 200 × 200 mm = max. VESA mounting dimensions: 600 × 400 mm = tilt: -15° = positioning: 180° = distance from a wall: 59–635 mm = max. load capacity (kg): 50 = dimensions: 630 × 80 × 300 mm = packaging: 1 pc, paper box



**KT3364**  
32 32 336 400

1/-/-2  
GAMMA LED 600

holder type: console = acceptable screen diagonals: 10–39" (25–99 cm) = min. VESA mounting dimensions: 75 × 75 mm = max. VESA mounting dimensions: 200 × 200 mm = tilt: 10°/-15° = positioning: 180° = distance from a wall: 102–340 mm = max. load capacity (kg): 30 = dimensions: 355 × 90 × 180 mm = packaging: 1 pc, paper box

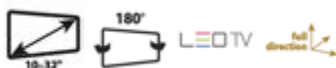

**KT3223**  
32 32 322 300

1/-/-8  
GAMMA 200  
ULTRA X

## Universal remote controllers OFA

- 100 % guaranteed compatibility with your devices
- controller pairs with most devices due to vast code database
- quality material manufacturing
- service support: +420 581 261 101/e-mail: oneforall@emos.cz

possible number of controlled devices: 3 = designed for: TV, DVB-T, SAT, KAB TV, IPTV, Amplifier, Tuner, Home cinema, Sound Bar = code search: manual = simple set settings = learning function = code remembered after removing the battery = range: 15 m = power source: 2× AAA = model line: Zapper = dimensions: 20 × 48 × 174 mm = weight: 80 g = packaging: 1 pc, blister



8 716184 059933

**KE6820**

32 33 068 200

1/-/3/24

URC6820

possible number of controlled devices: 8 = designed for: TV, DVB-T, SAT, KAB TV, IPTV, DVD, Blu-ray, Video, Amplifier, Tuner, Home cinema, CD, iPod Dock = code search: manual = code remembered after removing the battery = range: 15 m = power source: 2× AAA = model line: Basic = dimensions: 24 × 50 × 182 mm = weight: 80 g = packaging: 1 pc, blister



8 716184 045080

**KE2981**

32 33 029 810

1/-/6/48

URC2981

possible number of controlled devices: 8 = designed for: TV, DVB-T, SAT, KAB TV, IPTV, DVD, Blu-ray, Video, Amplifier, Tuner, Home cinema, CD, iPod Dock = code search: manual = learning function = code remembered after removing the battery = range: 15 m = power source: 2× AAA = model line: Contour = dimensions: 22.3 × 4.4 × 2.0 cm = weight: 84 g = packaging: 1 pc, blister



8 716184 065040

**KE1280**

32 33 012 800

1/-/6/48

URC1280

possible number of controlled devices: 4 = designed for: TV, DVB-T, SAT, KAB TV, IPTV, DVD, Blu-ray, Video = code search: manual = learning function = code remembered after removing the battery = range: 15 m = power source: 2× AAA = model line: Contour = dimensions: 22.3 × 4.4 × 2.0 cm = weight: 84 g = packaging: 1 pc, blister



8 716184 065019

**KE1240**

32 33 012 400

1/-/6/48

URC1240

possible number of controlled devices: 1 = designed for: TV = code search: manual = learning function = code remembered after removing the battery = range: 15 m = power source: 2× AAA = model line: Contour = dimensions: 22.3 × 4.4 × 2.0 cm = weight: 84 g = packaging: 1 pc, blister



**KE1210**  
32 33 012 100

1/-/6/48  
URC1210

possible number of controlled devices: 1 = designed for: TV Hisense = code search: readjustment of the code for a particular HISENSE line = learning function = code remembered after removing the battery = range: 15 m = power source: 2× AAA = model line: special TV = dimensions: 24 × 51 × 205 mm = weight: 90 g = packaging: 1 pc, small paper box



**KE1916**  
32 33 019 160

1/-/3/24  
KE1916

possible number of controlled devices: 2 = designed for: Samsung TV and audio device = code search: readjustment of the code for a particular SAMSUNG line = simple set settings: yes – for audio device = learning function = code remembered after removing the battery = range: 15 m = power source: 2× AAA = macro device mode re-assignment = model line: special TV = dimensions: 23 × 44 × 195 mm = weight: 90 g = packaging: 1 pc, small paper box



**KE4910**  
32 33 049 100

1/-/3/24  
URC 4910

possible number of controlled devices: 2 = designed for: TV LG and audio device = code search: readjustment of the code for a particular LG line = simple set settings: yes – for audio device = learning function = code remembered after removing the battery = range: 15 m = power source: 2× AAA = macro device mode re-assignment = model line: special TV = dimensions: 25 × 44 × 195 mm = weight: 90 g = packaging: 1 pc, small paper box



**KE4911**  
32 33 049 110

1/-/3/24  
URC 4911

possible number of controlled devices: 2 = designed for: Sony TV and audio device = code search: readjustment of the code for a particular SONY line = simple set settings: yes – for audio device = learning function = code remembered after removing the battery = range: 15 m = power source: 2× AA = macro device mode re-assignment = model line: special TV = dimensions: 28 × 47 × 224 mm = weight: 88 g = packaging: 1 pc, small paper box



**KE4912**  
32 33 049 120

1/-/3/24  
URC 4912



www.emos.eu

Order Code  
Item Number

Packaging  
Type

possible number of controlled devices: 2 = designed for: Philips TV and audio device = code search: readjustment of the code for a particular Philips line = simple set settings: yes – for audio device = learning function = code remembered after removing the battery = range: 15 m = power source: 2× AAA = macro device mode re-assignment = model line: special TV = dimensions: 22 × 47 × 207 mm = weight: 90 g = packaging: 1 pc, small paper box



8 716184 072727

**KE4913**

32 33 049 130

1/-/3/24

URC 4913

possible number of controlled devices: 2 = designed for: Panasonic TV and audio device = code search: readjustment of the code for a particular PANASONIC line = simple set settings: yes – for audio device = learning function = code remembered after removing the battery = range: 15 m = power source: 2× AA = macro device mode re-assignment = model line: special TV = dimensions: 28 × 47 × 224 mm = weight: 90 g = packaging: 1 pc, small paper box



8 716184 072758

**KE4914**

32 33 049 140

1/-/3/24

URC 4914

possible number of controlled devices: 5 = designed for: TV, DVB-T, SAT, KAB TV, IPTV, DVD, Blu-ray, Amplifier, Tuner, Home Cinema, CD, iPod Dock = code search: automatic = simple set settings = learning function = code remembered after removing the battery = range: 15 m = power source: 4× AAA = macro device mode re-assignment = model line: Smart Control 5 = dimensions: 22.2 × 4.3 × 1.8 cm = weight: 100 g = packaging: 1 pc, small paper box



8 716184 073113

**KE7955N**

32 33 079 551

1/-/3/12

KE7955N



# Power supply extension cords, cable reels, plugs, accessories







## Power supply extension cords and sockets

### FRENCH

### Single socket extension cords

### Two-cores PVC

- extension cable with one socket
- length: 3 or 20 m, PVC insulation – ideal for the interior
- conductor: 0.75 mm<sup>2</sup> or 1 mm<sup>2</sup>, child socket covers

<b>P01303</b>	1/-/10/30	
19 02 010 300	P01303	
	 	
<ul style="list-style-type: none"> <li>▪ length: 3 m</li> <li>▪ number of sockets: 1</li> <li>▪ maximum load: 575 W</li> <li>▪ conductor cross section: 0.75 mm<sup>2</sup></li> <li>▪ conductor: H03VVH2-F</li> <li>▪ type of insulation: PVC</li> </ul>	<ul style="list-style-type: none"> <li>▪ children protection</li> <li>▪ packaging: 1 pc, hanging</li> </ul>	

<b>P01320R</b>	1/-/-/4	
19 01 012 016	P01320R, P01320RH	
	 	
<ul style="list-style-type: none"> <li>▪ length: 20 m</li> <li>▪ conductor cross section: 1.5 mm<sup>2</sup></li> <li>▪ voltage: 230 V</li> <li>▪ current: 16 A</li> <li>▪ IP rating: IP20</li> <li>▪ number of sockets: 1</li> </ul>	<ul style="list-style-type: none"> <li>▪ thermal fuse: no</li> <li>▪ conductor: H05VV-F2</li> <li>▪ max. unreeled load: 16 A max./3 680 W</li> <li>▪ children protection</li> <li>▪ packaging: 1 pc, shrink</li> </ul>	





# Power supply extension cords and sockets





## SCHUKO





## MOES Extension cords

### 1-phase 16A with rubber insulation

- neoprene extension cord – resists water (IP44) and heat
- conductor: 1.5 mm<sup>2</sup>, length 3–10 m, max. load: 3 680 W
- backlit switch with rubber cover
- 4 round sockets, child socket covers
- openings in socket panel body for mounting onto a wall etc.





<b>P14231</b>	1/-/-/10	
19 22 140 302	E-K-4E	
		
<ul style="list-style-type: none"> <li>▪ length: 3 m</li> <li>▪ number of sockets: 4× 2P + PE SCHUKO</li> <li>▪ voltage/current: 250 V~/16 A max.</li> <li>▪ maximum load: 3 680 W</li> <li>▪ type of insulation: rubber/neopren</li> <li>▪ conductor: H07RN-F3G 1.5 mm<sup>2</sup></li> </ul>		
<ul style="list-style-type: none"> <li>▪ material of the sockets + plugs: plastic /</li> <li>▪ packaging: 1 pc, foil</li> </ul>		

<b>P14251</b>	1/-/-/6	
19 22 340 501	E-K-4E	
		
<ul style="list-style-type: none"> <li>▪ length: 5 m</li> <li>▪ number of sockets: 4× 2P + PE SCHUKO</li> <li>▪ voltage/current: 250 V~/16 A max.</li> <li>▪ maximum load: 3 680 W</li> <li>▪ type of insulation: rubber/neopren</li> <li>▪ conductor: H07RN-F3G 1.5 mm<sup>2</sup></li> </ul>		
<ul style="list-style-type: none"> <li>▪ material of the sockets + plugs: plastic /</li> <li>▪ packaging: 1 pc, foil</li> </ul>		





<b>P14201</b>	1/-/-/6	
19 22 341 000	E-K-4E	
		
<ul style="list-style-type: none"> <li>▪ length: 10 m</li> <li>▪ number of sockets: 4× 2P + PE SCHUKO</li> <li>▪ voltage/current: 250 V~/16 A max.</li> <li>▪ maximum load: 3 680 W</li> <li>▪ type of insulation: rubber/neopren</li> <li>▪ conductor: H07RN-F3G 1.5 mm<sup>2</sup></li> </ul>		
<ul style="list-style-type: none"> <li>▪ material of the sockets + plugs: plastic /</li> <li>▪ packaging: 1 pc, foil</li> </ul>		

# 1-phase 16A with PVC insulation





- extension cables with PVC insulation are ideal for household
- conductor: 1.5 mm<sup>2</sup> (1.0 mm<sup>2</sup> up to 2 m) round sockets
- round sockets, with or without switch
- various lengths, max. load: 3 680 W, child socket covers
- in white – to blend discreetly into the interior

<b>P0321R</b>	1/5/-/20	
19 22 030 153	SE0311-1,5	
	 	
8 592920 052662		





- length: 1.5 m
- number of sockets: 3× 2P + PE SCHUKO
- voltage/current: 250 V~/16 A max.
- maximum load: 3 680 W
- type of insulation: PVC
- conductor: H05VV-F3G 1.5 mm<sup>2</sup>
- material of the sockets + plugs: plastic
- packaging: 1 pc, hanging

<b>P0323R</b>	1/5/-/20	
19 22 030 308	SE0313-1,5	
	 	
8 592920 016336		





- length: 3 m
- number of sockets: 3× 2P + PE SCHUKO
- voltage/current: 250 V~/16 A max.
- maximum load: 3 680 W
- type of insulation: PVC
- conductor: H05VV-F3G 1.5 mm<sup>2</sup>
- material of the sockets + plugs: plastic
- packaging: 1 pc, hanging

<b>P0325R</b>	1/5/-/15	
19 22 030 508	SE0315-1,5	
	 	
8 592920 016343		





- length: 5 m
- number of sockets: 3× 2P + PE SCHUKO
- voltage/current: 250 V~/16 A max.
- maximum load: 3 680 W
- type of insulation: PVC
- conductor: H05VV-F3G 1.5 mm<sup>2</sup>
- material of the sockets + plugs: plastic
- packaging: 1 pc, hanging

<b>P0421R</b>	1/5/-/20	
19 22 040 152	SE0411-1,5	
	 	
8 592920 052679		





- length: 1.5 m
- number of sockets: 4× 2P + PE SCHUKO
- voltage/current: 250 V~/16 A max.
- maximum load: 3 680 W
- type of insulation: PVC
- conductor: H05VV-F3G 1.5 mm<sup>2</sup>
- material of the sockets + plugs: plastic
- packaging: 1 pc, hanging

<b>P0423R</b>	1/5/-/20	
19 22 040 302	SE0413-1,5	
	 	
8 592920 052747		





- length: 3 m
- number of sockets: 4× 2P + PE SCHUKO
- voltage/current: 250 V~/16 A max.
- maximum load: 3 680 W
- type of insulation: PVC
- conductor: H05VV-F3G 1.5 mm<sup>2</sup>
- material of the sockets + plugs: plastic
- packaging: 1 pc, hanging

<b>P0425R</b>	1/5/-/15	
19 22 040 502	SE0415-1,5 (SEH0415-1.5)	
	 	
8 592920 064429		

- length: 5 m
- number of sockets: 4× 2P + PE SCHUKO
- voltage/current: 250 V~/16 A max.
- maximum load: 3 680 W
- type of insulation: PVC
- conductor: H05VV-F3G 1.5 mm<sup>2</sup>
- material of the sockets + plugs: plastic
- packaging: 1 pc, hanging

<b>P0521R</b>	1/5/-/15	
19 22 050 153	SE0511-1,5	
	 	
8 592920 052686		

- length: 1.5 m
- number of sockets: 5× 2P + PE SCHUKO
- voltage/current: 250 V~/16 A max.
- maximum load: 3 680 W
- type of insulation: PVC
- conductor: H05VV-F3G 1.5 mm<sup>2</sup>
- material of the sockets + plugs: plastic
- packaging: 1 pc, hanging

<b>P0523R</b>	1/-/-/15	
19 22 050 308	SE0513-1,5	
	 	
8 592920 016374		

- length: 3 m
- number of sockets: 5× 2P + PE SCHUKO
- voltage/current: 250 V~/16 A max.
- maximum load: 3 680 W
- type of insulation: PVC
- conductor: H05VV-F3G 1.5 mm<sup>2</sup>
- material of the sockets + plugs: plastic
- packaging: 1 pc, hanging



www.emos.eu

Order Code  
Item Number

Packaging  
Type

**P0525R** 1/-/-/10  
19 22 050 508  
SE0515-1,5  
(SEH0515-1.5)

- length: 5 m
- number of sockets: 5× 2P + PE SCHUKO
- voltage/current: 250 V~/16 A max.
- maximum load: 3 680 W
- type of insulation: PVC
- conductor: H05VV-F3G 1.5 mm<sup>2</sup>
- material of the sockets + plugs: plastic
- packaging: 1 pc, hanging

**P0623R** 1/-/-/10  
19 22 060 302  
SE0613-1,5

- length: 3 m
- number of sockets: 6× 2P + PE SCHUKO
- voltage/current: 250 V~/16 A max.
- maximum load: 3 680 W
- type of insulation: PVC
- conductor: H05VV-F3G 1.5 mm<sup>2</sup>
- material of the sockets + plugs: plastic
- packaging: 1 pc, hanging

**P0625R** 1/-/-/10  
19 22 060 502  
SE0615-1,5

- length: 5 m
- number of sockets: 6× 2P + PE SCHUKO
- voltage/current: 250 V~/16 A max.
- maximum load: 3 680 W
- type of insulation: PVC
- conductor: H05VV-F3G 1.5 mm<sup>2</sup>
- material of the sockets + plugs: plastic
- packaging: 1 pc, hanging

**P1321R** 1/-/-/15  
19 22 130 156  
SE1311-1,5

- length: 1.5 m
- number of sockets: 3× 2P + PE SCHUKO
- voltage/current: 250 V~/16 A max.
- maximum load: 3 680 W
- type of insulation: PVC
- conductor: H05VV-F3G 1.5 mm<sup>2</sup>
- material of the sockets + plugs: plastic
- packaging: 1 pc, hanging

**P1323R** 1/5/-/20  
19 22 130 308  
SE1313-1,5  
(SEH1313-1.5)

- length: 3 m
- number of sockets: 3× 2P + PE SCHUKO
- voltage/current: 250 V~/16 A max.
- maximum load: 3 680 W
- type of insulation: PVC
- conductor: H05VV-F3G 1.5 mm<sup>2</sup>
- material of the sockets + plugs: plastic
- packaging: 1 pc, hanging

**P1325R** 1/-/-/10  
19 22 130 508  
SE1315-1,5  
(SEH1315-1.5)

- length: 5 m
- number of sockets: 3× 2P + PE SCHUKO
- voltage/current: 250 V~/16 A max.
- maximum load: 3 680 W
- type of insulation: PVC
- conductor: H05VV-F3G 1.5 mm<sup>2</sup>
- material of the sockets + plugs: plastic
- packaging: 1 pc, hanging

**P1421R** 1/-/-/15  
19 22 140 152  
SE1411-1,5

- length: 1.5 m
- number of sockets: 4× 2P + PE SCHUKO
- voltage/current: 250 V~/16 A max.
- maximum load: 3 680 W
- type of insulation: PVC
- conductor: H05VV-F3G 1.5 mm<sup>2</sup>
- material of the sockets + plugs: plastic
- packaging: 1 pc, hanging

**P1423R** 1/-/-/10  
19 22 140 303  
SE1413-1,5  
(SEH1413-1.5)

- length: 3 m
- number of sockets: 4× 2P + PE SCHUKO
- voltage/current: 250 V~/16 A max.
- maximum load: 3 680 W
- type of insulation: PVC
- conductor: H05VV-F3G 1.5 mm<sup>2</sup>
- material of the sockets + plugs: plastic
- packaging: 1 pc, hanging

**P1425R** 1/5/-/15  
19 22 140 503  
SE1415-1,5  
(SEH1415-1.5)

- length: 5 m
- number of sockets: 4× 2P + PE SCHUKO
- voltage/current: 250 V~/16 A max.
- maximum load: 3 680 W
- type of insulation: PVC
- conductor: H05VV-F3G 1.5 mm<sup>2</sup>
- material of the sockets + plugs: plastic
- packaging: 1 pc, hanging

**P1521R** 1/-/-/15  
19 22 150 154  
SE1511-1,5

- length: 1.5 m
- number of sockets: 5× 2P + PE SCHUKO
- voltage/current: 250 V~/16 A max.
- maximum load: 3 680 W
- type of insulation: PVC
- conductor: H05VV-F3G 1.5 mm<sup>2</sup>
- material of the sockets + plugs: plastic
- packaging: 1 pc, hanging



www.emos.eu

Order Code  
Item Number

Packaging  
Type

**P1523R** 1/-/-/10  
19 22 150 308  
SE1513-1,5 (SEH1513-1.5)

- length: 3 m
- number of sockets: 5× 2P + PE SCHUKO
- voltage/current: 250 V~/16 A max.
- maximum load: 3 680 W
- type of insulation: PVC
- conductor: H05VV-F3G 1.5 mm<sup>2</sup>
- material of the sockets + plugs: plastic
- packaging: 1 pc, hanging

**P1525R** 1/-/-/10  
19 22 150 508  
SE1515-1,5 (SEH1515-1.5)

- length: 5 m
- number of sockets: 5× 2P + PE SCHUKO
- voltage/current: 250 V~/16 A max.
- maximum load: 3 680 W
- type of insulation: PVC
- conductor: H05VV-F3G 1.5 mm<sup>2</sup>
- material of the sockets + plugs: plastic
- packaging: 1 pc, hanging

**P1621R** 1/-/-/15  
19 22 160 152  
SE1611-1,5

- length: 1.5 m
- number of sockets: 6× 2P + PE SCHUKO
- voltage/current: 250 V~/16 A max.
- maximum load: 3 680 W
- type of insulation: PVC
- conductor: H05VV-F3G 1.5 mm<sup>2</sup>
- material of the sockets + plugs: plastic
- packaging: 1 pc, hanging

**P1623R** 1/-/-/10  
19 22 160 302  
SE1613-1,5

- length: 3 m
- number of sockets: 6× 2P + PE SCHUKO
- voltage/current: 250 V~/16 A max.
- maximum load: 3 680 W
- type of insulation: PVC
- conductor: H05VV-F3G 1.5 mm<sup>2</sup>
- material of the sockets + plugs: plastic
- packaging: 1 pc, hanging

**P1625R** 1/-/-/10  
19 22 160 502  
SE1615-1,5 (SEH1615-1.5)

- length: 5 m
- number of sockets: 6× 2P + PE SCHUKO
- voltage/current: 250 V~/16 A max.
- maximum load: 3 680 W
- type of insulation: PVC
- conductor: H05VV-F3G 1.5 mm<sup>2</sup>
- material of the sockets + plugs: plastic
- packaging: 1 pc, hanging

**P1523RU** 1/-/-/10  
19 22 150 304  
P1523RU

- length: 3 m
- number of sockets: 5× 2P + PE SCHUKO
- voltage/current: 250 V~/16 A max.
- maximum load: 3 680 W
- type of insulation: PVC
- conductor: H05VV-F3G 1.5 mm<sup>2</sup>
- material of the sockets + plugs: plastic
- packaging: 1 pc, hanging

**PC1321R** 1/-/-/15  
19 22 330 152  
SE1311-1,5

- length: 1.5 m
- number of sockets: 3× 2P + PE SCHUKO
- voltage/current: 250 V~/16 A max.
- maximum load: 3 680 W
- type of insulation: PVC
- conductor: H05VV-F3G 1.5 mm<sup>2</sup>
- material of the sockets + plugs: plastic
- packaging: 1 pc, hanging

**PC1421R** 1/-/-/15  
19 22 340 151  
SE1411-1,5

- length: 1.5 m
- number of sockets: 4× 2P + PE SCHUKO
- voltage/current: 250 V~/16 A max.
- maximum load: 3 680 W
- type of insulation: PVC
- conductor: H05VV-F3G 1.5 mm<sup>2</sup>
- material of the sockets + plugs: plastic
- packaging: 1 pc, hanging

**PC1423R** 1/-/-/10  
19 22 340 301  
SE1413-1,5

- length: 3 m
- number of sockets: 4× 2P + PE SCHUKO
- voltage/current: 250 V~/16 A max.
- maximum load: 3 680 W
- type of insulation: PVC
- conductor: H05VV-F3G 1.5 mm<sup>2</sup>
- material of the sockets + plugs: plastic
- packaging: 1 pc, hanging

**PC1425R** 1/-/-/15  
19 22 340 502  
SE1415-1,5

- length: 5 m
- number of sockets: 4× 2P + PE SCHUKO
- voltage/current: 250 V~/16 A max.
- maximum load: 3 680 W
- type of insulation: PVC
- conductor: H05VV-F3G 1.5 mm<sup>2</sup>
- material of the sockets + plugs: plastic
- packaging: 1 pc, hanging





www.emos.eu

Order Code  
Item Number

Packaging  
Type

**PC1521R** 1/-/-15  
19 22 350 151 SE1511-1,5





- length: 1.5 m
- number of sockets: 5× 2P + PE SCHUKO
- voltage/current: 250 V~/16 A max.
- maximum load: 3 680 W
- type of insulation: PVC
- conductor: H05VV-F3G 1.5 mm<sup>2</sup>
- material of the sockets + plugs: plastic
- packaging: 1 pc, hanging



**PC1621R** 1/-/-15  
19 22 360 150 SE1611-1,5







- length: 1.5 m
- number of sockets: 6× 2P + PE SCHUKO
- voltage/current: 250 V~/16 A max.
- maximum load: 3 680 W
- type of insulation: PVC
- conductor: H05VV-F3G 1.5 mm<sup>2</sup>
- material of the sockets + plugs: plastic
- packaging: 1 pc, hanging

**P0321** 1/5/-/20  
19 22 030 150 SE0311



- length: 1.5 m
- number of sockets: 3× 2P + PE SCHUKO
- voltage/current: 250 V~/16 A max.
- maximum load: 3 680 W
- type of insulation: PVC
- conductor: H05VV-F3G 1 mm<sup>2</sup>
- material of the sockets + plugs: plastic
- packaging: 1 pc, hanging

**P0322** 1/5/-/20  
19 22 030 200 SE0312



- length: 2 m
- number of sockets: 3× 2P + PE SCHUKO
- voltage/current: 250 V~/16 A max.
- maximum load: 3 680 W
- type of insulation: PVC
- conductor: H05VV-F3G 1 mm<sup>2</sup>
- material of the sockets + plugs: plastic
- packaging: 1 pc, hanging

**P0421** 1/5/-/20  
19 22 040 150 SE0411



- length: 1.5 m
- number of sockets: 4× 2P + PE SCHUKO
- voltage/current: 250 V~/16 A max.
- maximum load: 3 680 W
- type of insulation: PVC
- conductor: H05VV-F3G 1 mm<sup>2</sup>
- material of the sockets + plugs: plastic
- packaging: 1 pc, hanging

**P0521** 1/5/-/15  
19 22 050 150 SE0511



- length: 1.5 m
- number of sockets: 5× 2P + PE SCHUKO
- voltage/current: 250 V~/16 A max.
- maximum load: 2 300 W
- type of insulation: PVC
- conductor: H05VV-F3G 1.0 mm<sup>2</sup>
- material of the sockets + plugs: plastic
- packaging: 1 pc, hanging

**P0622** 1/5/-/15  
19 22 060 200 SE0612



- length: 2 m
- number of sockets: 6× 2P + PE SCHUKO
- voltage/current: 250 V~/16 A max.
- maximum load: 3 680 W
- type of insulation: PVC
- conductor: H05VV-F3G 1.0 mm<sup>2</sup>
- material of the sockets + plugs: plastic
- packaging: 1 pc, hanging

**P1321** 1/5/-/20  
19 22 130 150 SE1311



- length: 1.5 m
- number of sockets: 3× 2P + PE SCHUKO
- voltage/current: 250 V~/16 A max.
- maximum load: 3 680 W
- type of insulation: PVC
- conductor: H05VV-F3G 1 mm<sup>2</sup>
- material of the sockets + plugs: plastic
- packaging: 1 pc, hanging

**P1322** 1/5/-/20  
19 22 130 200 SE1312

- length: 2 m
- number of sockets: 3× 2P + PE SCHUKO
- voltage/current: 250 V~/16 A max.
- maximum load: 3 680 W
- type of insulation: PVC
- conductor: H05VV-F3G 1 mm<sup>2</sup>
- material of the sockets + plugs: plastic
- packaging: 1 pc, hanging

**P1422** 1/5/-/20  
19 22 140 200 SE1412

- length: 2 m
- number of sockets: 4× 2P + PE SCHUKO
- voltage/current: 250 V~/16 A max.
- maximum load: 3 680 W
- type of insulation: PVC
- conductor: H05VV-F3G 1 mm<sup>2</sup>
- material of the sockets + plugs: plastic
- packaging: 1 pc, hanging





www.emos.eu

Order Code  
Item Number



Packaging  
Type

**P1522** 1/5/-/15  
19 22 150 200 SE1512

- length: 2 m
- number of sockets: 5× 2P + PE SCHUKO
- voltage/current: 250 V~/16 A max.
- maximum load: 3 680 W
- type of insulation: PVC
- conductor: H05VV-F3G 1 mm<sup>2</sup>
- material of the sockets + plugs: plastic
- packaging: 1 pc, hanging

**P1622** 1/-/-/10  
19 22 160 200 SE1612

- length: 2 m
- number of sockets: 6× 2P + PE SCHUKO
- voltage/current: 250 V~/10 A max.
- maximum load: 2 300 W
- type of insulation: PVC
- conductor: H05VV-F3G 1.0 mm<sup>2</sup>
- material of the sockets + plugs: plastic
- packaging: 1 pc, hanging

**PC1321** 1/5/-/20  
19 22 330 150 SE1311





- length: 1.5 m
- number of sockets: 3× 2P + PE SCHUKO
- voltage/current: 250 V~/16 A max.
- maximum load: 3 680 W
- type of insulation: PVC
- conductor: H05VV-F3G 1 mm<sup>2</sup>
- material of the sockets + plugs: plastic
- packaging: 1 pc, hanging



**P04219GU** 1/-/3/12  
19 22 040 191 P04219U







- length: 1.9 m
- number of sockets: 4× 2P + PE SCHUKO
- voltage/current: 250 V~/16 A max.
- maximum load: 3 680 W
- type of insulation: PVC
- conductor: H05VV-F3G 1.5 mm<sup>2</sup>
- material of the sockets + plugs: PC
- packaging: 1 pc, box

**PS1721** 1/5/10/20  
19 22 570 150 GES-002



- length: 1.5 m
- number of sockets: 3× 2P + PE + 4× 2P
- voltage/current: 250 V~/10 A max.
- maximum load: 2 300 W
- type of insulation: PVC
- conductor: H05VV-F3G 1 mm<sup>2</sup>
- material of the sockets + plugs: plastic
- packaging: 1 pc, hanging

**P0221U** 1/5/-/20  
19 02 020 150 P0221U



- length: 1.5 m
- material of the sockets + plugs: plastic
- maximum load: 3 680 W
- voltage/current: 250 V~/16 A max.
- number of sockets: 2× 2P + PE
- packaging: 1 pc, hanging
- type of insulation: PVC
- conductor: H05VV-F3G 1.5 mm<sup>2</sup>

**P1321PD** 1/-/-/10  
19 02 330 154 P1321PD



- length: 1.5 m
- number of sockets: 3× 2P + PE SCHUKO
- maximum load: 3 680 W
- conductor cross section: 1.5 mm<sup>2</sup>
- conductor: H05VV-F
- type of insulation: PVC
- children protection
- packaging: 1 ks, box

**P0121** 1/5/-/20  
19 22 010 150 P0121



- length: 1.4 m
- number of sockets: 1× 2P + PE SCHUKO
- voltage/current: 250 V~/16 A max.
- maximum load: 3 680 W
- type of insulation: PVC
- conductor: H05VV-F3G 1.0 mm<sup>2</sup>
- material of the sockets + plugs: plastic
- packaging: 1 pc, hanging

**P0422** 1/5/-/20  
19 22 040 400 SE0412







- length: 2 m
- number of sockets: 4× 2P + PE SCHUKO
- voltage/current: 250 V~/16 A max.
- maximum load: 3 680 W
- type of insulation: PVC
- conductor: H05VV-F3G 1.0 mm<sup>2</sup>
- material of the sockets + plugs: plastic
- packaging: 1 pc, hanging



**P0522** 1/5/-/20  
19 22 050 201 SE0512







- length: 2 m
- number of sockets: 5× 2P + PE SCHUKO
- voltage/current: 250 V~/16 A max.
- maximum load: 3 680 W
- type of insulation: PVC
- conductor: H05VV-F3G 1.0 mm<sup>2</sup>
- material of the sockets + plugs: plastic
- packaging: 1 pc, hanging



<b>P0621</b>	1/5/-/15	
19 22 060 151	SE0611	
		
<ul style="list-style-type: none"> <li>▪ length: 1.4 m</li> <li>▪ number of sockets: 6× 2P + PE SCHUKO</li> <li>▪ voltage/current: 250 V~/16 A max.</li> <li>▪ maximum load: 3 680 W</li> <li>▪ type of insulation: PVC</li> <li>▪ conductor: H05VV-F3G 1.0 mm<sup>2</sup></li> </ul>		
<ul style="list-style-type: none"> <li>▪ material of the sockets + plugs: plastic</li> <li>▪ packaging: 1 pc, hanging</li> </ul>		



<b>P0222CQ</b>	1/-/5/10	
19 22 120 200	P0222CQ	
		
<ul style="list-style-type: none"> <li>▪ length: 2 m</li> <li>▪ number of sockets: 2× 2P + PE SCHUKO</li> <li>▪ voltage/current: 250 V~/16 A max.</li> <li>▪ maximum load: 3 680 W</li> <li>▪ type of insulation: PVC</li> <li>▪ conductor: H05VV-F3G 1.5 mm<sup>2</sup></li> </ul>		
<ul style="list-style-type: none"> <li>▪ material of the sockets + plugs: PC</li> <li>▪ packaging: 1 pc, box</li> </ul>		

<b>P1421</b>	1/5/-/20	
19 22 140 153	SE1411	
		
<ul style="list-style-type: none"> <li>▪ length: 1.4 m</li> <li>▪ number of sockets: 4× 2P + PE SCHUKO</li> <li>▪ voltage/current: 250 V~/16 A max.</li> <li>▪ maximum load: 3 680 W</li> <li>▪ type of insulation: PVC</li> <li>▪ conductor: H05VV-F3G 1.0 mm<sup>2</sup></li> </ul>		
<ul style="list-style-type: none"> <li>▪ material of the sockets + plugs: plastic</li> <li>▪ packaging: 1 pc, hanging</li> </ul>		

<b>P1521</b>	1/5/-/15	
19 22 150 155	SE1511	
		
<ul style="list-style-type: none"> <li>▪ length: 1.4 m</li> <li>▪ number of sockets: 5× 2P + PE SCHUKO</li> <li>▪ voltage/current: 250 V~/16 A max.</li> <li>▪ maximum load: 3 680 W</li> <li>▪ type of insulation: PVC</li> <li>▪ conductor: H05VV-F3G 1.0 mm<sup>2</sup></li> </ul>		
<ul style="list-style-type: none"> <li>▪ material of the sockets + plugs: plastic</li> <li>▪ packaging: 1 pc, hanging</li> </ul>		

<b>P1523PD</b>	1/-/5/10	
19 22 150 305	P1523PD	
		
<ul style="list-style-type: none"> <li>▪ length: 3 m</li> <li>▪ number of sockets: 5× 2P + PE SCHUKO</li> <li>▪ voltage/current: 250 V~/16 A max.</li> <li>▪ maximum load: 3 680 W</li> <li>▪ type of insulation: PVC</li> <li>▪ conductor: H05VV-F3G 1.5 mm<sup>2</sup></li> </ul>		
<ul style="list-style-type: none"> <li>▪ material of the sockets + plugs: PC</li> <li>▪ packaging: 1 pc, box</li> </ul>		

<b>P1523CU</b>	1/5/-/10	
19 22 150 306	P1523CU	
		
<ul style="list-style-type: none"> <li>▪ length: 3 m</li> <li>▪ number of sockets: 5× 2P + PE SCHUKO</li> <li>▪ voltage/current: 250 V~/16 A max.</li> <li>▪ maximum load: 3 680 W</li> <li>▪ type of insulation: PVC</li> <li>▪ conductor: H05VV-F3G 1.5 mm<sup>2</sup></li> </ul>		
<ul style="list-style-type: none"> <li>▪ material of the sockets + plugs: plastic</li> <li>▪ packaging: 1 pc, hanging</li> </ul>		

<b>P1621</b>	1/5/-/10	
19 22 160 153	SE1611	
		
<ul style="list-style-type: none"> <li>▪ length: 1.4 m</li> <li>▪ number of sockets: 6× 2P + PE SCHUKO</li> <li>▪ voltage/current: 250 V~/16 A max.</li> <li>▪ maximum load: 3 680 W</li> <li>▪ type of insulation: PVC</li> <li>▪ conductor: H05VV-F3G 1.0 mm<sup>2</sup></li> </ul>		
<ul style="list-style-type: none"> <li>▪ material of the sockets + plugs: plastic</li> <li>▪ packaging: 1 pc, hanging</li> </ul>		

## Power supply extension cords and sockets

## SCHUKO

## Single socket extension cords

## 1-phase 16A with rubber insulation

- extension cable with 1 or 2 sockets, length 5–30 m
- neoprene or rubber insulation, IP44 enclosure
- conductor cross-section: 1.5 or 2.5 mm, max. load: 3 680 W
- black colour, round socket with lid, child socket covers

<b>P01805</b>	1/-/-/12	
19 21 010 504	P01805 (E-008)	
	 	
<ul style="list-style-type: none"> <li>▪ length: 5 m</li> <li>▪ conductor cross section: 1.5 mm<sup>2</sup></li> <li>▪ voltage: 230 V</li> <li>▪ current: 16 A</li> <li>▪ IP rating: IP44</li> <li>▪ number of sockets: 1</li> </ul>	<ul style="list-style-type: none"> <li>▪ thermal fuse: no</li> <li>▪ conductor: H07RN-F3G</li> <li>▪ max. unreel load: 16 A max./3 680 W</li> <li>▪ children protection</li> <li>▪ packaging: 1 pc, shrink</li> </ul>	

<b>P01810</b>	1/-/-/3	
19 21 031 000	P01810 (E-008)	
	 	
<ul style="list-style-type: none"> <li>▪ length: 10 m</li> <li>▪ conductor cross section: 1.5 mm<sup>2</sup></li> <li>▪ voltage: 230 V</li> <li>▪ current: 16 A</li> <li>▪ IP rating: IP44</li> <li>▪ number of sockets: 1</li> </ul>	<ul style="list-style-type: none"> <li>▪ thermal fuse: no</li> <li>▪ conductor: H07RN-F3G</li> <li>▪ max. unreel load: 16 A max./3 680 W</li> <li>▪ children protection</li> <li>▪ packaging: 1 pc, shrink</li> </ul>	

<b>P01820</b>	1/-/-/2	
19 21 032 000	P01820 (E-008)	
	 	
<ul style="list-style-type: none"> <li>▪ length: 20 m</li> <li>▪ conductor cross section: 1.5 mm<sup>2</sup></li> <li>▪ voltage: 230 V</li> <li>▪ current: 16 A</li> <li>▪ IP rating: IP44</li> <li>▪ number of sockets: 1</li> </ul>	<ul style="list-style-type: none"> <li>▪ thermal fuse: no</li> <li>▪ conductor: H07RN-F3G</li> <li>▪ max. unreel load: 16 A max./3 680 W</li> <li>▪ children protection</li> <li>▪ packaging: 1 pc, shrink</li> </ul>	

<b>P01830</b>	1/-/-/2	
19 21 033 000	P01830 (E-008)	
	 	
<ul style="list-style-type: none"> <li>▪ length: 30 m</li> <li>▪ conductor cross section: 1.5 mm<sup>2</sup></li> <li>▪ voltage: 230 V</li> <li>▪ current: 16 A</li> <li>▪ IP rating: IP44</li> <li>▪ number of sockets: 1</li> </ul>	<ul style="list-style-type: none"> <li>▪ thermal fuse: no</li> <li>▪ conductor: H07RN-F3G</li> <li>▪ max. unreel load: 16 A max./3 680 W</li> <li>▪ children protection</li> <li>▪ packaging: 1 pc, shrink</li> </ul>	

<b>P01810R</b>	1/-/-/3	
19 21 011 003	P01810R (E-008)	
	 	
<ul style="list-style-type: none"> <li>▪ length: 10 m</li> <li>▪ conductor cross section: 2.5 mm<sup>2</sup></li> <li>▪ voltage: 230 V</li> <li>▪ current: 16 A</li> <li>▪ IP rating: IP44</li> <li>▪ number of sockets: 1</li> </ul>	<ul style="list-style-type: none"> <li>▪ thermal fuse: no</li> <li>▪ conductor: H07RN-F3G</li> <li>▪ max. unreel load: 16 A max./3 680 W</li> <li>▪ children protection</li> <li>▪ packaging: 1 pc, shrink</li> </ul>	

<b>P01825R</b>	1/-/-/4	
19 21 012 502	P01825R (E-008)	
	 	
<ul style="list-style-type: none"> <li>▪ length: 25 m</li> <li>▪ conductor cross section: 2.5 mm<sup>2</sup></li> <li>▪ voltage: 230 V</li> <li>▪ current: 16 A</li> <li>▪ IP rating: IP44</li> <li>▪ number of sockets: 1</li> </ul>	<ul style="list-style-type: none"> <li>▪ thermal fuse: no</li> <li>▪ conductor: H07RN-F3G</li> <li>▪ max. unreel load: 16 A max./3 680 W</li> <li>▪ children protection</li> <li>▪ packaging: 1 pc, shrink</li> </ul>	



<b>P0701</b>	1/-/-/6	
19 21 021 000	E-012	
<ul style="list-style-type: none"> <li>▪ length: 10 m</li> <li>▪ conductor cross section: 1.5 mm<sup>2</sup></li> <li>▪ voltage: 230 V</li> <li>▪ current: 16 A</li> <li>▪ IP rating: IP44</li> <li>▪ number of sockets: 2</li> </ul>		
<ul style="list-style-type: none"> <li>▪ thermal fuse: no</li> <li>▪ conductor: H05RR-F3G</li> <li>▪ max. unreel load: 16 A max./3 680 W</li> <li>▪ children protection</li> <li>▪ packaging: 1 pc, shrink</li> </ul>		

<b>P0702</b>	1/-/-/4	
19 21 021 502	E-012	
<ul style="list-style-type: none"> <li>▪ length: 15 m</li> <li>▪ conductor cross section: 1.5 mm<sup>2</sup></li> <li>▪ voltage: 230 V</li> <li>▪ current: 16 A</li> <li>▪ IP rating: IP44</li> <li>▪ number of sockets: 2</li> </ul>		
<ul style="list-style-type: none"> <li>▪ thermal fuse: no</li> <li>▪ conductor: H05RR-F3G</li> <li>▪ max. unreel load: 16 A max./3 680 W</li> <li>▪ children protection</li> <li>▪ packaging: 1 pc, shrink</li> </ul>		

<b>P0703</b>	1/-/-/3	
19 21 022 000	E-012	
<ul style="list-style-type: none"> <li>▪ length: 20 m</li> <li>▪ conductor cross section: 1.5 mm<sup>2</sup></li> <li>▪ voltage: 230 V</li> <li>▪ current: 16 A</li> <li>▪ IP rating: IP44</li> <li>▪ number of sockets: 2</li> </ul>		
<ul style="list-style-type: none"> <li>▪ thermal fuse: no</li> <li>▪ conductor: H05RR-F3G</li> <li>▪ max. unreel load: 16 A max./3 680 W</li> <li>▪ children protection</li> <li>▪ packaging: 1 pc, shrink</li> </ul>		

<b>P0704</b>	1/-/-/2	
19 21 022 502	E-012	
<ul style="list-style-type: none"> <li>▪ length: 25 m</li> <li>▪ conductor cross section: 1.5 mm<sup>2</sup></li> <li>▪ voltage: 230 V</li> <li>▪ current: 16 A</li> <li>▪ IP rating: IP44</li> <li>▪ number of sockets: 2</li> </ul>		
<ul style="list-style-type: none"> <li>▪ thermal fuse: no</li> <li>▪ conductor: H05RR-F3G</li> <li>▪ max. unreel load: 16 A max./3 680 W</li> <li>▪ children protection</li> <li>▪ packaging: 1 pc, shrink</li> </ul>		

## 1-phase 16A with PVC weatherproof insulation

- extension cable with 1 socket, weather-proof insulation
- IP44 protection allows outdoor use
- wire cross-section: 1.5 mm<sup>2</sup>, max. load 3 680 W
- length: 10 and 20 metres, blue
- round socket with cover, child safety covers





<b>P01510W</b>	1/-/-/6	
19 21 611 000	P01510W	
<ul style="list-style-type: none"> <li>▪ length: 10 m</li> <li>▪ conductor cross section: 1.5 mm<sup>2</sup></li> <li>▪ voltage: 250 V~</li> <li>▪ current: 16 A</li> <li>▪ IP rating: IP44</li> <li>▪ number of sockets: 1</li> </ul>		
<ul style="list-style-type: none"> <li>▪ thermal fuse: no</li> <li>▪ conductor: AT-N05V3V3-F</li> <li>▪ max. unreel load: 16 A max./3 680 W</li> <li>▪ children protection</li> <li>▪ packaging: 1 pc, packet</li> </ul>		

<b>P01520W</b>	1/-/-/2	
19 21 612 000	P01520W	
<ul style="list-style-type: none"> <li>▪ length: 20 m</li> <li>▪ conductor cross section: 1.5 mm<sup>2</sup></li> <li>▪ voltage: 250 V~</li> <li>▪ current: 16 A</li> <li>▪ IP rating: IP44</li> <li>▪ number of sockets: 1</li> </ul>		
<ul style="list-style-type: none"> <li>▪ thermal fuse: no</li> <li>▪ conductor: AT-N05V3V3-F</li> <li>▪ max. unreel load: 16 A max./3 680 W</li> <li>▪ children protection</li> <li>▪ packaging: 1 pc, packet</li> </ul>		







## 1-phase 16A with PVC insulation





- 2–30 m extension cable with one socket
- conductor cross section: 1.5 mm, max. load: 3 680 W
- PVC insulation - ideal for the garage or workshop
- orange reflective colour - always visible to avoid tripping
- round socket, child socket covers

<b>P0123R</b>	1/5/-/20	
19 21 010 302	SE0113-1,5	
		
8 592920 064474		





- length: 3 m
- number of sockets: 1× 2P + PE SCHUKO
- voltage/current: 250 V~/16 A max.
- maximum load: 3 680 W
- type of insulation: PVC
- conductor: H05VV-F3G 1.5 mm<sup>2</sup>
- material of the sockets + plugs: plastic
- packaging: 1 pc, foil+hanging

<b>P0125R</b>	1/-/-/20	
19 21 010 503	SE0115-1,5	
		
8 592920 064481		





- length: 5 m
- number of sockets: 1× 2P + PE SCHUKO
- voltage/current: 250 V~/16 A max.
- maximum load: 3 680 W
- type of insulation: PVC
- conductor: H05VV-F3G 1.5 mm<sup>2</sup>
- material of the sockets + plugs: plastic
- packaging: 1 pc, hanging

<b>P0127R</b>	1/-/-/20	
19 21 010 701	SE0117-1,5	
		
8 592920 107409		

- length: 7 m
- number of sockets: 1× 2P + PE SCHUKO
- voltage/current: 250 V~/16 A max.
- maximum load: 3 680 W
- type of insulation: PVC
- conductor: H05VV-F3G 1.5 mm<sup>2</sup>
- material of the sockets + plugs: plastic
- packaging: 1 pc, foil+hanging

<b>P0120R</b>	1/-/-/10	
19 21 011 002	SE0110-1,5	
		
8 592920 064498		

- length: 10 m
- number of sockets: 1× 2P + PE SCHUKO
- voltage/current: 250 V~/16 A max.
- maximum load: 3 680 W
- type of insulation: PVC
- conductor: H05VV-F3G 1.5 mm<sup>2</sup>
- material of the sockets + plugs: plastic
- packaging: 1 pc, foil+hanging

<b>P0122</b>	1/5/-/20	
19 21 010 202	P0122	
		
8 592920 107393		

- length: 2 m
- number of sockets: 1× 2P + PE SCHUKO
- voltage/current: 250 V~/16 A max.
- maximum load: 3 680 W
- type of insulation: PVC
- conductor: H05VV-F3G 1.0 mm<sup>2</sup>
- material of the sockets + plugs: plastic
- packaging: 1 pc, foil+hanging

<b>P01215R</b>	1/-/-/6	
19 21 011 502	DG-YD01 (YC-DAX-2)	
		
8 592920 064528		

- length: 15 m
- conductor cross section: 1.5 mm<sup>2</sup>
- voltage: 230 V
- current: 16 A
- IP rating: IP20
- number of sockets: 1
- thermal fuse: no
- conductor: H05VV-F3G
- max. unreeled load: 16 A max./3 680 W
- children protection
- packaging: 1 pc, shrink

<b>P01220R</b>	1/-/-/6	
19 21 012 001	DG-YD01 (YC-DAX-2)	
		
8 592920 064535		

- length: 20 m
- conductor cross section: 1.5 mm<sup>2</sup>
- voltage: 230 V
- current: 16 A
- IP rating: IP20
- number of sockets: 1
- thermal fuse: no
- conductor: H05VV-F3G
- max. unreeled load: 16 A max./3 680 W
- children protection
- packaging: 1 pc, shrink

<b>P01225R</b>	1/-/-/4	
19 21 012 500	DG-YD01 (YC-DAX-2)	
		
8 592920 064542		

- length: 25 m
- conductor cross section: 1.5 mm<sup>2</sup>
- voltage: 230 V
- current: 16 A
- IP rating: IP20
- number of sockets: 1
- thermal fuse: no
- conductor: H05VV-F3G
- max. unreeled load: 16 A max./3 680 W
- children protection
- packaging: 1 pc, shrink



www.emos.eu

Order Code  
Item Number

Packaging  
Type

**P01230R**

1/-/-/4

19 21 013 001

P01230R



- length: 30 m
- conductor cross section: 1.5 mm<sup>2</sup>
- voltage: 230 V
- current: 16 A
- IP rating: IP20
- number of sockets: 1
- thermal fuse: no
- conductor: H05VV-F3G
- children protection
- packaging: 1 pc, shrink

# Power supply extension cords and sockets

## SCHUKO

### MOES

- demountable multi sockets
- max. current load: 16 A, IP20 enclosure
- plastic, white
- fitted with child socket covers

**P0320**

1/5/-/40

19 23 030 000

DG-DC03 (P03C)



- product: socket field
- voltage/current: 250 V~/16 A max.
- children protection
- IP rating: IP20
- material: plastic
- packaging: 1 pc, hanging

**P0520**

1/5/-/30

19 23 050 000

DG-DC05 (P05C)



- product: socket field
- voltage/current: 250 V~/16 A max.
- children protection
- IP rating: IP20
- material: plastic
- packaging: 1 pc, hanging

**P1320**

1/5/-/45

19 23 130 000

DG-DC03K (P13C)



- product: socket field
- voltage/current: 250 V~/16 A max.
- children protection
- IP rating: IP20
- material: plastic
- packaging: 1 pc, hanging

**P1520**

1/5/-/20

19 23 150 000

DG-DC05K (P15C)



- product: socket field
- voltage/current: 250 V~/16 A max.
- children protection
- IP rating: IP20
- material: plastic
- packaging: 1 pc, hanging

# Surge protectors

## Surge protectors EMOS SCHUKO

- extension cable with overvoltage protection
- protects TV, satellite or laptop from mains overvoltage
- black or white design, backlit switch & child socket covers

- rated voltage: 230 V~, 50 Hz
- maximum load: 3 680 W
- conductor: H05VV-F3G 1.5 mm<sup>2</sup>
- energy absorption: 900 J
- protection level Up: 1.7 kV (L/N-PE, L-N)
- open-circuit voltage UOC: 6 kV
- response time: <1 ns
- connection indicator
- surge protector indicator

- dimensions: 342 × 66 × 50 mm
- packaging: 1 pc, box

**P54212**

1/-/-/6

19 09 040 202

G3040

- rated voltage: 230 V~, 50 Hz
- maximum load: 3 680 W
- conductor: H05VV-F3G 1.5 mm<sup>2</sup>
- energy absorption: 1 800 J
- protection level Up: 1.7 kV (L/N-PE, L-N)
- open-circuit voltage UOC: 6 kV
- response time: <1 ns
- antenna (coaxial protection): yes, IEC
- connection indicator

- surge protector indicator
- dimensions: 342 × 66 × 50 mm
- packaging: 1 pc, box

**P54222**

1/-/-/6

19 09 040 203

G5142

- rated voltage: 230 V~, 50 Hz
- maximum load: 3 680 W
- conductor: H05VV-F3G 1.5 mm<sup>2</sup>
- energy absorption: 1 800 J
- protection level Up: 1.7 kV (L/N-PE, L-N)
- open-circuit voltage UOC: 6 kV
- response time: <1 ns
- tel./Fax/DSL protection: yes, tel./fax/DSL,RJ11/RJ
- antenna (coaxial protection): yes, IEC

- connection indicator
- surge protector indicator
- dimensions: 398 × 110 × 50 mm
- packaging: 1 pc, box

**P54252**

1/-/-/6





19 09 480 301





G5183





# Assembled cords





## 3-phase rubber





- 380 V~ extension cable, length: 5–25 m
- rubber insulation, ideal for outdoor use, enclosure: IP44
- conductor cross-section: 2.5 or 4.0 mm<sup>2</sup>
- max. load: 3 680 W or 22 000 W





<b>PM0902</b>	1/-/-/2	
19 14 071 100	PM0902	
		
8 595025 381088		
<ul style="list-style-type: none"> <li>▪ length: 10 m</li> <li>▪ conductor cross section: 2.5 mm<sup>2</sup></li> <li>▪ voltage: 400 V~</li> <li>▪ current: 16 A</li> <li>▪ IP rating: IP44</li> <li>▪ number of sockets: 1</li> </ul>	<ul style="list-style-type: none"> <li>▪ thermal fuse: no</li> <li>▪ conductor: CGSG 5C × H05RR-F</li> <li>▪ max. unreel load: 16 A max./11 040 W</li> <li>▪ children protection: no</li> <li>▪ packaging: 1 pc, packet</li> </ul>	

<b>PM0904</b>	1/-/-/2	
19 14 071 200	PM0904	
		
8 595025 381101		
<ul style="list-style-type: none"> <li>▪ length: 20 m</li> <li>▪ conductor cross section: 2.5 mm<sup>2</sup></li> <li>▪ voltage: 400 V~</li> <li>▪ current: 16 A</li> <li>▪ IP rating: IP44</li> <li>▪ number of sockets: 1</li> </ul>	<ul style="list-style-type: none"> <li>▪ thermal fuse: no</li> <li>▪ conductor: CGSG 5C × H05RR-F</li> <li>▪ max. unreel load: 16 A max./11 040 W</li> <li>▪ children protection: no</li> <li>▪ packaging: 1 pc, packet</li> </ul>	

<b>PM0905</b>	1/-/-/1	
19 14 071 250	PM0905	
		
8 595025 381118		
<ul style="list-style-type: none"> <li>▪ length: 25 m</li> <li>▪ conductor cross section: 2.5 mm<sup>2</sup></li> <li>▪ voltage: 400 V~</li> <li>▪ current: 16 A</li> <li>▪ IP rating: IP44</li> <li>▪ number of sockets: 1</li> </ul>	<ul style="list-style-type: none"> <li>▪ thermal fuse: no</li> <li>▪ conductor: CGSG 5C × H05RR-F</li> <li>▪ max. unreel load: 16 A max./11 040 W</li> <li>▪ children protection: no</li> <li>▪ packaging: 1 pc, packet</li> </ul>	

<b>PM1102</b>	1/-/-/2	
19 14 081 102	PM1102	
		
8 592920 110065		
<ul style="list-style-type: none"> <li>▪ length: 10 m</li> <li>▪ conductor cross section: 4,0 mm<sup>2</sup></li> <li>▪ voltage: 400 V~</li> <li>▪ current: 32 A</li> <li>▪ IP rating: IP44</li> <li>▪ number of sockets: 1</li> </ul>	<ul style="list-style-type: none"> <li>▪ thermal fuse: no</li> <li>▪ conductor: CGSG 5C × H07RN-F</li> <li>▪ max. unreel load: 32 A max./22 000 W</li> <li>▪ children protection: no</li> <li>▪ packaging: 1 pc, packet</li> </ul>	

<b>PM1103</b>	1/-/-/1	
19 14 081 103	PM1103	
		
8 592920 110072		
<ul style="list-style-type: none"> <li>▪ length: 15 m</li> <li>▪ conductor cross section: 4,0 mm<sup>2</sup></li> <li>▪ voltage: 400 V~</li> <li>▪ current: 32 A</li> <li>▪ IP rating: IP44</li> <li>▪ number of sockets: 1</li> </ul>	<ul style="list-style-type: none"> <li>▪ thermal fuse: no</li> <li>▪ conductor: CGSG 5C × H07RN-F</li> <li>▪ max. unreel load: 32 A max./22 000 W</li> <li>▪ children protection: no</li> <li>▪ packaging: 1 pc, packet</li> </ul>	

<b>PM1104</b>	1/-/-/1	
19 14 081 104	PM1104	
		
8 592920 110089		
<ul style="list-style-type: none"> <li>▪ length: 20 m</li> <li>▪ conductor cross section: 4,0 mm<sup>2</sup></li> <li>▪ voltage: 400 V~</li> <li>▪ current: 32 A</li> <li>▪ IP rating: IP44</li> <li>▪ number of sockets: 1</li> </ul>	<ul style="list-style-type: none"> <li>▪ thermal fuse: no</li> <li>▪ conductor: CGSG 5C × H07RN-F</li> <li>▪ max. unreel load: 32 A max./22 000 W</li> <li>▪ children protection: no</li> <li>▪ packaging: 1 pc, packet</li> </ul>	

PM1105

1/-/-1

19 14 081 105

PM1105



8 592920 110096



- length: 25 m
- conductor cross section: 4,0 mm<sup>2</sup>
- voltage: 400 V~
- current: 32 A
- IP rating: IP44
- number of sockets: 1
- thermal fuse: no
- conductor: CGSG 5C × H07RN-F
- max. unreel load: 32 A max./22 000 W
- children protection: no
- packaging: 1 pc, packet

## Cable reels

### SCHUKO

## 3-phase rubber

- 3phase extension cable on reel with neoprene insulation
- immune to water (IP44), extreme temperatures and oils
- power extension cable reel with thermal fuse
- stable stand, reel and rubber-coated grip

length: 25 m = conductor cross section: 1.5 mm<sup>2</sup> = voltage: 230 V~/400 V~ = current: 13 A = IP rating: IP44 = number of sockets: 1 = thermal fuse = conductor: H07RN-F = max. reeled load: 230 V~: 4.35 A max./1 000 W; 400 V~: 6.25 A max./2 500 W = max. unreel load: 230 V~: 13 A max./3 000 W; 400 V~: 12.5 A max./5 000 W = children protection = packaging: 1 pc, box



8 592920 025062

P192250

19 28 432 500

1/-/-1

E-102A

length: 33 m = conductor cross section: 2.5 mm<sup>2</sup> = voltage: 230 V~/400 V~ = current: 15 A = IP rating: IP44 = number of sockets: 1 = thermal fuse = conductor: H07RN-F = max. reeled load: 230 V~: 6.52 A max./1 500 W; 400 V~: 6.25 A max./2 500 W = max. unreel load: 230 V~: 15.22 A max./3 500 W; 400 V~: 16 A max./6 400 W = children protection = packaging: 1 pc, box



8 592920 091654

P19733

19 28 733 300

1/-/-1

EM7-533 IP44  
440V (E-017)



# 1-phase weatherproof PVC

- 1-phase extension cable on cable-reel, weather-proof insulation
- resistant to water (IP44), extreme temperatures and oils
- EMOS extension cable with thermal fuse
- stable stand, winding reel and rubberised handle

- length: 50 m
- conductor cross section: 1.5 mm<sup>2</sup>
- voltage: 230 V
- current: 16 A
- IP rating: IP44
- number of sockets: 4
- thermal fuse
- conductor: AT-N05V3V3-F
- max. reeled load: 4.8 A max./1 100 W

- max. unreeled load: 16 A max./3 680 W
- children protection: no
- other functions: guiding loop, cable reel brake
- packaging: 1 pc, box



**P08650W**

1/-/-1

19 28 745 000

P08650W

- length: 25 m
- conductor cross section: 1.5 mm<sup>2</sup>
- voltage: 230 V
- current: 16 A
- IP rating: IP44
- number of sockets: 4
- thermal fuse
- conductor: AT-N05V3V3-F
- max. reeled load: 4.8 A max./1 100 W

- max. unreeled load: 16 A max./3 680 W
- children protection: no
- other functions: guiding loop, cable reel brake
- packaging: 1 pc, box



**P08625W**

1/-/-1

19 28 742 500

P08625W

- length: 20 m
- conductor cross section: 1.5 mm<sup>2</sup>
- voltage: 230 V
- current: 13 A
- IP rating: IP44
- number of sockets: 3
- thermal fuse
- conductor: AT-N05V3V3-F
- max. reeled load: 4.35 A max./1 000 W

- max. unreeled load: 13.04 A max./3 000 W
- children protection: no
- other functions: 2× USB-A  $\Sigma$ 2.1 A max.
- packaging: 1 pc, box



**P08620W**

1/-/-1

19 28 732 000

P08620W

## 1-phase rubber

- 1phase extension cable on reel w/ neoprene/rubber insulation
- immune to water (IP44), extreme temperatures and oils
- power extension cable reel with thermal fuse
- stable stand, reel and rubber-coated grip

- length: 15 m
- conductor cross section: 1.5 mm<sup>2</sup>
- voltage: 230 V
- current: 13 A
- IP rating: IP44
- number of sockets: 4
- thermal fuse
- conductor: H07RN-F
- max. reeled load: 4.35 A max./1 000 W

- max. unreeled load: 13.04 A max./3 000 W
- children protection: no
- other functions: LED reflect. 20 W/1 600 lm/6 500 K
- packaging: 1 pc, box

**P08215**

1/-/-1

19 28 441 500

P08215

- length: 25 m
- conductor cross section: 1.5 mm<sup>2</sup>
- voltage: 230 V
- current: 16 A
- IP rating: IP44
- number of sockets: 4
- thermal fuse
- conductor: H07RN-F
- max. reeled load: 4.35 A max./1 000 W

- max. unreeled load: 16 A max./3 680 W
- children protection: no
- other functions: guiding loop, cable reel brake
- packaging: 1 pc, box

**P19222**

1/-/-1

19 28 242 502

P19222

- length: 40 m
- conductor cross section: 2.5 mm<sup>2</sup>
- voltage: 230 V
- current: 16 A
- IP rating: IP44
- number of sockets: 4
- thermal fuse
- conductor: H07RN-F
- max. reeled load: 5.2 A max./1 200 W

- max. unreeled load: 16 A max./3 680 W
- children protection: no
- other functions: guiding loop, cable reel brake
- packaging: 1 pc, box

**P19224**

1/-/-1

19 28 544 000

P19224

- length: 50 m
- conductor cross section: 1.5 mm<sup>2</sup>
- voltage: 230 V
- current: 16 A
- IP rating: IP44
- number of sockets: 4
- thermal fuse
- conductor: H07RN-F
- max. reeled load: 4.35 A max./1 000 W

- max. unreeled load: 16 A max./3 680 W
- children protection: no
- other functions: guiding loop, cable reel brake
- packaging: 1 pc, box

**P19223**

1/-/-1

19 28 245 003

P19223

- length: 50 m
- conductor cross section: 2.5 mm<sup>2</sup>
- voltage: 230 V
- current: 15 A
- IP rating: IP44
- number of sockets: 4
- thermal fuse
- conductor: H07RN-F
- max. reeled load: 6.52 A max./1 500 W

- max. unreeled load: 15.22 A max./3 500 W
- children protection
- packaging: 1 pc, box



**P19220** 1/-/-/1  
19 28 545 001 E-017

- length: 50 m
- conductor cross section: 2.5 mm<sup>2</sup>
- voltage: 230 V
- current: 15 A
- IP rating: IP44
- number of sockets: 4
- thermal fuse
- conductor: H05RR-F
- max. reeled load: 6.52 A max./1 500 W

- max. unreeled load: 15.22 A max./3 500 W
- children protection
- packaging: 1 pc, box



**P19221** 1/-/-/1  
19 28 545 011 E-017

- length: 25 m
- conductor cross section: 1.5 mm<sup>2</sup>
- voltage: 230 V
- current: 16 A
- IP rating: IP44
- number of sockets: 4
- thermal fuse
- conductor: H05RR-F3G
- max. reeled load: 4.8 A max./1 100 W

- max. unreeled load: 16 A max./3 680 W
- children protection
- packaging: 1 pc, box



**P08225** 1/-/-/1  
19 28 242 500 E-10P

- length: 50 m
- conductor cross section: 1.5 mm<sup>2</sup>
- voltage: 230 V
- current: 16 A
- IP rating: IP44
- number of sockets: 4
- thermal fuse
- conductor: H05RR-F3G
- max. reeled load: 4.8 A max./1 100 W

- max. unreeled load: 16 A max./3 680 W
- children protection
- packaging: 1 pc, box



**P08250** 1/-/-/1  
19 28 245 000 E-10DP

- length: 25 m
- conductor cross section: 2.5 mm<sup>2</sup>
- voltage: 230 V
- current: 16 A
- IP rating: IP44
- number of sockets: 4
- thermal fuse
- conductor: H05RR-F3G
- max. reeled load: 6 A max./1 600 W

- max. unreeled load: 16 A max./3 680 W
- children protection
- packaging: 1 pc, box



**P19625** 1/-/-/1  
19 28 542 500 E-10P

# 1-phase PVC

- 1phase extension cable on reel with PVC insulation
- stable stand, reel and rubber-coated grip
- power extension cable reel with thermal fuse
- some also with backlit switch and guide loop (for reeling)

- length: 25 m
- conductor cross section: 1.5 mm<sup>2</sup>
- voltage: 230 V
- current: 13 A
- IP rating: IP20
- number of sockets: 4
- thermal fuse
- conductor: H05VV-F3G
- max. reeled load: 4.35 A max./1 000 W

- max. unreeled load: 13 A max./3 000 W
- children protection
- other functions: guiding loop, cable reel brake, switch
- packaging: 1 pc, box



**P19427** 1/-/-1  
19 28 042 507 HJR-4BA



- length: 25 m
- conductor cross section: 1.5 mm<sup>2</sup>
- voltage: 230 V
- current: 16 A
- IP rating: IP20
- number of sockets: 4
- thermal fuse
- conductor: H05VV-F3G
- max. reeled load: 4.8 A max./1 100 W

- max. unreeled load: 16 A max./3 680 W
- children protection: no
- packaging: 1 pc, box



**P092251** 1/-/-1  
19 28 042 504 P092251



- length: 50 m
- conductor cross section: 1.5 mm<sup>2</sup>
- voltage: 230 V
- current: 16 A
- IP rating: IP20
- number of sockets: 4
- thermal fuse
- conductor: H05VV-F3G
- max. reeled load: 4.8 A max./1 100 W

- max. unreeled load: 16 A max./3 680 W
- children protection: no
- other functions: guiding loop, cable reel brake, switch
- packaging: 1 pc, box



**P092501** 1/-/-1  
19 28 045 003 P092501



- length: 25 m
- conductor cross section: 2.5 mm<sup>2</sup>
- voltage: 230 V
- current: 16 A
- IP rating: IP20
- number of sockets: 4
- thermal fuse
- conductor: H05VV-F3G
- max. reeled load: 6 A max./1 600 W

- max. unreeled load: 16 A max./3 600 W
- children protection
- packaging: 1 pc, box



**P09225M** 1/-/-1  
19 28 042 501 E-4







- length: 40 m
- conductor cross section: 2.5 mm<sup>2</sup>
- voltage: 230 V
- current: 16 A
- IP rating: IP20
- number of sockets: 4
- thermal fuse
- conductor: H05VV-F3G
- max. reeled load: 6 A max./1 380 W

- max. unreeled load: 16 A max./3 600 W
- children protection
- packaging: 1 pc, box



**P09240M** 1/-/-/1  
19 28 044 001 E-4

- length: 25 m
- conductor cross section: 1.5 mm<sup>2</sup>
- voltage: 230 V
- current: 16 A
- IP rating: IP20
- number of sockets: 4
- thermal fuse
- conductor: H05VV-F3G
- max. reeled load: 4.8 A max./1 100 W

- max. unreeled load: 16 A max./3 600 W
- children protection: no
- packaging: 1 pc, box



**P09225** 1/-/-/1  
19 28 042 500 DG-4ZR-DB04 (HJR-4A)

- length: 40 m
- conductor cross section: 1.5 mm<sup>2</sup>
- voltage: 230 V
- current: 16 A
- IP rating: IP20
- number of sockets: 4
- thermal fuse
- conductor: H05VV-F
- max. reeled load: 4.8 A max./1 100 W

- max. unreeled load: 16 A max./3 600 W
- children protection: no
- packaging: 1 pc, box

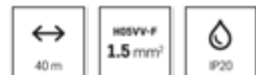

**P09240** 1/-/-/1  
19 28 044 000 E-4

- length: 50 m
- conductor cross section: 1.5 mm<sup>2</sup>
- voltage: 230 V
- current: 16 A
- IP rating: IP20
- number of sockets: 4
- thermal fuse
- conductor: H05VV-F3G
- max. reeled load: 4.8 A max./1 100 W

- max. unreeled load: 16 A max./3 600 W
- children protection: no
- packaging: 1 pc, box



**P09250** 1/-/-/1  
19 28 045 000 DG-4ZR-DB04 (HJR-4)

- length: 20 m
- conductor cross section: 1.0 mm<sup>2</sup>
- voltage: 230 V
- current: 10 A
- IP rating: IP20
- number of sockets: 4
- thermal fuse
- conductor: H05VV-F3G
- max. reeled load: 4.8 A max./1 100 W

- max. unreeled load: 10 A max./2 300 W
- children protection: no
- packaging: 1 pc, box



**P09220** 1/-/-/1  
19 28 142 000 DG-4ZR-DB04 (HJR-4AC)



- length: 15 m
- conductor cross section: 1.0 mm<sup>2</sup>
- voltage: 230 V
- current: 10 A
- IP rating: IP20
- number of sockets: 4
- thermal fuse
- conductor: H05VV-F3G
- max. reeled load: 4 A max./920 W

- max. unreeled load: 10 A max./2 300 W
- children protection: no
- packaging: 1 pc, box



**P19515**

1/-/-2

19 28 141 500

E-4ZR-15M-D04

- length: 10 m
- conductor cross section: 1.0 mm<sup>2</sup>
- voltage: 230 V
- current: 10 A
- IP rating: IP20
- number of sockets: 4
- thermal fuse
- conductor: H05VV-F3G
- max. reeled load: 4 A max./920 W

- max. unreeled load: 10 A max./2 300 W
- children protection: no
- packaging: 1 pc, box



**P19510**

1/-/-6

19 28 141 000

P19510(E-XD04)

## Sockets, plugs, adaptors, timers, others

### Holders

- extension cable holder, allows fixing to a wall
- in version for 3–4 or 5–6 sockets
- from thin white plastic that visually blends into the wall

**P0003C**

1/5/20/80

19 04 030 000

P3



- product: holder for sockets of extension
- material: plastic
- packaging: 1 pc, hanging



**P0004C**

1/-/20/80

19 04 040 000

P0004C



- product: holder for sockets of extension
- material: plastic
- packaging: 1 pc, hanging





## Plugs, sockets

- accessories for assembling an extension cable
- enclosure: IP20, IP44 or IP65 and max. current load: 16 A
- straight or thin angle plugs – allow furniture close to wall
- many with loop for hanging (cable kept off the ground)
- sockets also fitted with child covers

**P0047** 1/5/-/200  
19 26 010 100 EM-GBYC-01



8 595025 391865







- product: socket for the flexible cord – st
- voltage/current: 250 V~/16 A max.
- children protection
- IP rating: IP20
- material: plastic
- packaging: 1 pc, hanging

**P0066** 1/10/-/100  
19 06 100 090 E-GRC-03



8 592920 038284







- product: ultra thin fork for the flexible c
- voltage/current: 250 V~/16 A max.
- maximum load: 3 680 W
- IP rating: IP20
- material: plastic
- packaging: 1 pc, hanging

**P0039** 1/10/-/280  
19 06 100 050 EM-GRC-02



8 595025 391834







- product: plug for the flexible cord, angul
- voltage/current: 250 V~/16 A max.
- maximum load: 3 680 W
- IP rating: IP20
- material: plastic
- packaging: 1 pc, hanging

**P0038** 1/5/-/200  
19 06 110 300 EM-GRC-01



8 595025 391841







- product: plug for the flexible cord, straig
- voltage/current: 250 V~/16 A max.
- maximum load: 3 680 W
- IP rating: IP20
- material: plastic
- packaging: 1 pc, hanging

**P0034** 1/5/-/150  
19 06 110 200 YC-FA-4Z



8 595025 363862

- product: plug for the flexible cord, straig
- voltage/current: 250 V~/16 A max.
- maximum load: 3 680 W
- IP rating: IP20
- material: plastic
- packaging: 1 pc, hanging

**P0049** 1/5/30/60  
19 26 010 200 YC-DA-14



8 592920 000397







- product: the gum socket for the flexible
- voltage/current: 250 V~/16 A max.
- children protection
- IP rating: IP44
- material: rubber
- packaging: 1 pc, hanging

**P0050** 1/5/20/80  
19 06 100 060 YC-DA-14Z



8 592920 000366







- product: the gum fork for the flexible co
- voltage/current: 250 V~/16 A max.
- maximum load: 3 680 W
- IP rating: IP44
- material: rubber
- packaging: 1 pc, hanging

**P0072** 1/-/6/36  
19 05 010 003 P0072



8 592920 078211

- product: USB socket
- voltage/current: 250 V~/16 A max.
- children protection
- IP rating: IP20
- material: plastic
- packaging: 1 pc, hanging

## Adaptors

- splitter sockets with 1–4 outlets, fitted with child covers
- enable connecting multiple devices into one socket
- max. load 2 300 or 3 680 W, IP20 enclosure
- for connecting devices with round or flat plugs
- with or without switch

**P00242**

1/4/-/200

19 25 030 020

KF-Z-01/03A



8 595025 325013



- product: adapter plug 3×
- voltage/current: 250 V~/10 A max.
- IP rating: IP20
- material: plastic
- packaging: 1 pc, hanging

**P0063**

1/5/-/30

19 05 120 010

ES-01/02K



8 592920 036907



- product: adapter plug 2× with switch
- voltage/current: 250 V~/16 A max.
- maximum load: 3 680 W
- children protection
- IP rating: IP20
- material: plastic
- packaging: 1 pc, hanging

**P00252**

1/5/40/80

19 25 030 030

ODL-158



8 595025 390790



- product: adapter plug 2×
- voltage/current: 250 V~/10 A max.
- children protection
- IP rating: IP20
- material: plastic
- packaging: 1 pc, hanging

**P00262**

1/5/80/160

19 25 030 040

P00262 (GES-058)



8 595025 390820



- product: socket with switch
- voltage/current: 250 V~/16 A max.
- children protection
- IP rating: IP20
- material: plastic
- packaging: 1 pc, hanging

**P00272**

1/4/-/60

19 25 030 050

P00272 (GES-073)



8 595025 390851



- product: adapter plug 3×
- voltage/current: 250 V~/16 A max.
- children protection
- IP rating: IP20
- material: plastic
- packaging: 1 pc, hanging

**P00282**

1/5/-/80

19 25 030 060

P00282 (GES-098)



8 595025 390882



- product: adapter plug 3× with switch
- voltage/current: 250 V~/16 A max.
- children protection
- IP rating: IP20
- material: plastic
- packaging: 1 pc, hanging

**P00292**

1/-/4/40

19 25 030 090

P00292



8 592920 078242



- product: socket with switch
- voltage/current: 250 V~/16 A max.
- children protection
- IP rating: IP44
- material: plastic
- packaging: 1 pc, hanging

## Travel adaptors

- travel aid for connecting to FRENCH and SCHUKO sockets
- often in the form of universal adapter w/ min. 5 plug types
- can be used in more than 150 world countries
- also with adapter w/ SCHUKO socket (used in DE, HU, SI etc.)
- max. current load of 10 or 16 A

- designed for: for Europeans travelling abroad
- using: America, Asia, Australia, New Zealand, China,
- packaging: 1 pc, small box



8 592920 120897

**P0056N**

19 10 000 900

1/-/-/20

1.103145

- designed for: for foreigners arriving in Europe and h
- using: plugs (USA, GB, JP, CN, AU etc.) into the SCH
- packaging: 1 pc, small box



8 592920 076323

**P0055N**

19 10 000 800

1/-/-/50

WORLD TO  
EUROPE 2.0

## Timers

- socket with timer automatically turns appliance on/off
- ideal for aquariums, terrariums, pool pumps and lighting
- mechanical timer sockets or more practical digital timers
- digital timer to plan out your week using 8–20 programmes
- can handle a max. load of 3 680 W

- type: digital
- voltage/current: 230 V~/16 A max.
- maximum load: 3 680 W
- minimal time setting: 1 minute
- option of manual switch-on
- number of programs: 8
- number of switching per day: 8
- function to change summer/winter time
- IP rating: IP20

▪ packaging: 1 pc, box



8 592920 117880

**P5521N**

19 27 110 012

1/-/4/16

TS-ED1

- type: mechanical
- voltage/current: 230 V~/16 A max.
- maximum load: 3 680 W
- minimal time setting: 30 minutes
- option of manual switch-on
- number of switching per day: 48
- IP rating: IP20
- packaging: 1 pc, box

**P5523N**

1/-/4/16

19 27 010 023

15GD-3A-1

- type: mechanical
- outdoor using
- voltage/current: 230 V~/16 A max.
- maximum load: 3 680 W
- minimal time setting: 30 minutes
- option of manual switch-on: no
- number of switching per day: 48
- IP rating: IP44
- packaging: 1 pc, box

**P5526N**

1/-/4/16

19 27 110 033

EMT450

- type: mechanical
- voltage/current: 230 V~/16 A max.
- maximum load: 3 680 W
- minimal time setting: 15 minutes
- option of manual switch-on
- number of switching per day: 96
- IP rating: IP20
- packaging: 1 pc, box

**P5522**

1/-/4/16

19 27 010 010

1E/2A

3 680 W  
max.

- type: digital
- outdoor using
- voltage/current: 230 V~/16 A max.
- maximum load: 3 680 W
- minimal time setting: 1 minute
- option of manual switch-on
- number of programs: 10
- number of switching per day: 10
- function to change summer/winter time

- IP rating: IP44
- packaging: 1 pc, box

**P5525**

1/-/4/12

19 27 110 020

TGE-5B (TGE-5)

3 680 W  
max.

- product: remote-controlled sockets, 2 sockets + 1×
- voltage/current: 250 V~/13 A max.
- maximum load: 3 000 W
- children protection
- IP rating: IP44
- material: plastic
- remote control: power supply 1× 3 V CR2032 (inclu
- packaging: 1 pc, small box

**P0068**

1/-/-/18

19 05 111 001

52023+50074

3 000 W  
max.



- product: remote-controlled sockets, 3 sockets + 1x
- voltage/current: 230 V~/4.35 A max.
- maximum load: 1 000 W
- children protection
- IP rating: IP20
- material: plastic
- number of positions: 2P + PE
- remote control: power supply 1x 3 V CR2032 (inclu
- packaging: 1 pc, small box



**P0069** 1/-/3/18  
19 05 120 030 P0064

## Energy consumption meters

- socket-powered wattmeter to measure appliance's consumption
- helps reduce expenses for electricity
- max. load 3 680 W
- displays: voltage, current, active power and power factor
- also fitted with child covers

- maximum load: 3 680 W
- voltage/current: 230 V~/16 A max.
- measuring range: 2 W-3 680 W
- range of power consumption: 0 kWh-9 999 kWh
- dimensions: 150 × 75 × 75 mm
- packaging: 1 pc, box



**P5822** 1/2/-/16  
19 31 000 020 P5822

## GoSmart sockets

- Remote on/off switching of connected appliances
- Overview of electricity consumption of connected appliances
- Schedule creation and automatic ON/OFF settings
- Setting up delayed shutdown of appliances
- Network connection via WIFI or Bluetooth protocols
- Compatibility with EMOS GoSmart products and TUYA devices
- Voice control with Google Assistant and Amazon Alexa

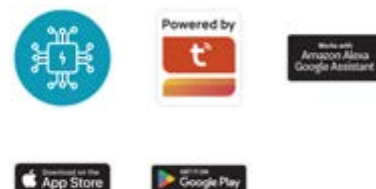

- product: Wi-Fi socket
  - maximum load: 3 680 W
  - voltage/current: 230 V~/16 A max.
  - transmission frequency: 2.4 GHz WIFI
  - children protection
  - supported OS: Android, iOS
  - compatibility: EMOS GoSmart, TUYA, LIDL, Smartlife
  - protocol: Wi-Fi
  - control by voice assistants
- notifications to the mobile app



**P5531** 1/-/1/32  
19 36 055 310 IP-3002S

- product: Wi-Fi timer/wattmeter-outside
- maximum load: 3 680 W
- voltage/current: 230 V~/16 A max.
- transmission frequency: 2,4 GHz
- children protection
- supported OS: Android, iOS
- compatibility: EMOS GoSmart, TUYA, LIDL, Smartlife
- protocol: Wi-Fi
- control by voice assistants
- notifications to the mobile app



**P5532**  
19 36 055 320

1/-/-/30  
IP-3006S

- product: ZigBee socket
- maximum load: 3 680 W
- voltage/current: 230 V~/16 A max.
- transmission frequency: 2,4 GHz
- children protection
- supported OS: Android, iOS
- compatibility: EMOS GoSmart, TUYA, LIDL, Smartlife
- protocol: Zigbee 3.0
- control by voice assistants
- notifications to the mobile app



**P5533**  
19 36 553 300

1/-/-/32  
IP-3009S

- product: ZigBee socket
- maximum load: 3 680 W
- voltage/current: 230 V~/16 A max.
- transmission frequency: 2,4 GHz
- children protection
- supported OS: Android, iOS
- compatibility: EMOS GoSmart, TUYA, LIDL, Smartlife
- protocol: Zigbee 3.0
- control by voice assistants
- notifications to the mobile app



**P5534**  
19 36 553 400

1/-/-/30  
IP-3010S

## Industrial plugs, 380 V sockets

- wall-mounted industrial plugs and sockets
- with max. current load of 16 or 32 A
- body made of plastic, screw terminals or screw-free design
- 3 phases, voltage 380–415 V, 4–5 poles

**A6210** 1/-/10/40  
31 06 213 240 513.1656



- product: wall socket
- voltage/current: 380–415 V~/16 A
- IP rating: IP44
- material: plastic
- number of positions: 4
- packaging: no packaging



**A6212** 1/-/10  
31 06 213 242 513.3256



- product: wall socket
- voltage/current: 380–415 V~/32 A
- IP rating: IP44
- material: plastic
- number of positions: 4
- packaging: no packaging



**A6211** 1/-/10/40  
31 06 213 241 513.1657



- product: wall socket
- voltage/current: 380–415 V~/16 A
- IP rating: IP44
- material: plastic
- number of positions: 5
- packaging: no packaging



**A6213** 1/-/10  
31 06 213 243 513.3257



- product: wall socket
- voltage/current: 380–415 V~/32 A
- IP rating: IP44
- material: plastic
- number of positions: 5
- packaging: no packaging



**A6310** 1/-/10/50  
31 06 213 150 313.1646



- product: coupler
- voltage/current: 380–415 V~/16 A
- IP rating: IP44
- material: plastic
- number of positions: 4
- packaging: no packaging



**A6312** 1/-/10/40  
31 06 213 152 313.3246



- product: coupler
- voltage/current: 380–415 V~/32 A
- IP rating: IP44
- material: plastic
- number of positions: 4
- packaging: no packaging



**A6311** 1/-/10/50  
31 06 213 151 313.1647



- product: coupler
- voltage/current: 380–415 V~/16 A
- IP rating: IP44
- material: plastic
- number of positions: 5
- packaging: no packaging



**A6313** 1/-/10/40  
31 06 213 153 313.3247



- product: coupler
- voltage/current: 380–415 V~/32 A
- IP rating: IP44
- material: plastic
- number of positions: 5
- packaging: no packaging



**A6110** 1/-/10/50  
31 05 213 050 213.1636



- product: separate plug
- voltage/current: 380–415 V~/16 A
- IP rating: IP44
- material: plastic
- number of positions: 4
- packaging: no packaging



**A6114** 1/-/10/40  
31 05 213 054 213.3236



- product: separate plug
- voltage/current: 380–415 V~/32 A
- IP rating: IP44
- material: plastic
- number of positions: 4
- packaging: no packaging



**A6111** 1/-/10/50  
31 05 213 051 213.1637



- product: separate plug
- voltage/current: 380–415 V~/16 A
- IP rating: IP44
- material: plastic
- number of positions: 5
- packaging: no packaging



**A6115** 1/-/10/40  
31 05 213 055 213.3237



- product: separate plug
- voltage/current: 380–415 V~/32 A
- IP rating: IP44
- material: plastic
- number of positions: 5
- packaging: no packaging



# Flexo, assembled cords

## Rubber

### Two-cores



- rubber two-strand mobile cord with fixed-mount plug
- length 3 or 5 m, various cross sections, black

**S03030** 1/5/-/20

24 21 130 212 SY-10 (YC-B-2ZA, LA016A)



8 595025 348838





- conductor: H05RR-F
- length: 3 m
- type of insulation: rubber
- colour: black
- conductor cross section: 2× 1.0 mm<sup>2</sup>
- type: SY-10



▪ packaging: 1 pc, hanging

**S03050** 1/5/-/20

24 21 150 212 SY-10 (YC-B-2ZA, LA016A)



8 595025 348845





- conductor: H05RR-F
- length: 5 m
- type of insulation: rubber
- colour: black
- conductor cross section: 2× 1.0 mm<sup>2</sup>
- type: SY-10



▪ packaging: 1 pc, hanging

**S03330** 1/5/-/20

24 21 230 230 SY-10 (YC-B-2ZA, LA016A)



8 595025 382757





- conductor: H05RR-F
- length: 3 m
- type of insulation: rubber
- colour: black
- conductor cross section: 2× 1.5 mm<sup>2</sup>
- type: SY-10



▪ packaging: 1 pc, hanging

**S03350** 1/5/-/20

24 21 250 230 SY-10 (YC-B-2ZA, LA016A)



8 595025 382764





- conductor: H05RR-F
- length: 5 m
- type of insulation: rubber
- colour: black
- conductor cross section: 2× 1.5 mm<sup>2</sup>
- type: SY-10



▪ packaging: 1 pc, hanging

**S03030N** 1/5/-/20

24 21 130 213 S03030N



8 592920 130865





- conductor: H05RN-F
- length: 3 m
- type of insulation: rubber/neopren
- colour: black
- conductor cross section: 2× 1.0 mm<sup>2</sup>
- type: SY-10



▪ packaging: 1 pc, hanging

**S03031N** 1/5/-/20

24 21 130 214 S03031N



8 592920 130926

- conductor: H07RN-F
- length: 3 m
- type of insulation: rubber/neopren
- colour: black
- conductor cross section: 2× 1.0 mm<sup>2</sup>
- type: SY-10

▪ packaging: 1 pc, hanging

**S03050N**

1/5/-/20

24 21 150 213

S03050N



- conductor: H05RN-F
- length: 5 m
- type of insulation: rubber/neopren
- colour: black
- conductor cross section: 2× 1.0 mm<sup>2</sup>
- type: SY-10
- packaging: 1 pc, hanging

## Three-cores

- rubber three-strand mobile cord with fixed-mount plug
- length 3 or 5 m, various cross sections, black

**S03130**

1/-/5/15

24 25 130 220

SY-11 (GEP-003,  
LA017D)

- conductor: H05RR-F
- length: 3 m
- type of insulation: rubber
- colour: black
- conductor cross section: 3× 1.0 mm<sup>2</sup>
- type: SY-11
- packaging: 1 pc, hanging

**S03150**

1/5/-/15

24 25 150 220

SY-11 (GEP-003,  
LA017D)

- conductor: H05RR-F
- length: 5 m
- type of insulation: rubber
- colour: black
- conductor cross section: 3× 1.0 mm<sup>2</sup>
- type: SY-11
- packaging: 1 pc, hanging

**S03230**

1/-/5/25

24 25 230 220

SY-11 (GEP-003,  
LA017D)

- conductor: H05RR-F
- length: 3 m
- type of insulation: rubber
- colour: black
- conductor cross section: 3× 1.5 mm<sup>2</sup>
- type: SY-11
- packaging: 1 pc, hanging

**S03250**

1/5/-/10

24 25 250 220

SY-11 (GEP-003,  
LA017D)

- conductor: H05RR-F
- length: 5 m
- type of insulation: rubber
- colour: black
- conductor cross section: 3× 1.5 mm<sup>2</sup>
- type: SY-11
- packaging: 1 pc, hanging

**S03430**

1/-/5/10

24 25 430 230

SY-11 (GEP-003,  
LA017D)

- conductor: H05RR-F
- length: 3 m
- type of insulation: rubber
- colour: black
- conductor cross section: 3× 2.5 mm<sup>2</sup>
- type: SY-11
- packaging: 1 pc, hanging

**S03450**

1/-/5/10

24 25 450 230

SY-11 (GEP-003,  
LA017D)

- conductor: H05RR-F
- length: 5 m
- type of insulation: rubber
- colour: black
- conductor cross section: 3× 2.5 mm<sup>2</sup>
- type: SY-11
- packaging: 1 pc, hanging





**S00003** 1/5/-/30  
24 35 724 032  
KF-CR1-H05RR-F3G0.75MM2









- conductor: H05RR-F
- length: 2.4 m
- type of insulation: braided/rubber
- colour: white
- conductor cross section: 3× 0.75 mm<sup>2</sup>
- type: KF-CR1-H05RR-F

packaging: 1 pc, hanging





**S03130N** 1/-/5/15  
24 25 130 210  
S03130N

- conductor: H05RN-F
- length: 3 m
- type of insulation: rubber/neopren
- colour: black
- conductor cross section: 3× 1.0 mm<sup>2</sup>
- type: SY-11

packaging: 1 pc, hanging





**S03150N** 1/5/-/15  
24 25 150 210  
S03150N

- conductor: H05RN-F
- length: 5 m
- type of insulation: rubber/neopren
- colour: black
- conductor cross section: 3× 1.0 mm<sup>2</sup>
- type: SY-11

packaging: 1 pc, hanging





**S03210N** 1/-/-/6  
24 25 210 210  
S03210N

- conductor: H07RN-F
- length: 10 m
- type of insulation: rubber/neopren
- colour: black
- conductor cross section: 3× 1.5 mm<sup>2</sup>
- type: SY-11

packaging: 1 pc, hanging





**S03230N** 1/-/5/15  
24 25 230 210  
S03230N

- conductor: H07RN-F
- length: 3 m
- type of insulation: rubber/neopren
- colour: black
- conductor cross section: 3× 1.5 mm<sup>2</sup>
- type: SY-11

packaging: 1 pc, hanging

**S03250N** 1/5/-/10  
24 25 250 210  
S03250N

- conductor: H07RN-F
- length: 5 m
- type of insulation: rubber/neopren
- colour: black
- conductor cross section: 3× 1.5 mm<sup>2</sup>
- type: SY-11





packaging: 1 pc, hanging





# Flexo, assembled cords





## PVC





### Two-cores





- PVC two-strand mobile cord with fixed-mount plug
- black or white
- length 2, 3 or 5 m, various cross sections
- selected models fitted with switch





<b>S12252</b>	1/5/30/60	
24 01 520 132	HY020-F	
	 	
<ul style="list-style-type: none"> <li>▪ conductor: H03VVH2-F</li> <li>▪ length: 2 m</li> <li>▪ type of insulation: PVC</li> <li>▪ colour: white</li> <li>▪ conductor cross section: 2× 0.5 mm<sup>2</sup></li> <li>▪ type: KF-H1 (HY020-F)</li> </ul>		
▪ packaging: 1 pc, hanging		

<b>S15272</b>	1/5/35/70	
24 01 720 132	HY020-F	
	 	
<ul style="list-style-type: none"> <li>▪ conductor: H03VVH2-F</li> <li>▪ length: 2 m</li> <li>▪ type of insulation: PVC</li> <li>▪ colour: white</li> <li>▪ conductor cross section: 2× 0.75 mm<sup>2</sup></li> <li>▪ type: KF-H1 (HY020-F)</li> </ul>		
▪ packaging: 1 pc, hanging		



<b>S15273</b>	1/5/30/60	
24 01 730 132	HY020-F	
	 	
<ul style="list-style-type: none"> <li>▪ conductor: H03VVH2-F</li> <li>▪ length: 3 m</li> <li>▪ type of insulation: PVC</li> <li>▪ colour: white</li> <li>▪ conductor cross section: 2× 0.75 mm<sup>2</sup></li> <li>▪ type: KF-H1 (HY020-F)</li> </ul>		
▪ packaging: 1 pc, hanging		

<b>S15275</b>	1/5/-/30	
24 01 750 132	HY020-F	
	 	
<ul style="list-style-type: none"> <li>▪ conductor: H03VVH2-F</li> <li>▪ length: 5 m</li> <li>▪ type of insulation: PVC</li> <li>▪ colour: white</li> <li>▪ conductor cross section: 2× 0.75 mm<sup>2</sup></li> <li>▪ type: KF-H1 (HY020-F)</li> </ul>		
▪ packaging: 1 pc, hanging		

<b>S19272</b>	1/5/35/70	
24 01 720 232	HY020-F	
	 	
<ul style="list-style-type: none"> <li>▪ conductor: H03VVH2-F</li> <li>▪ length: 2 m</li> <li>▪ type of insulation: PVC</li> <li>▪ colour: black</li> <li>▪ conductor cross section: 2× 0.75 mm<sup>2</sup></li> <li>▪ type: KF-H1 (HY020-F)</li> </ul>		
▪ packaging: 1 pc, hanging		

<b>S19273</b>	1/5/30/60	
24 01 730 232	HY020-F	
	 	
<ul style="list-style-type: none"> <li>▪ conductor: H03VVH2-F</li> <li>▪ length: 3 m</li> <li>▪ type of insulation: PVC</li> <li>▪ colour: black</li> <li>▪ conductor cross section: 2× 0.75 mm<sup>2</sup></li> <li>▪ type: KF-H1 (HY020-F)</li> </ul>		
▪ packaging: 1 pc, hanging		



**S19275** 1/5/-/30  
24 01 750 232 HY020-F

- conductor: H03VVH2-F
- length: 5 m
- type of insulation: PVC
- colour: black
- conductor cross section: 2× 0.75 mm<sup>2</sup>
- type: KF-H1 (HY020-F)

▪ packaging: 1 pc, hanging



**S08272** 1/5/30/60  
24 02 720 132 KF-H1/S051E4

- conductor: H03VVH2-F
- length: 2 m
- type of insulation: PVC
- colour: white
- conductor cross section: 2× 0.75 mm<sup>2</sup>
- type: KF-H1/S051E4

▪ packaging: 1 pc, hanging



**S08273** 1/5/25/50  
24 02 730 132 KF-H1/S051E4

- conductor: H03VVH2-F
- length: 3 m
- type of insulation: PVC
- colour: white
- conductor cross section: 2× 0.75 mm<sup>2</sup>
- type: KF-H1/S051E4

▪ packaging: 1 pc, hanging



**S09272** 1/5/25/50  
24 02 720 232 KF-H1/S051E4

- conductor: H03VVH2-F
- length: 2 m
- type of insulation: PVC
- colour: black
- conductor cross section: 2× 0.75 mm<sup>2</sup>
- type: KF-H1/S051E4

▪ packaging: 1 pc, hanging



**S09273** 1/5/25/50  
24 02 730 232 KF-H1/S051E4

- conductor: H03VVH2-F
- length: 3 m
- type of insulation: PVC
- colour: black
- conductor cross section: 2× 0.75 mm<sup>2</sup>
- type: KF-H1/S051E4

▪ packaging: 1 pc, hanging

**S1111** 1/5/35/70  
24 00 517 252 KF-Y11-1(LY-21/LY-22)



- conductor: H03VVH2-F
- length: 1.75 m
- type of insulation: PVC
- colour: black
- conductor cross section: 2× 0.5 mm<sup>2</sup>
- type: KF-Y11-1

▪ packaging: 1 pc, hanging

## Three-cores

- PVC three-strand mobile cord with fixed-mount plug
- black or white
- length 2, 3 or 5 m, various cross sections



**S14372** 1/5/-/40  
24 13 720 132 KF-CR2 (HY005-F)

- conductor: H05VV-F 3G
- length: 2 m
- type of insulation: PVC
- colour: white
- conductor cross section: 3× 0.75 mm<sup>2</sup>
- type: KF-CR2 (HY005-F)

▪ packaging: 1 pc, hanging

**S14373** 1/5/-/30  
24 13 730 132 KF-CR2 (HY005-F)

- conductor: H05VV-F 3G
- length: 3 m
- type of insulation: PVC
- colour: white
- conductor cross section: 3× 0.75 mm<sup>2</sup>
- type: KF-CR2 (HY005-F)

▪ packaging: 1 pc, hanging

**S14375**

1/5/-/25

24 13 750 132

KF-CR2 (HY005-F)



- conductor: H05VV-F 3G
- length: 5 m
- type of insulation: PVC
- colour: white
- conductor cross section: 3× 0.75 mm<sup>2</sup>
- type: KF-CR2 (HY005-F)

• packaging: 1 pc, hanging

**S14312**

1/5/-/35

24 13 120 132

KF-CR2 (HY005-F)



- conductor: H05VV-F 3G
- length: 2 m
- type of insulation: PVC
- colour: white
- conductor cross section: 3× 1.0 mm<sup>2</sup>
- type: KF-CR2 (HY005-F)

• packaging: 1 pc, hanging

**S14313**

1/5/-/30

24 13 130 132

KF-CR2 (HY005-F)



- conductor: H05VV-F 3G
- length: 3 m
- type of insulation: PVC
- colour: white
- conductor cross section: 3× 1.0 mm<sup>2</sup>
- type: KF-CR2 (HY005-F)

• packaging: 1 pc, hanging

**S14315**

1/5/-/20

24 13 150 132

KF-CR2 (HY005-F)



- conductor: H05VV-F 3G
- length: 5 m
- type of insulation: PVC
- colour: white
- conductor cross section: 3× 1.0 mm<sup>2</sup>
- type: KF-CR2 (HY005-F)

• packaging: 1 pc, hanging

**S14322**

1/5/-/35

24 13 220 132

KF-CR2 (HY005-F)



- conductor: H05VV-F 3G
- length: 2 m
- type of insulation: PVC
- colour: white
- conductor cross section: 3× 1.5 mm<sup>2</sup>
- type: KF-CR2 (HY005-F)

• packaging: 1 pc, hanging

**S14323**

1/5/-/30

24 13 230 132

KF-CR2 (HY005-F)



- conductor: H05VV-F 3G
- length: 3 m
- type of insulation: PVC
- colour: white
- conductor cross section: 3× 1.5 mm<sup>2</sup>
- type: KF-CR2 (HY005-F)

• packaging: 1 pc, hanging

**S14325**

1/5/-/20

24 13 250 132

KF-CR2 (HY005-F)



- conductor: H05VV-F 3G
- length: 5 m
- type of insulation: PVC
- colour: white
- conductor cross section: 3× 1.5 mm<sup>2</sup>
- type: KF-CR2 (HY005-F)

• packaging: 1 pc, hanging

**S18372**

1/5/-/40

24 13 720 232

KF-CR2 (HY005-F)



- conductor: H05VV-F 3G
- length: 2 m
- type of insulation: PVC
- colour: black
- conductor cross section: 3× 0.75 mm<sup>2</sup>
- type: KF-CR2 (HY005-F)

• packaging: 1 pc, hanging

**S18373**

1/5/-/35

24 13 730 232

KF-CR2 (HY005-F)



- conductor: H05VV-F 3G
- length: 3 m
- type of insulation: PVC
- colour: black
- conductor cross section: 3× 0.75 mm<sup>2</sup>
- type: KF-CR2 (HY005-F)

• packaging: 1 pc, hanging

**S18312**

1/5/-/40

24 13 120 232

KF-CR2 (HY005-F)



- conductor: H05VV-F 3G
- length: 2 m
- type of insulation: PVC
- colour: black
- conductor cross section: 3× 1.0 mm<sup>2</sup>
- type: KF-CR2 (HY005-F)

• packaging: 1 pc, hanging

**S18313**

1/5/-/35

24 13 130 232

KF-CR2 (HY005-F)



8 595025 318688



- conductor: H05VV-F 3G
  - length: 3 m
  - type of insulation: PVC
  - colour: black
  - conductor cross section: 3× 1.0 mm<sup>2</sup>
  - type: KF-CR2 (HY005-F)
- packaging: 1 pc, hanging

**S18315**

1/5/-/20

24 13 150 232

KF-CR2 (HY005-F)



8 595025 318695



- conductor: H05VV-F 3G
  - length: 5 m
  - type of insulation: PVC
  - colour: black
  - conductor cross section: 3× 1.0 mm<sup>2</sup>
  - type: KF-CR2 (HY005-F)
- packaging: 1 pc, hanging

**S18322**

1/5/-/35

24 13 220 232

KF-CR2 (HY005-F)



8 595025 318701



- conductor: H05VV-F 3G
  - length: 2 m
  - type of insulation: PVC
  - colour: black
  - conductor cross section: 3× 1.5 mm<sup>2</sup>
  - type: KF-CR2 (HY005-F)
- packaging: 1 pc, hanging

**S18323**

1/5/-/30

24 13 230 232

KF-CR2 (HY005-F)



8 595025 318718



- conductor: H05VV-F 3G
  - length: 3 m
  - type of insulation: PVC
  - colour: black
  - conductor cross section: 3× 1.5 mm<sup>2</sup>
  - type: KF-CR2 (HY005-F)
- packaging: 1 pc, hanging

**S18325**

1/5/-/20

24 13 250 232

KF-CR2 (HY005-F)



8 595025 318725



- conductor: H05VV-F 3G
  - length: 5 m
  - type of insulation: PVC
  - colour: black
  - conductor cross section: 3× 1.5 mm<sup>2</sup>
  - type: KF-CR2 (HY005-F)
- packaging: 1 pc, hanging

**S11370**

1/-/-/50

24 17 715 202

JT003/JT-ST3  
(LA010A)

8 595025 323118



- conductor: H05VV-F 3G
  - length: 1.5 m
  - type of insulation: PVC
  - colour: black
  - conductor cross section: 3× 0.75 mm<sup>2</sup>
  - type: JT003/JT-ST3
- packaging: 1 pc, hanging



# Cables



## Data cables UTP, FTP

### Data cables CAT 5E

- EMOS structured cabling components always in top quality
- guarantee maximum output, flawless running, long life
- UTP/FTP cables meet standards EN 50173, ANSI/TIA/EIA 568
- also comply with ISO/IEC 11801
- certified by accredited testing and calibration laboratory
- meet standard ČSN EN 50575 (reaction to fire)

type: UTP CAT 5E PVC BASIC = cable structure: wire = material of the inner conductor: copper (Cu) = wire insulation: HDPE = strength member: Nylon 150D = cable sheath: PVC = jacket diameter: 5.0 mm = highest supported protocol: 1000 Base-T (Gigabit Ethernet) = reaction to the fire: Eca = dangerous substances: none = packaging: 305 m, paper box

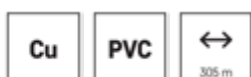

**S9134**

305/-/-/305

23 09 010 120 UTP CAT5E PVC BASIC

type: UTP CAT 5E PVC = cable structure: wire = material of the inner conductor: copper (Cu) = wire insulation: HDPE = strength member: Nylon 150D = cable sheath: PVC = jacket diameter: 5.2 mm = highest supported protocol: 1000 Base-T (Gigabit Ethernet) = reaction to the fire: Eca = dangerous substances: none = packaging: 305 m, paper box



**S9121**

305/-/-/305

23 09 010 010 UTP CAT5E PVC



type: UTP CAT 5E LSZH = cable structure: wire = material of the inner conductor: copper (Cu) = wire insulation: HDPE = strength member: Nylon 150D = cable sheath: LSZH = jacket diameter: 5.2 mm = low smoke zero halogen (LSZH) coat = highest supported protocol: 1000 Base-T (Gigabit Ethernet) = reaction to the fire: Dca-s2-d2-a1 = dangerous substances: none = packaging: 305 m, paper box



**S9129** 305/-/-/305  
23 09 010 090 UTP CAT5E LSZH

type: FTP CAT 5E PVC = cable structure: wire = shielding: Al/PET 7/12-18 mm = material of the inner conductor: copper (Cu) = wire insulation: HDPE = strength member: Nylon 150D = cable sheath: PVC = jacket diameter: 6.0 mm = highest supported protocol: 1000 Base-T (Gigabit Ethernet) = reaction to the fire: Eca = dangerous substances: none = packaging: 305 m, paper box



**S9221** 305/-/-/305  
23 09 110 010 FTP CAT5E PVC

type: FTP CAT 5E LSZH = cable structure: wire = shielding: Al/PET 7/12-18 mm = material of the inner conductor: copper (Cu) = wire insulation: HDPE = strength member: Nylon 150D = cable sheath: LSZH = jacket diameter: 6.0 mm = low smoke zero halogen (LSZH) coat = highest supported protocol: 1000 Base-T (Gigabit Ethernet) = reaction to the fire: Dca-s2-d2-a1 = dangerous substances: none = packaging: 305 m, paper box



**S9222** 305/-/-/305  
23 09 110 020 FTP CAT5E LSZH

type: UTP CAT 5E CCA OEM = cable structure: wire = material of the inner conductor: copper clad Al (CCA) = wire insulation: HDPE = strength member: Nylon 150D = cable sheath: PVC = jacket diameter: 5.2 mm = highest supported protocol: 100 Base-TX = reaction to the fire: Eca = dangerous substances: none = packaging: 305 m, paper box

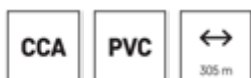

**S9128** 305/-/-/305  
23 09 010 080 UTP CAT5E CCA

type: UTP CAT 5E 1M = cable structure: stranded wires = material of the inner conductor: copper clad Al (CCA) = wire insulation: HDPE = strength member: Nylon 150D = cable sheath: PVC = jacket diameter: 5 mm = highest supported protocol: 1000 Base-T (Gigabit Ethernet) = reaction to the fire: do not subject to CPR = dangerous substances: do not subject to CPR = packaging: 1 pc, PVC packet



**S9122** 1/5/25/100  
23 09 010 020 UTP CAT5E PVC  
1M



www.emos.eu

Order Code  
Item Number

Packaging  
Type

type: UTP CAT 5E 2M = cable structure: stranded wires = material of the inner conductor: copper clad Al (CCA)  
= wire insulation: HDPE = strength member: Nylon 150D = cable sheath: PVC = jacket diameter: 5 mm =  
highest supported protocol: 1000 Base-T (Gigabit Ethernet) = reaction to the fire: do not subject to CPR =  
dangerous substances: do not subject to CPR = packaging: 1 pc, PVC packet



↔ 2 m	CAT 5E	RJ45 2x	1000 BASE-T			5 YEARS WARRANTY
----------	-----------	------------	----------------	--	--	---------------------



**S9123** 1/-/-/60  
23 09 010 030 UTP CAT5E PVC  
2M

type: UTP CAT 5E 3M = cable structure: stranded wires = material of the inner conductor: copper clad Al (CCA)  
= wire insulation: HDPE = strength member: Nylon 150D = cable sheath: PVC = jacket diameter: 5 mm =  
highest supported protocol: 1000 Base-T (Gigabit Ethernet) = reaction to the fire: do not subject to CPR =  
dangerous substances: do not subject to CPR = packaging: 1 pc, PVC packet



↔ 3 m	CAT 5E	RJ45 2x	1000 BASE-T			5 YEARS WARRANTY
----------	-----------	------------	----------------	--	--	---------------------



**S9124** 1/-/-/10/40  
23 09 010 040 UTP CAT5E PVC  
3M

type: UTP CAT 5E 5M = cable structure: stranded wires = material of the inner conductor: copper clad Al (CCA)  
= wire insulation: HDPE = strength member: Nylon 150D = cable sheath: PVC = jacket diameter: 5 mm =  
highest supported protocol: 1000 Base-T (Gigabit Ethernet) = reaction to the fire: do not subject to CPR =  
dangerous substances: do not subject to CPR = packaging: 1 pc, PVC packet



↔ 5 m	CAT 5E	RJ45 2x	1000 BASE-T			5 YEARS WARRANTY
----------	-----------	------------	----------------	--	--	---------------------



**S9125** 1/-/-/10/20  
23 09 010 050 UTP CAT5E PVC  
5M

type: UTP CAT 5E 10M = cable structure: stranded wires = material of the inner conductor: copper clad Al (CCA)  
= wire insulation: HDPE = strength member: Nylon 150D = cable sheath: PVC = jacket diameter: 5 mm =  
highest supported protocol: 1000 Base-T (Gigabit Ethernet) = reaction to the fire: do not subject to CPR =  
dangerous substances: do not subject to CPR = packaging: 1 pc, PVC packet



↔ 10 m	CAT 5E	RJ45 2x	1000 BASE-T			5 YEARS WARRANTY
-----------	-----------	------------	----------------	--	--	---------------------



**S9126** 1/-/-/10/30  
23 09 010 060 UTP CAT5E PVC  
10M

type: UTP CAT 5E 15M = cable structure: stranded wires = material of the inner conductor: copper clad Al (CCA)  
= wire insulation: HDPE = strength member: Nylon 150D = cable sheath: PVC = jacket diameter: 5 mm =  
highest supported protocol: 1000 Base-T (Gigabit Ethernet) = reaction to the fire: do not subject to CPR =  
dangerous substances: do not subject to CPR = packaging: 1 pc, PVC packet



↔ 15 m	CAT 5E	RJ45 2x	1000 BASE-T			5 YEARS WARRANTY
-----------	-----------	------------	----------------	--	--	---------------------



**S9127** 1/-/-/5/20  
23 09 010 070 UTP CAT5E PVC  
15M



type: UTP CAT 5E 25M = cable structure: stranded wires = material of the inner conductor: copper clad Al (CCA) = wire insulation: HDPE = cable sheath: PVC = jacket diameter: 5 mm = highest supported protocol: 1000 Base-T (Gigabit Ethernet) = reaction to the fire: do not subject to CPR = dangerous substances: do not subject to CPR = packaging: 1 pc, PVC packet



**S9130** 1/-/-/10  
23 09 010 100 UTP CAT5E PVC  
25M

## Data cables CAT 6

- EMOS structured cabling components always in top quality
- guarantee maximum output, flawless running, long life
- UTP/FTP cables meet standards EN 50173, ANSI/TIA/EIA 568
- also comply with ISO/IEC 11801
- certified by accredited testing and calibration laboratory
- meet standard ČSN EN 50575 (reaction to fire)

type: UTP CAT 6 PVC = cable structure: wire = material of the inner conductor: copper (Cu) = wire insulation: HDPE = strength member: 150D nylon + PE cross = cable sheath: PVC = jacket diameter: 6.3 mm = highest supported protocol: 1000 Base-TX (Gigabit Ethernet) = reaction to the fire: Eca = dangerous substances: none = packaging: 305 m, paper box



**S9131** 305/-/-/305  
23 09 020 010 UTP CAT6 PVC

type: UTP CAT 6 LSZH = cable structure: wire = material of the inner conductor: copper (Cu) = wire insulation: HDPE = strength member: 150D nylon + PE cross = cable sheath: LSZH = jacket diameter: 6.3 mm = low smoke zero halogen (LSZH) coat = highest supported protocol: 1000 Base-TX (Gigabit Ethernet) = reaction to the fire: Dca-s2-d2-a2 = dangerous substances: none = packaging: 305 m, paper box



**S9132** 305/-/-/305  
23 09 020 020 UTP CAT6 LSZH

type: FTP CAT 6 LSZH = cable structure: wire = shielding: Al/PET 7/12-18 mm = material of the inner conductor: copper (Cu) = wire insulation: HDPE = strength member: 150D nylon + PE cross = cable sheath: LSZH = jacket diameter: 6.3 mm = highest supported protocol: 1000 Base-T (Gigabit Ethernet) = reaction to the fire: Dca-s2-d2-a2 = dangerous substances: none = packaging: 500 m, wooden drum



**S9230** 500/-/-/500  
23 09 120 010 FTP CAT6 LSZH

type: STP CAT 6A LSZH = cable structure: wire = shielding: Al/PET 7/12-18 mm = material of the inner conductor: copper (Cu) = wire insulation: HDPE = strength member: 150D nylon + PE cross = cable sheath: LSZH = jacket diameter: 7.6 mm = low smoke zero halogen (LSZH) coat = highest supported protocol: 10GBASE-T = reaction to the fire: B2ca-s1-d1-a1 = dangerous substances: none = packaging: 500 m, wooden drum



**S9310** 500/-/-/500  
23 09 130 010 STP CAT6A LSZH

type: FFTP CAT 6A LSZH = cable structure: wire = shielding: Al/PET 7/12-18 mm = material of the inner conductor: copper (Cu) = wire insulation: HDPE = strength member: 150D nylon + PE cross = cable sheath: LSZH = jacket diameter: 7.6 mm = low smoke zero halogen (LSZH) coat = highest supported protocol: 10GBASE-T = reaction to the fire: Dca-s1-d2-a1 = dangerous substances: none = packaging: 500 m, wooden drum



**S9320** 500/-/-/500  
23 09 130 020 FFTP CAT6A LSZH

## Connectors, patch accessories

### Connection patch cables, accessories

- for data transfer in computer and telecommunication networks
- terminate in RJ45 connectors (in category CAT5E or CAT6)
- length: 1-25 m, diameter: 5 mm, PVC jacket, 5 year warranty
- separate RJ45 (CAT5E) sockets and connectors also available

- type: connector RJ45 8p8c = packaging: 20 pcs, PVC packet
- category: CAT6
- designed for cable: UTP
- using: solid wire
- min. lifetime: 1 000 connect/disconnect cycles
- storage temperature: -40-70 °C
- operating temperature: -10-60 °C
- maximum operating humidity: 93 %
- dimensions: 22 × 12 × 10 mm



**K0103** 20/-/-/5 000  
18 21 000 700 RJ45 6 UTP SOLID



- type: connector RJ45 8p8c
- category: CAT5E
- designed for cable: FTP, SFTP, F/UTP
- using: solid wire
- shielding
- min. lifetime: 1 000 connect/disconnect cycles
- storage temperature: -40–70 °C
- operating temperature: -10–60 °C
- maximum operating humidity: 93 %
- dimensions: 22 × 12 × 10 mm
- packaging: 20 pcs, PVC packet



**K0201**

20/-/-/5 000

18 21 100 100

RJ45 5E FTP  
SOLID

- type: connector RJ45 8p8c
- category: CAT6
- designed for cable: FTP, SFTP, F/UTP
- using: solid wire
- shielding
- min. lifetime: 1 000 connect/disconnect cycles
- storage temperature: -40–70 °C
- operating temperature: -10–60 °C
- maximum operating humidity: 93 %
- dimensions: 22 × 12 × 10 mm
- packaging: 20 pcs, PVC packet



**K0202**

20/-/-/5 000

18 21 100 200

RJ45 6 FTP SOLID

- type: RJ45 connector protection
- using: reduces the stress of RJ45 connector
- dimensions: 30 × 13 × 11 mm
- packaging: 20 pcs, PVC packet



**K0141**

20/-/-/5 000

18 21 000 400

RJ45 PROOF  
BLACK

- type: RJ45 connector protection
- using: reduces the stress of RJ45 connector
- dimensions: 30 × 13 × 11 mm
- packaging: 20 pcs, PVC packet



**K0151**

20/-/-/5 000

18 21 000 600

RJ45 PROOF  
GRAY

- type: connector RJ45 8p8c
- category: CAT5E
- designed for cable: UTP
- using: litz wire
- min. lifetime: 1 000 connect/disconnect cycles
- storage temperature: -40–70 °C
- operating temperature: -10–60 °C
- maximum operating humidity: 93 %
- dimensions: 22 × 12 × 10 mm
- packaging: 20 pcs, PVC packet



**K0101**

20/-/-/5 000

18 21 000 100

RJ45 5E UTP  
WIRE

- type: connector RJ45 8p8c
  - category: CAT5E
  - designed for cable: UTP
  - using: solid wire
  - min. lifetime: 1 000 connect/disconnect cycles
  - storage temperature: -40-70 °C
  - operating temperature: -10-60 °C
  - maximum operating humidity: 93 %
  - dimensions: 22 × 12 × 10 mm
- packaging: 20 pcs, PVC packet



<b>K0102</b>	20/-/-/5 000
18 21 000 500	RJ45 5E UTP SOLID

- type: UTP socket wall mount
- reaction to the fire: do not subject to CPR
- dangerous substances: do not subject to CPR
- packaging: 1 pc, PVC packet



<b>J0401</b>	1/-/25/250
25 12 000 100	2XRJ45 SOCKET

- type: keystone RJ45 CAT5E
  - category: CAT5E
  - designed for cable: UTP
  - using: solid wire
  - min. lifetime: 1 000 connect/disconnect cycles
  - storage temperature: -40-70 °C
  - operating temperature: -10-60 °C
  - maximum operating humidity: 93 %
  - dimensions: 31 × 20 × 15 mm
- packaging: 1 pc, PVC packet



<b>K0301</b>	1/10/-/500
18 21 000 800	KSTUTP CAT5E

- type: keystone RJ45 CAT5E
  - category: CAT5E
  - designed for cable: FTP, SFTP, F/UTP
  - using: solid wire
  - shielding
  - min. lifetime: 1 000 connect/disconnect cycles
  - storage temperature: -40-70 °C
  - operating temperature: -10-60 °C
  - maximum operating humidity: 93 %
- dimensions: 31 × 20 × 15 mm
  - packaging: 1 pc, PVC packet



<b>K0311</b>	1/10/-/500
18 21 100 300	KSTFTP CAT5E

- type: keystone RJ45 CAT6
  - category: CAT6
  - designed for cable: FTP, SFTP, F/UTP
  - using: solid wire
  - shielding
  - min. lifetime: 1 000 connect/disconnect cycles
  - storage temperature: -40-70 °C
  - operating temperature: -10-60 °C
  - maximum operating humidity: 93 %
- dimensions: 31 × 20 × 15 mm
  - packaging: 1 pc, PVC packet



<b>K0312</b>	1/10/-/500
18 21 100 301	KSTFTP CAT6

## Connectors IEC, F, reductions

- IEC connectors: straight/angle couplers, plugs and sockets
- F connectors available as straight/angled, screwed/inserted
- F connector size depends on coaxial cable thickness (4–5 mm)

**K1331** 10/-/-/2 500  
A203R

18 04 100 100



8 595025 356710



10×

- version: plug
- type: direct
- packaging: 10 pcs, packet

**K1731** 10/-/-/2 500  
A204R

18 04 000 100



8 595025 356796



10×

- version: socket
- type: direct
- packaging: 10 pcs, packet

**K1451** 10/-/-/2 500  
A224

18 04 100 500



8 595025 356772



10×

- version: plug
- type: angular
- packaging: 10 pcs, packet

**K1851** 10/-/-/2 500  
A224F

18 04 000 500



8 595025 356857



10×

- version: socket
- type: angular
- packaging: 10 pcs, packet

**K1421** 10/-/-/2 500  
A205R

18 04 100 300



8 595025 356741



10×

- version: plug
- type: angular
- packaging: 10 pcs, packet

**K1821** 10/-/-/2 500  
A206R

18 04 000 300



8 595025 356826



10×

- version: socket
- type: angular
- packaging: 10 pcs, packet

**R5060** 10/-/-/2 500  
A223R

18 04 300 100



8 595025 357472



10×

- version: coupling
- type: direct
- packaging: 10 pcs, packet

**K7311** 10/-/-/4 000  
M5609L

18 07 100 300



8 595025 357311



10×

- version: screw plug
- type: screwing
- for coax: 3C2V
- dimensions: 4.0/4.9 mm
- packaging: 10 pcs, packet

**K7321** 10/-/-/4 000  
18 07 100 400 M5609M



8 595025 357328



10x

- version: plug
- type: screwing
- for coax: CB-500
- dimensions: 4.0/5.5 mm
- packaging: 10 pcs, packet

**K7331** 10/-/-/4 000  
18 07 100 500 M5609H



8 595025 357335



10x

- version: plug
- type: screwing
- for coax: CB-100
- dimensions: 5.0/6.5 mm
- packaging: 10 pcs, packet

**K7351** 10/-/-/4 000  
18 07 100 700 M7351T



8 595025 357359



10x

- version: plug
- type: screwing
- for coax: CB-113N
- dimensions: 5.0/7.0 mm
- packaging: 10 pcs, packet

**R5602** 10/-/-/4 000  
18 07 300 100 M5602



8 595025 357502



10x

- version: coupling
- type: screwing
- for coax: any
- packaging: 10 pcs, packet

**R5610** 10/-/-/2 000  
18 07 300 200 M5610



8 595025 357519



10x

- version: coupling
- type: screwing
- for coax: any
- packaging: 10 pcs, packet

**R5639** 10/-/-/2 000  
18 07 200 100 M5639



8 595025 357526



10x

- version: reduction
- type: screwing
- for coax: any
- packaging: 10 pcs, packet

**R5851** 10/-/-/2 000  
18 07 200 600 M5851



8 595025 357588



10x

- version: reduction IEC-F
- type: screwing/slip-on
- for coax: any
- packaging: 10 pcs, packet

**R5852** 10/-/-/2 000  
18 07 200 700 M5852



8 595025 357595



10x

- version: reduction F-IEC
- type: screwing/slip-on
- for coax: any
- packaging: 10 pcs, packet

**R5553** 10/-/-/1 500  
18 07 200 300 M5553



8 595025 357496



10x

- version: reduction F-BNC
- type: screwing/slip-on
- for coax: any
- packaging: 10 pcs, packet

**R5850** 10/-/-/2 000  
18 07 200 500 M5850



8 595025 357571



10x

- version: reduction F-IEC
- type: screwing/slip-on
- for coax: any
- packaging: 10 pcs, packet

**K9304** 1/150/-/150  
18 11 000 200 K9304



8 595025 321350



- connectors: SCART – 3× CINCH + SVHS
- switch IN/OUT
- packaging: 1 pc, packet

**K1731.2** 2/-/20/480  
18 04 000 600 K1731.2



8 592920 086032



- version: socket
- type: direct
- packaging: 2 pc, paper blister

**K1821.2** 2/-/20/480  
18 04 000 601 K1821.2



8 592920 086049



- version: socket
- type: angular
- packaging: 2 pc, paper blister

**K1851.2** 2/-/20/480  
18 04 000 602 K1851.2



8 592920 086056



- version: socket
- type: angular
- packaging: 2 pc, paper blister

**K1331.2** 2/-/20/480  
18 04 100 701 K1331.2



8 592920 086063



- version: plug
- type: direct
- packaging: 2 pc, paper blister

**K1421.2** 2/-/20/480  
18 04 100 702 K1421.2



8 592920 086070



- version: plug
- type: angular
- packaging: 2 pc, paper blister

**K1451.2** 2/-/20/480  
18 04 100 703 K1451.2



8 592920 086087



- version: plug
- type: angular
- packaging: 2 pc, paper blister

**R5060.2** 2/-/20/480  
18 04 300 200 R5060.2



8 592920 086094



- version: coupling
- type: direct
- packaging: 2 pc, paper blister

**K7321.2** 2/-/20/480  
18 07 100 800 K7321.2



8 592920 086100



- version: plug
- type: screwing
- for coax: CB-500
- dimensions: 4.0/5.5 mm
- packaging: 2 pc, paper blister

**K7331.2** 2/-/20/480  
18 07 100 801 K7331.2



8 592920 086117



- version: plug
- type: screwing
- for coax: CB-100
- dimensions: 5.0/6.5 mm
- packaging: 2 pc, paper blister





www.emos.eu

Order Code  
Item Number

Packaging  
Type

**K7351.2**

2/-/20/480

18 07 100 802

K7351.2



- version: plug
- type: screwing
- for coax: CB-113N
- dimensions: 5.0/7.0 mm
- packaging: 2 pc, paper blister

**R5850.2**

2/-/20/480

18 07 100 803

R5850.2



- version: reduction F-IEC
- type: screwing/slip-on
- for coax: any
- packaging: 2 pc, paper blister

**R5852.2**

2/-/20/480

18 07 100 804

R5852.2



- version: reduction F-IEC
- type: screwing/slip-on
- for coax: any
- packaging: 2 pc, paper blister

**R5639.2**

2/-/20/480

18 07 201 000

R5639.2



- version: reduction
- type: screwing
- for coax: any
- packaging: 2 pc, paper blister

**R5602.2**

2/-/20/480

18 07 300 300

R5602.2



- version: coupling
- type: screwing
- for coax: any
- packaging: 2 pc, paper blister

**R5610.2**

2/-/20/480

18 07 300 301

R5610.2



- version: coupling
- type: screwing
- for coax: any
- packaging: 2 pc, paper blister

## Twin-shielded cables CYH

- transparent audio dual links made of OFC
- copper purity: 99.999 %
- CYH dual links in white or black

- conductor cross section: 0.75 mm<sup>2</sup>
- diameter of the inner conductor: 105× 0.095 mm
- sheath color: transparent, transparent
- maximum operating voltage: 50 V
- packaging: 100 m, reel



**S8307**  
23 08 207 500

100/-/-/400  
SPTP075

- conductor cross section: 1.0 mm<sup>2</sup>
- diameter of the inner conductor: 140× 0.095 mm
- sheath color: transparent, transparent
- maximum operating voltage: 50 V
- packaging: 100 m, reel



**S8310** 100/-/-/400  
23 08 210 000 SPTP100

- conductor cross section: 1.5 mm<sup>2</sup>
- diameter of the inner conductor: 210× 0.095 mm
- sheath color: transparent, transparent
- maximum operating voltage: 50 V
- packaging: 100 m, reel



**S8314** 100/-/-/200  
23 08 215 000 SPTP150

- conductor cross section: 2.5 mm<sup>2</sup>
- diameter of the inner conductor: 350× 0.095 mm
- sheath color: transparent, transparent
- maximum operating voltage: 50 V
- packaging: 100 m, reel



**S8324** 100/-/-/200  
23 08 225 000 SPTP250

- conductor cross section: 2.5 mm<sup>2</sup>
- diameter of the inner conductor: 123× 0.16 mm
- sheath color: transparent, transparent
- maximum operating voltage: 50 V
- packaging: 100 m, PE foil

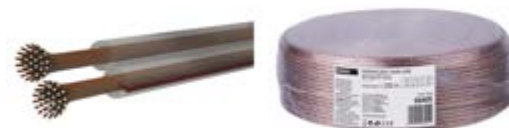

**S8405** 100/-/-/200  
23 08 325 000 SPTP250 ECO

- conductor cross section: 0.15 mm<sup>2</sup>
- diameter of the inner conductor: 14× 0.12 mm
- sheath color: white, white
- maximum operating voltage: 50 V
- packaging: 200 m, reel



**S8131** 200/-/-/800  
23 08 201 510 BCYH015W



- conductor cross section: 0.35 mm<sup>2</sup>
- diameter of the inner conductor: 30× 0.12 mm
- sheath color: white, white
- maximum operating voltage: 50 V
- packaging: 100 m, reel



**S8231** 100/-/-/400  
23 08 203 510 BCYH035W



- conductor cross section: 0.5 mm<sup>2</sup>
- diameter of the inner conductor: 45× 0.12 mm
- sheath color: white, white
- maximum operating voltage: 50 V
- packaging: 100 m, reel



**S8251** 100/-/-/400  
23 08 205 010 BCYH050W



- conductor cross section: 0.75 mm<sup>2</sup>
- diameter of the inner conductor: 67× 0.12 mm
- sheath color: white, white
- maximum operating voltage: 50 V
- packaging: 100 m, reel



**S8271** 100/-/-/400  
23 08 207 510 BCYH075W



- conductor cross section: 1.0 mm<sup>2</sup>
- diameter of the inner conductor: 90× 0.12 mm
- sheath color: white, white
- maximum operating voltage: 50 V
- packaging: 100 m, reel



**S8281** 100/-/-/200  
23 08 210 010 BCYH100W



- conductor cross section: 1.5 mm<sup>2</sup>
- diameter of the inner conductor: 133× 0.12 mm
- sheath color: white, white
- maximum operating voltage: 50 V
- packaging: 100 m, reel



**S8291** 100/-/-/200  
23 08 215 010 BCYH150W



- conductor cross section: 0.15 mm<sup>2</sup>
- diameter of the inner conductor: 14× 0.12 mm
- sheath color: black, black/red
- maximum operating voltage: 50 V
- packaging: 200 m, reel



**S8130** 200/-/-/800  
23 08 201 550 BCYH015BKR



- conductor cross section: 0.35 mm<sup>2</sup>
- diameter of the inner conductor: 30× 0.12 mm
- sheath color: black, black/red
- maximum operating voltage: 50 V
- packaging: 100 m, reel



**S8230** 100/-/-/400  
23 08 203 550 BCYH035BKR



- conductor cross section: 0.5 mm<sup>2</sup>
- diameter of the inner conductor: 45× 0.12 mm
- sheath color: black, black/red
- maximum operating voltage: 50 V
- packaging: 100 m, reel

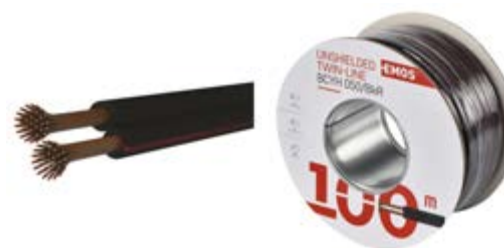

**S8250** 100/-/-/400  
23 08 205 050 BCYH050BKR



- conductor cross section: 0.75 mm<sup>2</sup>
- diameter of the inner conductor: 67× 0.12 mm
- sheath color: black, black/red
- maximum operating voltage: 50 V
- packaging: 100 m, reel



**S8270** 100/-/-/400  
23 08 207 550 BCYH075BKR



- conductor cross section: 1.0 mm<sup>2</sup>
- diameter of the inner conductor: 90× 0.12 mm
- sheath color: black, black/red
- maximum operating voltage: 50 V
- packaging: 100 m, reel



**S8280** 100/-/-/200  
23 08 210 050 BCYH100BKR



- conductor cross section: 1.5 mm<sup>2</sup>
- diameter of the inner conductor: 133× 0.12 mm
- sheath color: black, black/red
- maximum operating voltage: 50 V
- packaging: 100 m, reel



**S8290** 100/-/-/200  
23 08 215 050 BCYH150BKR

- conductor cross section: 0.5 mm<sup>2</sup>
- diameter of the inner conductor: 45× 0.12 mm
- sheath color: black, black/red
- maximum operating voltage: 50 V
- packaging: 100 m, PE foil



**S8253** 100/-/400/800  
23 08 305 050 SPBKR050 ECO

- conductor cross section: 0.75 mm<sup>2</sup>
- diameter of the inner conductor: 67× 0.12 mm
- sheath color: black, black/red
- maximum operating voltage: 50 V
- packaging: 100 m, PE foil



**S8273** 100/-/400/800  
23 08 307 550 SPBKR075 ECO

- conductor cross section: 1.0 mm<sup>2</sup>
- diameter of the inner conductor: 50× 0.16 mm
- sheath color: black, black/red
- maximum operating voltage: 50 V
- packaging: 100 m, PE foil



**S8283** 100/-/-/400  
23 08 310 050 SPBKR100 ECO

- conductor cross section: 1.5 mm<sup>2</sup>
- diameter of the inner conductor: 133× 0.12 mm
- sheath color: black, black/red
- maximum operating voltage: 50 V
- packaging: 100 m, PE foil



**S8293** 100/-/-/400  
23 08 315 050 SPBKR150 ECO



# Coaxial cables

## Coaxial cables 50 Ohm

- line of high-quality coaxial cables for indoor & outdoor use
- quality of CB series coax. cables guarantees long cable life
- purity of copper ensures stability & excellent transmission
- wide range for choosing the right cable for your application
- certified by accredited testing and calibration laboratory
- meet standard ČSN EN 50575 (products' reaction to fire)
- quality of CB series coax. cables guarantees long cable life

coaxial cable type: RG58/U = intended use: short distribution systems, telecommunication antenna connections = UV resistant = suitable for outdoor use = material of the inner conductor: stranded wires, copper (Cu) = diameter of the inner conductor: 17× 0.19 mm = dielectric type, diameter: SPE 3.0 mm = number of shieldings: 1 = material of the shielding: copper clad aluminium (CCA) = number of braiding wires: 112× 0.12 mm = diameter of cable sheath: 5 mm = material of the cable jacket: PVC = color cable sheath > Cable sheath color: black = reaction to the fire: Eca = dangerous substances: none = packaging: 500 m, wooden drum

**S5213**

500/-/-/500

23 05 058 401

RG58U

## Coaxial cables 75 Ohm

- line of high-quality coaxial cables for indoor & outdoor use
- quality of CB series coax. cables guarantees long cable life
- purity of copper ensures stability & excellent transmission
- wide range for choosing the right cable for your application
- certified by accredited testing and calibration laboratory
- meet standard ČSN EN 50575 (products' reaction to fire)
- quality of CB series coax. cables guarantees long cable life

coaxial cable type: CB113 = intended use: tertiary distribution CATV, SAT = material of the inner conductor: copper (Cu) = diameter of the inner conductor: 1.13 mm = dielectric type, diameter: FPE 4.8 mm = number of shieldings: 3 = shielding I. foil: 1× Al/PES = material of the shielding: tinned cooper (CuSn) = number of braiding wires: 144× 0,12 mm = shielding II. foil: Al/PES spiral = diameter of cable sheath: 7,05 mm = material of the cable jacket: PVC = color cable sheath > Cable sheath color: white = reaction to the fire: Eca = dangerous substances: none = packaging: 100 m, reel

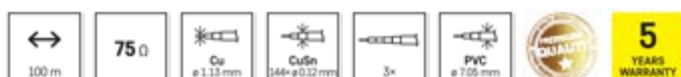
**S5261**

100/-/-/200

23 05 113 000

CB113

coaxial cable type: CB113 = intended use: tertiary distribution CATV, SAT = material of the inner conductor: copper (Cu) = diameter of the inner conductor: 1.13 mm = dielectric type, diameter: FPE 4.8 mm = number of shieldings: 3 = shielding I. foil: 1x Al/PES = material of the shielding: tinned cooper (CuSn) = number of braiding wires: 144x 0,12 mm = shielding II. foil: Al/PES spiral = diameter of cable sheath: 7,05 mm = material of the cable jacket: PVC = color cable sheath > Cable sheath color: white = reaction to the fire: Eca = dangerous substances: none = packaging: 250 m, reel box

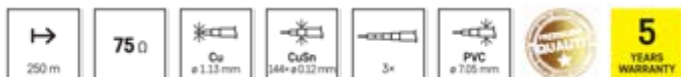

**S5262** 250/-/-250  
23 05 113 002 CB113

coaxial cable type: CB113 = intended use: tertiary distribution CATV, SAT = material of the inner conductor: copper (Cu) = diameter of the inner conductor: 1.13 mm = dielectric type, diameter: FPE 4.8 mm = number of shieldings: 3 = shielding I. foil: 1x Al/PES = material of the shielding: tinned cooper (CuSn) = number of braiding wires: 144x 0,12 mm = shielding II. foil: Al/PES spiral = diameter of cable sheath: 7,05 mm = material of the cable jacket: PVC (HD 624) = color cable sheath > Cable sheath color: white = reaction to the fire: Eca = dangerous substances: none = packaging: 500 m, wooden drum

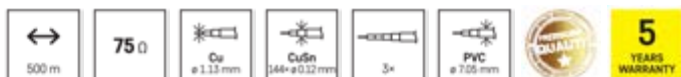

**S5268** 500/-/-500  
23 05 113 003 CB113

coaxial cable type: CB113UV = intended use: outdoor installation, tertiary distribution = UV resistant = suitable for outdoor use = material of the inner conductor: copper (Cu) = diameter of the inner conductor: 1.13 mm = dielectric type, diameter: FPE 4.8 mm = number of shieldings: 3 = shielding I. foil: 1x Al/PES = material of the shielding: tinned cooper (CuSn) = number of braiding wires: 144x 0,12 mm = shielding II. foil: Al/PES spiral = diameter of cable sheath: 7,05 mm = material of the cable jacket: PVC UV resistant = color cable sheath > Cable sheath color: black = reaction to the fire: Eca = dangerous substances: none = packaging: 100 m, reel

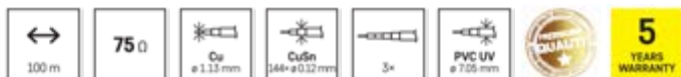

**S5265** 100/-/-200  
23 05 113 500 CB113UV

coaxial cable type: CB113UV = intended use: outdoor installation, tertiary distribution = UV resistant = suitable for outdoor use = material of the inner conductor: copper (Cu) = diameter of the inner conductor: 1.13 mm = dielectric type, diameter: FPE 4.8 mm = number of shieldings: 3 = shielding I. foil: 1x Al/PES = material of the shielding: tinned cooper (CuSn) = number of braiding wires: 144x 0,12 mm = shielding II. foil: Al/PES spiral = diameter of cable sheath: 7,05 mm = material of the cable jacket: PVC UV resistant = color cable sheath > Cable sheath color: black = reaction to the fire: Eca = dangerous substances: none = packaging: 250 m, reel box

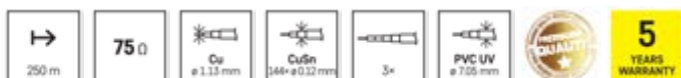

**S5266** 250/-/-250  
23 05 113 502 CB113UV

coaxial cable type: CB100F = intended use: indoor installation, universal cable = material of the inner conductor: copper (Cu) = diameter of the inner conductor: 1.0 mm = dielectric type, diameter: FPE 4.6 mm = number of shieldings: 2 = shielding I. foil: 1x Al/PES = material of the shielding: tinned cooper (CuSn) = number of braiding wires: 48x 0.12 mm = diameter of cable sheath: 6.5 mm = material of the cable jacket: PVC = color cable sheath > Cable sheath color: white = reaction to the fire: Eca = dangerous substances: none = packaging: 100 m, reel

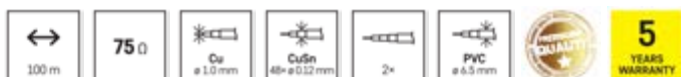

**S5141** 100/-/-200  
23 05 100 200 CB100F

coaxial cable type: CB100F = intended use: indoor installation, universal cable = material of the inner conductor: copper (Cu) = diameter of the inner conductor: 1.0 mm = dielectric type, diameter: FPE 4.6 mm = number of shieldings: 2 = shielding I. foil: 1× Al/PES = material of the shielding: tinned cooper (CuSn) = number of braiding wires: 48× 0.12 mm = diameter of cable sheath: 6.5 mm = material of the cable jacket: PVC = color cable sheath > Cable sheath color: white = reaction to the fire: Eca = dangerous substances: none = packaging: 250 m, reel box

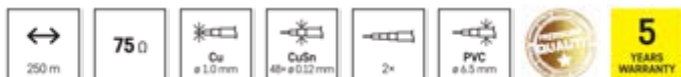

**S5241S** 250/-/-/500  
23 05 100 201 CB100F

coaxial cable type: CB21D = intended use: indoor installation, interference resistant, CLASS A = material of the inner conductor: copper (Cu) = diameter of the inner conductor: 1.1 mm = dielectric type, diameter: FPE 4.8 mm = number of shieldings: 2 = shielding I. foil: 1× Al/PET = material of the shielding: aluminium (Al) = number of braiding wires: 128× 0.12 mm = diameter of cable sheath: 6.8 mm = material of the cable jacket: PVC = color cable sheath > Cable sheath color: white = reaction to the fire: Eca = dangerous substances: none = packaging: 100 m, reel

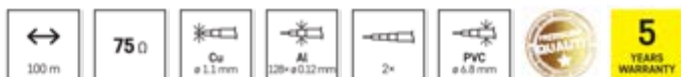

**S5271** 100/-/-/200  
23 05 021 000 CB21D

coaxial cable type: CB21D = intended use: indoor installation, interference resistant, CLASS A = material of the inner conductor: copper (Cu) = diameter of the inner conductor: 1.1 mm = dielectric type, diameter: FPE 4.8 mm = number of shieldings: 2 = shielding I. foil: 1× Al/PET = material of the shielding: aluminium (Al) = number of braiding wires: 128× 0.12 mm = diameter of cable sheath: 6.8 mm = material of the cable jacket: PVC = color cable sheath > Cable sheath color: white = reaction to the fire: Eca = dangerous substances: none = packaging: 500 m, wooden drum



**S5273** 500/-/-/500  
23 05 021 100 CB21D

coaxial cable type: CB50F = intended use: indoor installation, universal cable = material of the inner conductor: copper (Cu) = diameter of the inner conductor: 0.9 mm = dielectric type, diameter: FPE 4.4 mm = number of shieldings: 2 = shielding I. foil: 1× Al = material of the shielding: tinned cooper (CuSn) = number of braiding wires: 32× 0.12 mm = diameter of cable sheath: 6.3 mm = material of the cable jacket: PVC = color cable sheath > Cable sheath color: white = reaction to the fire: Eca = dangerous substances: none = packaging: 100 m, reel



**S5131** 100/-/-/200  
23 05 050 200 CB50F/ RG6 CUSN

coaxial cable type: CB50F = intended use: indoor installation, universal cable = material of the inner conductor: copper (Cu) = diameter of the inner conductor: 0.9 mm = dielectric type, diameter: FPE 4.4 mm = number of shieldings: 2 = shielding I. foil: 1× Al = material of the shielding: tinned cooper (CuSn) = number of braiding wires: 32× 0.12 mm = diameter of cable sheath: 6.3 mm = material of the cable jacket: PVC = color cable sheath > Cable sheath color: white = reaction to the fire: Eca = dangerous substances: none = packaging: 250 m, reel box



**S5231S** 250/-/-/250  
23 05 050 201 CB50F/ RG6 CUSN

coaxial cable type: CB125 = intended use: indoor installation, universal cable = material of the inner conductor: copper (Cu) = diameter of the inner conductor: 1.00 mm = dielectric type, diameter: FPE 4.8 mm = number of shieldings: 2 = shielding I. foil: CCA/PES = material of the shielding: copper clad aluminium (CCA) = number of braiding wires: 64× 0.12 mm = diameter of cable sheath: 6.8 mm = material of the cable jacket: PVC (HD 624) = color cable sheath > Cable sheath color: white = reaction to the fire: Eca = dangerous substances: none = packaging: 100 m, reel



**S5385** 100/-/-/200  
23 05 120 005 CB125

coaxial cable type: CB130 = intended use: indoor installation, universal cable = material of the inner conductor: copper clad steel (CCS) = diameter of the inner conductor: 1.02 mm = dielectric type, diameter: FPE 4.8 mm = number of shieldings: 2 = shielding I. foil: 1× Al/PES = material of the shielding: aluminium (Al) = number of braiding wires: 32× 0.12 mm = diameter of cable sheath: 6.8 mm = material of the cable jacket: PVC = color cable sheath > Cable sheath color: white = reaction to the fire: Eca = dangerous substances: none = packaging: 100 m, reel



**S5381** 100/-/-/200  
23 05 130 000 CB130 / RG6 U

coaxial cable type: CB130 = intended use: indoor installation, universal cable = material of the inner conductor: copper clad steel (CCS) = diameter of the inner conductor: 1.02 mm = dielectric type, diameter: FPE 4.8 mm = number of shieldings: 2 = shielding I. foil: 1× Al/PES = material of the shielding: aluminium (Al) = number of braiding wires: 32× 0.12 mm = diameter of cable sheath: 6.8 mm = material of the cable jacket: PVC = color cable sheath > Cable sheath color: white = reaction to the fire: Eca = dangerous substances: none = packaging: 100 m, PVC foil



**S5381E** 100/-/-/400  
23 05 130 010 CB130 / RG6 U

coaxial cable type: CB115/RG6 CU TRISHIELD = intended use: indoor installation, interference resistant, CLASS A = material of the inner conductor: copper (Cu) = diameter of the inner conductor: 1.02 mm = dielectric type, diameter: FPE 4.8 mm = number of shieldings: 3 = shielding I. foil: 1× Al/PET = material of the shielding: aluminium (Al) = number of braiding wires: 96× 0.12 mm = shielding II. foil: Al/PET = diameter of cable sheath: 6.8 mm = material of the cable jacket: PVC = color cable sheath > Cable sheath color: white = reaction to the fire: Eca = dangerous substances: none = packaging: 100 m, reel

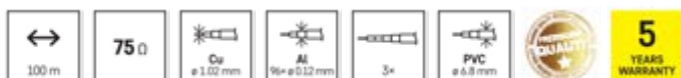

**S5272** 100/-/-/200  
23 05 023 000 CB115/ RG6 CU TRISHIELD

coaxial cable type: CB500 = intended use: CATV distribution = material of the inner conductor: copper (Cu) = diameter of the inner conductor: 0.75 mm = dielectric type, diameter: FPE 3.2 mm = number of shieldings: 3 = shielding I. foil: 1× Al/PES = material of the shielding: tinned cooper (CuSn) = number of braiding wires: 48× 0.12 mm = shielding II. foil: Al/PES = diameter of cable sheath: 5 mm = material of the cable jacket: PVC = color cable sheath > Cable sheath color: white = reaction to the fire: Eca = dangerous substances: none = packaging: 100 m, reel

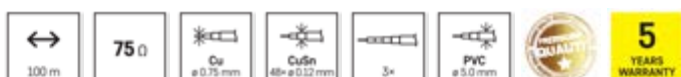

**S5252** 100/-/-/400  
23 05 500 000 CB500



coaxial cable type: CB500 = intended use: terminals for connected users, CATV distribution = material of the inner conductor: copper (Cu) = diameter of the inner conductor: 0.75 mm = dielectric type, diameter: FPE 3.2 mm = number of shieldings: 3 = shielding I. foil: 1× Al/PES = material of the shielding: tinned cooper (CuSn) = number of braiding wires: 48× 0.12 mm = shielding II. foil: Al/PES spiral = diameter of cable sheath: 5 mm = material of the cable jacket: PVC = color cable sheath > Cable sheath color: white = reaction to the fire: Eca = dangerous substances: none = packaging: 250 m, reel box

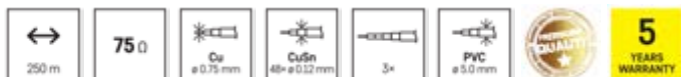

**S5253** 250/-/-/500  
23 05 500 002 CB500

coaxial cable type: CB135 = intended use: indoor installation, interference resistant, CLASS A = material of the inner conductor: copper clad steel (CCS) = diameter of the inner conductor: 1.02 mm = dielectric type, diameter: FPE 4.8 mm = number of shieldings: 3 = shielding I. foil: 1× Al/PES = material of the shielding: aluminium (Al) = number of braiding wires: 64× 0.12 mm = shielding II. foil: Al/PES = diameter of cable sheath: 6.8 mm = material of the cable jacket: PVC = color cable sheath > Cable sheath color: white = reaction to the fire: Eca = dangerous substances: none = packaging: 100 m, reel



**S5382** 100/-/-/200  
23 05 135 000 CB135

coaxial cable type: CB135 = intended use: unit connections, resistant to interference, CLASS A = material of the inner conductor: copper clad steel (CCS) = diameter of the inner conductor: 1.02 mm = dielectric type, diameter: FPE 4.8 mm = number of shieldings: 3 = shielding I. foil: 1× Al/PES = material of the shielding: aluminium (Al) = number of braiding wires: 64× 0.12 mm = shielding II. foil: Al/PES = diameter of cable sheath: 6.8 mm = material of the cable jacket: PVC = color cable sheath > Cable sheath color: white = reaction to the fire: Eca = dangerous substances: none = packaging: 500 m, wooden drum



**S5383** 500/-/-/500  
23 05 135 010 CB135 500M

coaxial cable type: CB130 = intended use: indoor installation = material of the inner conductor: copper clad steel (CCS) = diameter of the inner conductor: 1.02 mm = dielectric type, diameter: FPE 4.8 mm = number of shieldings: 2 = shielding I. foil: 1× Al/PES = material of the shielding: aluminium (Al) = number of braiding wires: 32× 0.12 mm = diameter of cable sheath: 6.8 mm = material of the cable jacket: PVC = color cable sheath > Cable sheath color: white = reaction to the fire: do not subject to CPR = dangerous substances: do not subject to CPR = packaging: 5 m, headercard



**S5373** 1/-/-/16  
23 05 120 010 CB130 / RG6 U

coaxial cable type: CB130 = intended use: indoor installation = material of the inner conductor: copper clad steel (CCS) = diameter of the inner conductor: 1.02 mm = dielectric type, diameter: FPE 4.8 mm = number of shieldings: 2 = shielding I. foil: 1× Al/PES = material of the shielding: aluminium (Al) = number of braiding wires: 32× 0.12 mm = diameter of cable sheath: 6.8 mm = material of the cable jacket: PVC = color cable sheath > Cable sheath color: white = reaction to the fire: do not subject to CPR = dangerous substances: do not subject to CPR = packaging: 10 m, hanging



**S5374** 1/-/-/24  
23 05 120 020 CB130 / RG6 U



coaxial cable type: CB130 = intended use: indoor installation = material of the inner conductor: copper clad steel (CCS) = diameter of the inner conductor: 1.02 mm = dielectric type, diameter: FPE 4.8 mm = number of shieldings: 2 = shielding I. foil: 1x Al/PES = material of the shielding: aluminium (Al) = number of braiding wires: 32x 0.12 mm = diameter of cable sheath: 6.8 mm = material of the cable jacket: PVC = color cable sheath > Cable sheath color: white = reaction to the fire: do not subject to CPR = dangerous substances: do not subject to CPR = packaging: 15 m, headercard



**S5375** 1/-/-16  
23 05 120 030 CB130 / RG6 U

coaxial cable type: CB130 = intended use: indoor installation = material of the inner conductor: copper clad steel (CCS) = diameter of the inner conductor: 1.02 mm = dielectric type, diameter: FPE 4.8 mm = number of shieldings: 2 = shielding I. foil: 1x Al/PES = material of the shielding: aluminium (Al) = number of braiding wires: 32x 0.12 mm = diameter of cable sheath: 6.8 mm = material of the cable jacket: PVC = color cable sheath > Cable sheath color: white = reaction to the fire: do not subject to CPR = dangerous substances: do not subject to CPR = packaging: 20 m, headercard



**S5376** 1/-/-16  
23 05 120 040 CB130 / RG6 U

coaxial cable type: CB113 LSZH = intended use: unit connections, resistant to interference, CLASS A+ = material of the inner conductor: copper (Cu) = diameter of the inner conductor: 1.13 mm = dielectric type, diameter: FPE 4.8 mm = number of shieldings: 3 = shielding I. foil: 1x Al/PES = material of the shielding: tinned cooper (CuSn) = number of braiding wires: 144x 0,12 mm = shielding II. foil: Al/PES spiral = diameter of cable sheath: 7,05 mm = material of the cable jacket: LSZH = color cable sheath > Cable sheath color: white = reaction to the fire: Eca = dangerous substances: none = packaging: 250 m, paper reel box



**S5269** 250/-/-250  
23 05 113 600 CB113 LSZH

coaxial cable type: RG59B/U = intended use: CCTV cabling = UV resistant = material of the inner conductor: copper plated steel = diameter of the inner conductor: 0,58 mm = dielectric type, diameter: SPE 3.7 mm = number of shieldings: 1 = shielding I. foil = material of the shielding: copper clad aluminium (CCA) = number of braiding wires: 128x 0.12 mm = diameter of cable sheath: 6.05 mm = material of the cable jacket: PVC = color cable sheath > Cable sheath color: black = reaction to the fire: Fca = dangerous substances: none = packaging: 500 m, wooden drum



**S5194** 500/-/-500  
23 05 059 009 RG59BU/128SA

coaxial cable type: 3C2V = intended use: replacement of drilling of the walls = UV resistant = suitable for outdoor use = material of the inner conductor: copper (Cu) = diameter of the inner conductor: 0.5 mm = dielectric type, diameter: PE 1.6 mm = number of shieldings: 1 = material of the shielding: copper clad aluminium (CCA) = number of braiding wires: 32x 0.12 mm = diameter of cable sheath: 3 mm = material of the cable jacket: PVC = color cable sheath > Cable sheath color: white = reaction to the fire: do not subject to CPR = dangerous substances: do not subject to CPR = packaging: 1 pc, PE packet







**S5378** 1/-/-1 000  
23 05 032 010 W-CABLE





# Connection AV cables

## AV cables blister





- cables for transmitting audio and video, blister pack
- STEREO: 3.5 mm jack (on 1 or 2 ends), length 1.5–5 m
- USB: 2.0 & 3.0, USB-A, micro, USB-C etc, Quick Charge, 1–2 m
- HDMI: multimedia TV cable, 3D or 4K, various plugs, 1.5–5 m
- SCART: SCART/SCART or SCART/RCA plug, length 1–3 m
- CINCH: 2× or 3× CINCH on both ends, length 1.5–5 m
- COAXIAL: antenna to TV, 1.25–15 m, angle/straight plug

<b>SB3015</b>	1/-/-/12	
23 33 130 150	SB3015	
	 	
8 595025 375766		





connectors: IEC plug – IEC socket = connector type: 2× direct = length: 15 m = number of shieldings: 2 = packaging: 1 pc, blister

<b>SB3103</b>	1/-/-/30	
23 33 131 030	SB3103	
	 	
8 595025 375797		

connectors: IEC plug – IEC socket 90° = connector type: 1× direct, 1× angular = length: 3.5 m = number of shieldings: 2 = packaging: 1 pc, blister

<b>SB3110</b>	1/-/12/24	
23 33 131 100	SB3110	
	 	
8 595025 375827		

connectors: IEC plug – IEC socket 90° = connector type: 1× direct, 1× angular = length: 10 m = number of shieldings: 2 = packaging: 1 pc, blister

<b>SB3115</b>	1/-/-/12	
23 33 131 150	SB3115	
	 	
8 595025 375834		

connectors: IEC plug – IEC socket 90° = connector type: 1× direct, 1× angular = length: 15 m = number of shieldings: 2 = packaging: 1 pc, blister

## AV cables polybag

- cables for transmitting audio and video
- STEREO: 3.5 mm jack (on 1 or 2 ends), length 1.5–5 m
- USB: 2.0 & 3.0, USB-A, micro, USB-C etc, Quick Charge, 1–2 m
- HDMI: multimedia TV cable, 3D or 4K, various plugs, 1.5–10 m
- SCART: SCART/SCART or SCART/RCA plug, length 1–3 m
- CINCH: 2× or 3× CINCH on both ends, length 1.5–5 m
- COAXIAL: connect antenna to TV, 1.25–15 m, angle/straight plug

**SD3010** 1/-/-/30  
23 34 130 100 SD3010



8 592920 002421



connectors: IEC plug – IEC socket = connector type: 2× direct = length: 10 m = number of shieldings: 2 = packaging: 1 pc, packet

## AV cables hanger

- cables for transmitting audio and video
- USB: speed 2.0, with USB-A and micro USB plug, length 1 m
- HDMI: multimedia TV cable, 3D or 4K, 1.5 m, PVC or nylon
- SCART: SCART/SCART plugs, 1.5 m connection cable
- COAXIAL: connect antenna and TV, 1.25–7.5 m, straight plugs

**SL0101** 1/5/20/80  
23 33 001 010 SL0101



8 595025 374868



connectors: A plug – A plug = connector type: 2× direct = length: 1.5 m = support of image resolution: 4K = maximum bit rate: 10.2 Gbit/s = material: PVC = packaging: plastic hanging

**SL0301** 1/5/20/80  
23 33 003 010 SL0301



8 595025 374882



connectors: A plug – A plug = connector type: 2× direct = length: 1.5 m = support of image resolution: 4K = maximum bit rate: 10.2 Gbit/s = material: nylon = packaging: plastic hanging

**SL2001** 1/5/20/80  
23 33 020 010 SL2001







8 595025 380487







length: 1.5 m = connectors: SCART plug – SCART plug = packaging: 1 pc, plastic hanging

## AV cables paper blister





- high quality cables for indoor use
- stable video and audio transmission
- connection to all compatible devices thanks to straight and angled connectors

<b>S10100</b>	1/-/-/20	
23 33 101 011	S10100	
		
8 592920 107850		





- connectors: A plug – A plug
- connector type: 2× direct
- length: 1.5 m
- HDMI version: 2.0
- support of image resolution: 4K
- maximum bit rate: 18 Gbit/s
- material: PVC
- packaging: 1 pc, blister

<b>S10102</b>	1/-/-/20	
23 33 101 013	S10102	
		
8 592920 107904		





- connectors: A plug – C plug
- connector type: 2× direct
- length: 1.5 m
- HDMI version: 2.0
- support of image resolution: 4K
- maximum bit rate: 18 Gbit/s
- material: PVC
- packaging: 1 pc, blister

<b>S10103</b>	1/-/-/20	
23 33 101 014	S10103	
		
8 592920 107911		





- connectors: A plug – D plug
- connector type: 2× direct
- length: 1.5 m
- HDMI version: 2.0
- support of image resolution: 4K
- maximum bit rate: 18 Gbit/s
- material: PVC
- packaging: 1 pc, blister

<b>S10110</b>	1/-/-/20	
23 33 101 015	S10110	
		
8 592920 107928		





- connectors: A plug – A plug
- connector type: 1× direct, 1× angular
- length: 1.5 m
- HDMI version: 2.0
- support of image resolution: 4K
- maximum bit rate: 18 Gbit/s
- material: PVC
- packaging: 1 pc, blister

<b>S10101</b>	1/-/-/20	
23 33 101 016	S10101	
		
8 592920 107959		



- connectors: A plug – A plug
- connector type: 2× direct
- length: 1.5 m
- HDMI version: 2.1
- support of image resolution: 8K
- maximum bit rate: 48 Gbit/s
- material: PVC
- packaging: 1 pc, blister

<b>S10300</b>	1/-/-/20	
23 33 101 031	S10300	
		
8 592920 107867		

- connectors: A plug – A plug
- connector type: 2× direct
- length: 3 m
- HDMI version: 2.0
- support of image resolution: 4K
- maximum bit rate: 18 Gbit/s
- material: PVC
- packaging: 1 pc, blister



<b>S10310</b>	1/-/-/20	
23 33 101 032	S10310	
		
8 592920 107935		

- connectors: A plug – A plug
- connector type: 1× direct, 1× angular
- length: 3 m
- HDMI version: 2.0
- support of image resolution: 4K
- maximum bit rate: 18 Gbit/s
- material: PVC
- packaging: 1 pc, blister

<b>S10500</b>	1/-/-/10	
23 33 101 051	S10500	
		
8 592920 107874		



- connectors: A plug – A plug
- connector type: 2× direct
- length: 5 m
- HDMI version: 2.0
- support of image resolution: 4K
- maximum bit rate: 18 Gbit/s
- material: PVC
- packaging: 1 pc, blister

**S10510** 1/-/-/10  
23 33 101 052 S10510



- connectors: A plug – A plug
- connector type: 1× direct, 1× angular
- length: 5 m
- HDMI version: 2.0
- support of image resolution: 4K
- maximum bit rate: 18 Gbit/s
- material: PVC
- packaging: 1 pc, blister

**S10000** 1/-/-/20  
23 33 101 070 S10000



- connectors: A plug – A plug
- connector type: 2× direct
- length: 0.75 m
- HDMI version: 2.0
- support of image resolution: 4K
- maximum bit rate: 18 Gbit/s
- material: PVC
- packaging: 1 pc, blister

**S11000** 1/-/-/10  
23 33 101 100 S11000



- connectors: A plug – A plug
- connector type: 2× direct
- length: 10 m
- HDMI version: 2.0
- support of image resolution: 4K
- maximum bit rate: 18 Gbit/s
- material: PVC
- packaging: 1 pc, blister

**S30500** 1/-/-/20  
23 33 130 051 S30500



- connectors: IEC plug – IEC socket
- connector type: 2× direct
- length: 5 m
- number of shieldings: 2
- packaging: 1 pc, blister

**S30510** 1/-/-/20  
23 33 130 052 S30510



- connectors: IEC plug – IEC socket
- connector type: 1× direct, 1× angular
- length: 5 m
- number of shieldings: 2
- packaging: 1 pc, blister

**S31000** 1/-/-/20  
23 33 130 101 S31000



- connectors: IEC plug – IEC socket
- connector type: 2× direct
- length: 10 m
- number of shieldings: 2
- packaging: 1 pc, blister

**S31010** 1/-/-/20  
23 33 130 102 S31010



- connectors: IEC plug – IEC socket
- connector type: 1× direct, 1× angular
- length: 10 m
- number of shieldings: 2
- packaging: 1 pc, blister

**S30100** 1/-/-/20  
23 33 130 120 S30100



- connectors: IEC plug – IEC socket
- connector type: 2× direct
- length: 1.25 m
- number of shieldings: 2
- packaging: 1 pc, blister

**S30110** 1/-/-/20  
23 33 130 121 S30110

- connectors: IEC plug – IEC socket
- connector type: 1× direct, 1× angular
- length: 1.25 m
- number of shieldings: 2
- packaging: 1 pc, blister



**S31500** 1/-/-/10  
23 33 130 151 S31500

- connectors: IEC plug – IEC socket
- connector type: 2× direct
- length: 15 m
- number of shieldings: 2
- packaging: 1 pc, blister





**S31510** 1/-/-/12  
23 33 130 152 S31510



- connectors: IEC plug – IEC socket
- connector type: 1× direct, 1× angular
- length: 15 m
- number of shieldings: 2
- packaging: 1 pc, blister

**S30200** 1/-/-/20  
23 33 130 250 S30200



- connectors: IEC plug – IEC socket
- connector type: 2× direct
- length: 2.5 m
- number of shieldings: 2
- packaging: 1 pc, blister

**S30210** 1/-/-/20  
23 33 130 251 S30210



- connectors: IEC plug – IEC socket
- connector type: 1× direct, 1× angular
- length: 2.5 m
- number of shieldings: 2
- packaging: 1 pc, blister

**S30300** 1/-/-/20  
23 33 130 350 S30300



- connectors: IEC plug – IEC socket
- connector type: 2× direct
- length: 3.5 m
- number of shieldings: 2
- packaging: 1 pc, blister

**S30310** 1/-/-/20  
23 33 130 351 S30310



- connectors: IEC plug – IEC socket
- connector type: 1× direct, 1× angular
- length: 3.5 m
- number of shieldings: 2
- packaging: 1 pc, blister

**S30700** 1/-/-/20  
23 33 130 750 S30700



- connectors: IEC plug – IEC socket
- connector type: 2× direct
- length: 7.5 m
- number of shieldings: 2
- packaging: 1 pc, blister

**S30710** 1/-/-/20  
23 33 130 751 S30710



- connectors: IEC plug – IEC socket
- connector type: 1× direct, 1× angular
- length: 7.5 m
- number of shieldings: 2
- packaging: 1 pc, blister

**S70203** 1/-/-/20  
23 33 170 010 S70203



- length: 1 m
- connectors: A plug – micro B plug
- using: charging/data
- USB version: 3.0
- packaging: 1 pc, blister

**S70200** 1/-/-/20  
23 33 170 021 S70200

- length: 2 m
- connectors: A plug – A plug
- using: charging/data
- USB version: 2.0
- packaging: 1 pc, blister

**S70201** 1/-/-/20  
23 33 170 022 S70201

- length: 2 m
- connectors: A plug – A socket
- using: charging/data
- USB version: 2.0
- packaging: 1 pc, blister



**S70202**

1/-/-/20

23 33 170 023

S70202



- length: 2 m
- connectors: A plug – B plug
- using: charging/data
- USB version: 2.0
- packaging: 1 pc, blister

## Smartphone cables

- connection, data and charging cables for phone or tablet
- phone USB cables – micro USB, USB-C & Lightning (for iPhone)
- with 2.0 and 3.0 speed, selected models with Quick Charge
- length 1–2 m, flat & round, classic/reeled, various colours
- universal extension USB cables/splitters, 3 connector types

length: 1 m = connectors: A plug – micro B plug = using: charging/data = USB version: 2.0 = packaging: 1 pc, small box



**SM7004W**

1/-/25/100

23 35 070 410

SM7004W

length: 1 m = connectors: A plug – micro B plug = using: charging/data = USB version: 2.0 = packaging: 1 pc, small box



**SM7004B**

1/-/25/100

23 35 070 420

SM7004B

length: 1 m = connectors: A plug – C plug = using: charging/data = USB version: 2.0 = packaging: 1 pc, small box



**SM7025W**

1/-/25/100

23 35 072 500

SM7025W

length: 1.5 m = connectors: A plug – C plug = using: charging/data = USB version: 2.0 = packaging: 1 pc, small box



**SM7026** 1/-/25/100  
23 35 076 011 SM7026

length: 1 m = connectors: A plug – C plug = using: charging/data = USB version: 2.0 = packaging: 1 pc, small box



**SM7025BL** 1/-/25/100  
23 35 072 501 SM7025BL

length: 1 m = connectors: A plug – C plug = using: charging/data = USB version: 3.1 = packaging: 1 pc, small box



**SM7021BL** 1/-/25/100  
23 35 072 100 SM7021BL

length: 1 m = connectors: C plug – C plug = using: charging/data = USB version: 2.0 = packaging: 1 pc, small box



**SM7027W** 1/-/25/100  
23 35 076 013 SM7027W

length: 1 m = connectors: C plug – C plug = using: charging/data = USB version: 3.1 = packaging: 1 pc, small box



**SM7022BL** 1/-/25/50  
23 35 072 200 SM7022BL

length: 1 m = connectors: C plug – i16P plug = using: charging/data = USB version: 2.0 = packaging: 1 pc, small box



**SM7015W** 1/-/25/100  
23 35 076 014 SM7015W

length: 1 m = connectors: A plug – i16P plug = using: charging/data = USB version: 2.0 = packaging: 1 pc, small box



**SM7013W** 1/-/25/100  
23 35 071 310 SM7013W

connectors: micro B socket – C plug = using: charging/data = USB version: 2.0 = packaging: 2 pcs, small box



**SM7023** 2/-/50/200  
23 35 072 310 SM7023

connectors: 3.5 mm plug – 3.5 mm plug = stereo = length: 1.5 m = packaging: 1 pc, small box



**SM5001** 1/-/-/120  
23 35 050 010 SM5001

connectors: 3.5 mm plug – 3.5 mm socket = stereo = length: 2.5 m = packaging: 1 pc, small box



**SM5102** 1/-/-/120  
23 35 050 020 SM5102

connectors: 3.5 mm plug – 3.5 mm plug = stereo = length: 3 m = packaging: 1 pc, small box



**SM5003** 1/-/-/100  
23 35 050 030 SM5003

connectors: 3.5 mm plug – 3.5 mm socket = stereo = length: 5 m = packaging: 1 pc, small box



**SM5105** 1/-/-/100  
23 35 050 050 SM5105

length: 0.15 m = connectors: A socket – C plug with OTG function = using: data = USB version: 3.0 = packaging: 1 pc, small box



**SM7054** 1/-/25/100  
23 35 076 012 SM7054

length: 2 m = connectors: A plug – mini B plug = using: charging/data = USB version: 2.0 = packaging: 1 pc, small box



**SM7009BL** 1/-/-/120  
23 35 076 020 SM7009BL

length: 2 m = connectors: A plug – micro B plug = using: charging/data = USB version: 2.0 = packaging: 1 pc, small box



**SM7008BL** 1/-/-/120  
23 35 076 021 SM7008BL



## Solid, flexible cables

### Solid cables CYKY-J

- round copper cables for wiring: distribution board to socket
- installation into plaster or cable channel (wall-mounted)
- contain 3 conductors (strands) with 1.5 or 2.5 mm<sup>2</sup> diameter
- tough insulation, black colour
- length: 100 m

#### A3004

100/-/-/100

31 16 300 400



- conductor cross section: 3× 1.5 mm<sup>2</sup>
- designation: CYKY-J
- colour: black
- packaging: 100 m, foil



#### A3010

100/-/-/100

31 16 301 000



- conductor cross section: 3× 2.5 mm<sup>2</sup>
- designation: CYKY-J
- colour: black
- packaging: 100 m, foil



### Flexible cables PVC CYSY

- round copper cables for interiors
- ideal for appliances such as fridges, washing machines etc.
- contain 3 conductors with 1 or 1.5 mm<sup>2</sup> diameter
- soft insulation, white colour
- length: 100 m

#### A3366

100/-/-/100

31 16 336 600



- conductor cross section: 3× 1.0 mm<sup>2</sup>
- designation: H05VV-F
- colour: white
- packaging: 100 m, foil



#### A3369

100/-/-/100

31 16 336 900



- conductor cross section: 3× 1.5 mm<sup>2</sup>
- designation: H05VV-F
- colour: white
- packaging: 100 m, foil



## Solar cables

- designed for fixed photovoltaic installations in indoor and outdoor areas
- tinned OFC copper core
- double jacket made of cross-linked copolymer
- resistant to mechanical damage
- TÜV Rheinland certification

### S9401

500/-/-/500

23 15 094 010

H1Z2Z2 BLACK  
4MM

8 592920 118962



- conductor cross section: 1× 4.0 mm<sup>2</sup>
- designation: H1Z2Z2
- colour: black
- packaging: 500 m, wooden drum

### S9402

500/-/-/500

23 15 094 020

H1Z2Z2 RED 4MM



8 592920 118979



- conductor cross section: 1× 4.0 mm<sup>2</sup>
- designation: H1Z2Z2
- colour: red
- packaging: 500 m, wooden drum

### S9403

500/-/-/500

23 15 094 030

H1Z2Z2 BLACK  
6MM

8 592920 118986



- conductor cross section: 1× 6.0 mm<sup>2</sup>
- designation: H1Z2Z2
- colour: black
- packaging: 500 m, wooden drum

### S9404

500/-/-/500

23 15 094 040

H1Z2Z2 RED 6MM



8 592920 118993



- conductor cross section: 1× 6.0 mm<sup>2</sup>
- designation: H1Z2Z2
- colour: red
- packaging: 500 m, wooden drum

# HF signal receiving components, antennas, small electronic, accessories



## Antennas

### CITY



- for installation in places with sufficient signal quality
- fitted with LTE filter for mobile interference suppression
- selected models include a 5G filter
- reception in horizontal or vertical polarisation

use: indoor = suitable for reception from multiple transmitters = signal reception: FM/DAB/DVB-T/T2 = suitable for receiving Full HD broadcasts = gain control = LTE filter = 5G filter = polarization: horizontal or vertical = frequency bands: FM/VHF/DAB/UHF = frequency range: 47-230 MHz, 470-698 MHz = reception angle: 360° = power supply: DC USB 5 V/550 mA (included) = connectors in the package: 1 pc = connectors: IEC = length of coaxial cable in the package: 1.5 m = dimensions: 128 × 240 × 230 mm = packaging: 1 pc, box



**J0701** 1/-/-/10  
27 02 031 000 RING-C550

use: indoor = suitable for reception from multiple transmitters = signal reception: DAB/DVB-T/T2 = suitable for receiving Full HD broadcasts = LTE filter = 5G filter = polarization: horizontal or vertical = frequency bands: VHF/UHF = frequency range: 174-230 MHz, 470-698 MHz = reception angle: 360° = power supply: DC USB 5 V/550 mA (included) = connectors in the package: 1 pc = connectors: IEC = length of coaxial cable in the package: 2 m = dimensions: 8 × 345 × 77 mm = packaging: 1 pc, box



**J0703** 1/-/-/20  
27 02 033 000 ARCH-C200

use: indoor = suitable for reception from multiple transmitters = signal reception: DAB/DVB-T/T2 = suitable for receiving Full HD broadcasts = gain control = LTE filter = 5G filter = polarization: horizontal or vertical = frequency bands: VHF/DAB/UHF = frequency range: 174-230 MHz, 470-698 MHz = reception angle: 360° = power supply: DC USB 5 V/550 mA (included) = connectors in the package: 1 pc = connectors: IEC = length of coaxial cable in the package: 1.5 m = dimensions: 200 × 40 × 230 mm = packaging: 1 pc, box



**J0704** 1/-/-/10  
27 02 034 000 RING-C500

use: indoor = suitable for reception from multiple transmitters = signal reception: FM/DAB/DVB-T/T2 = suitable for receiving Full HD broadcasts = gain control = LTE filter = 5G filter = polarization: horizontal or vertical = frequency bands: FM/VHF/DAB/UHF = frequency range: 87.5-230 MHz, 470-698 MHz = reception angle: 180° = power supply: DC USB 5 V/550 mA (included) = connectors in the package: 1 pc = connectors: IEC = length of coaxial cable in the package: 1.5 m = dimensions: 110 × 290 × 220 mm = packaging: 1 pc, box



**J0705** 1/-/-/10  
27 02 035 000 ORBI-C200

use: indoor = suitable for reception from multiple transmitters = signal reception: FM/DAB/DVB-T/T2 = suitable for receiving Full HD broadcasts = LTE filter = 5G filter = polarization: horizontal or vertical = frequency bands: FM/VHF/DAB/UHF = frequency range: 87.5-230 MHz, 470-698 MHz = reception angle: 360° = power supply: USB 5 V/200 mA (included) = connectors: IEC = length of coaxial cable in the package: 1.85 m = dimensions: 300 × 80 × 45 mm = packaging: 1 pc, box



**J0708** 1/-/-/20  
27 02 038 000 WOOD-C500

use: indoor = suitable for reception from multiple transmitters = signal reception: DAB/DVB-T/T2 = suitable for receiving Full HD broadcasts = LTE filter = 5G filter = polarization: horizontal or vertical = frequency bands: VHF/UHF = frequency range: 174-230 MHz, 470-698 MHz = reception angle: 180° = power supply: USB 5 V/200 mA (included) = connectors: IEC = dimensions: 1.3 × 228 × 128 mm = packaging: 1 pc, box



**J0709** 1/-/-/22  
27 02 039 000 LEAF-C600

# VILLAGE



- for places with weaker signal (further from transmitter)
- fitted with LTE filter for mobile interference suppression
- can be installed in horizontal or vertical polarisation

use: indoor/outdoor = suitable for long distance reception = suitable for reception from multiple transmitters = signal reception: DVB-T/T2 = suitable for receiving Full HD broadcasts = gain control = LTE filter = 5G filter = polarization: horizontal or vertical = frequency bands: UHF = frequency range: 470–698 MHz = reception angle: 90° = power supply: DC USB 5 V/550 mA (included) = connectors in the package: 2 pc = connectors: F, IEC = length of coaxial cable in the package: 8.5 m = dimensions: 230 × 325 × 20 mm = packaging: 1 pc, box



**J0801** 1/-/-/10  
27 04 310 000 DIO-V750

use: indoor/outdoor = suitable for long distance reception = suitable for reception from multiple transmitters = signal reception: FM/DAB/DVB-T/T2 = suitable for receiving Full HD broadcasts = LTE filter = 5G filter = polarization: horizontal or vertical = frequency bands: FM/VHF/DAB/UHF = frequency range: 87.5–230 MHz, 470–698 MHz = reception angle: 180° = power supply: USB 5 V/200 mA (included) = connectors in the package: 2 pc = connectors: IEC = length of coaxial cable in the package: 5 m = dimensions: 230 × 80 × 120 mm = packaging: 1 pc, box



**J0802** 1/-/-/10  
27 04 320 000 CAMP-V400

use: indoor/outdoor = suitable for long distance reception = suitable for reception from multiple transmitters = signal reception: DVB-T/T2 = suitable for receiving Full HD broadcasts = LTE filter = 5G filter = polarization: horizontal or vertical = frequency bands: UHF = frequency range: 470–698 MHz = number of elements: 10 = reception angle: 30°/40° = power supply: DC USB 5 V/550 mA (included) = connectors: F, IEC = length of coaxial cable in the package: 5 m = dimensions: 315 × 215 × 200 mm = packaging: 1 pc, box



**J0685** 1/-/-/8  
27 02 029 000 EM-D103

use: indoor/outdoor = suitable for long distance reception = suitable for reception from multiple transmitters = signal reception: FM/DAB/DVB-T/T2 = suitable for receiving Full HD broadcasts = LTE filter = 5G filter = polarization: horizontal or vertical = frequency bands: FM/VHF/UHF = frequency range: 47–698 MHz = reception angle: 360° = power supply: USB 5 V/200 mA (included) = connectors: IEC = length of coaxial cable in the package: 5 m = dimensions: 300 × 40 mm = packaging: 1 pc, box



**J0803** 1/-/-/2  
27 04 330 000 MOON-V900





www.emos.eu

Order Code  
Item Number

Packaging  
Type

use: indoor/outdoor = suitable for long distance reception = suitable for reception from multiple transmitters = signal reception: DAB/DVB-T/T2 = suitable for receiving Full HD broadcasts = gain control = LTE filter = 5G filter = polarization: horizontal or vertical = frequency bands: VHF/DAB/UHF = frequency range: 174–230 MHz, 470–698 MHz = reception angle: 180° = power supply: DC USB 5 V/550 mA (included) = connectors in the package: 2 pc = connectors: F, IEC = length of coaxial cable in the package: 8.5 m = dimensions: 40 × 130 × 320 mm = packaging: 1 pc, box



**J0804** 1/-/-2  
27 04 340 000 FLIPP-V200

use: outdoor = suitable for long distance reception = signal reception: DVB-T/T2 = suitable for receiving Full HD broadcasts = LTE filter = 5G filter = polarization: horizontal or vertical = frequency bands: UHF = frequency range: 470–698 MHz = number of elements: 20 = reception angle: 30°/40° = power supply: DC 5–12 V/100 mA (included) = connectors in the package: 1 pc = connectors: F connector = length of coaxial cable in the package: 10 m = dimensions: 400 × 39 × 330 mm = packaging: 1 pc, box



**J0806** 1/-/-1  
27 04 350 000 FISH-V700

## PROFI



- for places with low signal strength (far away from transmitter)
- selected models include a 5G filter
- reception in horizontal or vertical polarisation

- use: outdoor YAGI
- suitable for long distance reception
- signal reception: DVB-T/T2
- suitable for receiving Full HD broadcasts
- LTE filter
- 5G filter
- polarization: horizontal or vertical
- frequency bands: UHF
- frequency range: 470–698 MHz

- number of elements: 16
- reception angle: 38°/80°
- connectors in the package: 1 pc
- connectors: F connector
- dimensions: 790 × 510 × 440 mm
- packaging: 1 pc, box



**J0906** 1/-/-6  
27 04 560 000 EM-P117

- use: outdoor YAGI
- suitable for long distance reception
- signal reception: DVB-T/T2
- suitable for receiving Full HD broadcasts
- LTE filter
- 5G filter
- polarization: horizontal or vertical
- frequency bands: UHF
- frequency range: 470–698 MHz

- number of elements: 27
- reception angle: 38°/80°
- connectors in the package: 1 pc
- connectors: F connector
- dimensions: 1060 × 580 × 600 mm
- packaging: 1 pc, box



**J0907** 1/-/-6  
27 04 570 000 EM-P127

- use: outdoor
- suitable for long distance reception
- suitable for reception from multiple transmitters
- signal reception: DVB-T/T2
- suitable for receiving Full HD broadcasts
- LTE filter
- 5G filter
- polarization: horizontal or vertical
- frequency bands: UHF

- frequency range: 470–698 MHz
- number of elements: 29
- reception angle: 38°/80°
- power supply: passive
- connectors: F connector
- dimensions: 1 150 × 520 × 640 mm
- packaging: 1 pc, box



**J0690** 1/-/-/4  
27 04 039 000 EM-29U5G

- use: outdoor
- suitable for long distance reception
- signal reception: DVB-T/T2
- suitable for receiving Full HD broadcasts
- LTE filter
- 5G filter: no
- polarization: horizontal or vertical
- frequency bands: UHF
- frequency range: 470–790 MHz

- number of elements: 26
- reception angle: 45°/40°
- power supply: passive
- connectors: F connector
- dimensions: 940 × 315 × 38 mm
- packaging: 1 pc, box



**J0669** 1/-/-/1  
27 04 280 010 EM-2845

- use: outdoor
- suitable for long distance reception
- signal reception: DVB-T/T2
- suitable for receiving Full HD broadcasts
- LTE filter
- 5G filter: no
- polarization: horizontal or vertical
- frequency bands: UHF
- frequency range: 470–790 MHz

- number of elements: 16
- reception angle: 34°/26°
- power supply: passive
- connectors: F connector
- dimensions: 1000 × 360 × 340 mm
- packaging: 1 pc, header card



**J0680** 1/-/-/1  
27 04 030 000 EM-116

- use: outdoor logarithmic-periodical
- suitable for long distance reception
- suitable for reception from multiple transmitters
- signal reception: DAB/DVB-T/T2
- suitable for receiving Full HD broadcasts
- LTE filter
- 5G filter: no
- polarization: horizontal or vertical
- frequency bands: VHF/DAB/UHF

- frequency range: 170–790 MHz
- reception angle: 30°/40°
- power supply: 12 V/100 mA (included)
- connectors: F connector
- dimensions: 178 × 560 × 780 mm
- packaging: 1 pc, box



**J0665** 1/-/-/1  
27 03 105 000 EM-025

- use: outdoor logarithmic-periodical
- suitable for long distance reception
- suitable for reception from multiple transmitters
- signal reception: DAB/DVB-T/T2
- suitable for receiving Full HD broadcasts
- LTE filter
- 5G filter: no
- polarization: horizontal or vertical
- frequency bands: VHF/DAB/UHF

- frequency range: 170–790 MHz
- reception angle: 30°/40°
- power supply: 12 V/100 mA (included)
- connectors: F connector
- dimensions: 178 × 560 × 780 mm
- packaging: 1 pc, box



**J0666** 1/-/-/1  
27 03 106 000 EM-030

# TV signal receivers

## TV signal receivers

- certified set-top boxes
- for reception of digital terrestrial DVB-T2 broadcasting
- full support for DVB-T2 in HEVC and H.265 standard
- numerous outlets and plugs: USB, HDMI, SCART, IEC
- recording and playing programmes to/from USB
- timeshift, parent lock, remote control with long range
- multilingual menu, automatic and manual tuning

DVB-T/DVB-T2 : DVB-T2 = connectors: 1× USB 2.0, 1× HDMI 1.4, 1× miniUSB, 1× IEC, 1× SCART = tuner frequency range: 174–230MHz, 474–860 MHz = input level of signal: -75.2 to -23.9 dBm = update via USB: yes = PVR recording function: yes, via USB up to 1 TB = recording format: TS free to be reproduced = file format on USB device: FAT16, FAT32, NTFS = EPG program guide: 7 days = power supply: 220–240 V AC 50/60 Hz = consumption (on/stand-by): 5 W/<1 W = dimensions: 120 × 75 × 25 mm = packaging: 1 pc, box



**J6014** 1/-/-/20  
25 20 236 400 EM190-S HD

## Accessories

**J50988** 1/-/-/200  
25 20 900 088 D.O. EM190 / EM190S



designed for: EM190/EM190S/EM190L = learning function = code remembered after removing the battery = range: 15 m = power source: 2× AAA = dimensions: 175 × 45 × 15 mm = weight: 100 g = packaging: 1 pc, PVC packet

**J50989** 1/-/-/220  
25 20 900 089 D.O. EM190/EM190S S



designed for: EM190/EM190S/EM190L = learning function = code remembered after removing the battery = range: 15 m = power source: 2× AAA = dimensions: 170 × 55 × 20 mm = weight: 100 g = packaging: 1 pc, PVC packet

## Wall sockets

- homologated components for professionals and DIY
- quality materials ensure outstanding technical properties
- designed for processing and transmitting digital signal

- version: terminal
- designation: TV (2) + R (2) + SAT (3)
- terminal attenuation: 3 dB
- connector type: IEC + F (female)
- dimensions: 26 × 60 × 60 mm
- packaging: 1 pc, box



**J0240** 1/-/-/60

25 01 000 300 EU3303

- version: terminal
- designation: TV (2) + R (2) + SAT (3)
- terminal attenuation: 3 dB
- connector type: IEC + F (female)
- dimensions: 26 × 60 × 60 mm
- packaging: 1 pc, box



**J0240E** 1/-/-/100

25 01 000 330 EU3303E

- version: loop-through
- designation: TV (7) + R (7) + SAT (10)
- terminal attenuation: 7 dB
- insertion loss: 3 dB
- connector type: IEC + F (female)
- dimensions: 26 × 60 × 60 mm
- packaging: 1 pc, box



**J0260** 1/-/-/60

25 01 000 400 EU3407

- version: terminal
- designation: TV (3.5) + R (4)
- terminal attenuation: 3 dB
- connector type: IEC
- dimensions: 26 × 60 × 60 mm
- packaging: 1 pc, box



**J0200** 1/-/-/60

25 01 000 100 EU3503

- version: terminal
- designation: TV (1) + R (2)
- terminal attenuation: 1 dB
- connector type: IEC
- dimensions: 26 × 60 × 60 mm
- packaging: 1 pc, box



**J0203**

1/-/-/60

25 01 000 200

EU3601P

- version: loop-through
- designation: TV (7) + R (7)
- terminal attenuation: 7 dB
- insertion loss: 3 dB
- connector type: IEC
- dimensions: 26 × 60 × 60 mm
- packaging: 1 pc, box



**J0220J**

1/-/-/60

25 01 100 100

EU3607

- version: loop-through
- designation: TV (14) + R (14)
- terminal attenuation: 14 dB
- insertion loss: 1.5 dB
- connector type: IEC
- dimensions: 26 × 60 × 60 mm
- packaging: 1 pc, box



**J0222**

1/-/-/60

25 01 100 300

EU3614



# Accessories

## Combiners, splitters

- merge terrestrial and satellite broadcasting signal
- or terrestrial signal from 2 antennas
- divided by enclosure rating: indoor (IP20) or outdoor (IP53)
- split signal to up to 4 outputs (F or IEC connectors)
- selected types feature power pass for DC voltage

- product: signal combiner SAT+TV
- inputs: 2
- outputs: 1
- connectors: IEC
- frequency range: 0.1-1 000 MHz
- insertion loss: 3.5 dB
- power pass
- body material: zinc casting
- working temperature: -10-+65 °C

- using: TV + R
- IP rating: IP20
- dimensions: 17 × 32 × 23 mm
- packaging: 1 pc, PVC packet



**J0197** 1/-/10/200  
25 03 000 100 EU2491

- product: signal combiner SAT+TV
- inputs: 2
- outputs: 1
- suitable for merging of satellite signals
- connectors: F female
- frequency range: 5-2 400 MHz
- insertion loss: 3.5 dB
- power pass: yes, SAT
- body material: zinc casting

- working temperature: -10-+65 °C
- using: TV + R + SAT
- IP rating: IP53
- dimensions: 25 × 35 × 20 mm
- packaging: 1 pc, PVC packet



**J0198** 1/-/10/200  
25 03 000 400 TV+SAT  
COMBINER

- product: splitter
- number of inputs: 1
- number of outputs: 2
- connectors: IEC
- frequency range: 0.1-1 000 MHz
- insertion loss: 3.5 dB
- power pass
- hub body material: zinc casting
- working temperature: -10-+65 °C

- using: TV + R
- IP rating: IP20
- dimensions: 17 × 32 × 23 mm
- packaging: 1 pc, header card



**J0199** 1/-/10/200  
25 04 200 100 EU2501



www.emos.eu

Order Code  
Item Number

Packaging  
Type

- number of inputs: 1
- number of outputs: 2
- connectors: F female
- frequency range: 5-2 400 MHz
- insertion loss: 3.7 dB
- power pass: yes, 2\*
- hub body material: zinc casting
- working temperature: -10--+65 °C
- using: TV + R

- IP rating: IP20
- dimensions: 25 × 35 × 20 mm
- packaging: 1 pc, box



**J0102**

1/-/10/200

25 04 500 110

EM2342

- number of inputs: 1
- number of outputs: 3
- connectors: F female
- frequency range: 5-2 400 MHz
- insertion loss: 6 dB
- power pass: yes, 3\*
- hub body material: zinc casting
- working temperature: -10--+65 °C
- using: TV + R + SAT

- IP rating: IP20
- dimensions: 20 × 56 × 25 mm
- packaging: 1 pc, box



**J0103**

1/-/10/200

25 04 600 110

EM2343

- number of inputs: 1
- number of outputs: 4
- connectors: F female
- frequency range: 5-2 400 MHz
- insertion loss: 7.5 dB
- power pass: yes, 4\*
- hub body material: zinc casting
- working temperature: -10--+65 °C
- using: TV + R + SAT

- IP rating: IP20
- dimensions: 20 × 56 × 25 mm
- packaging: 1 pc, box



**J0104**

1/-/10/200

25 04 700 110

EM2344

## Amplifiers, preamplifiers, LTE filters

- amplification: 20-30 dB, F connectors (in & out), IP45
- built-in LTE filter 790 MHz suppresses mobile interference
- LTE filter can also be purchased extra (for older antennas)

product: antenna preamplifier = inputs: 1 = number of outputs: 1 = frequency range: 5-260 MHz, 470-790 MHz  
 = gain: 25 dB = noise figure: <3.0 dB = connectors: F female = IP rating: IP45 = hole spacing: 27 mm = power supply: 12 V/50 mA = dimensions: 12 × 44 × 40 mm = packaging: 1 pc, PVC packet



**J5802**

1/-/10/200

25 07 100 600

BEN-25



www.emos.eu

Order Code  
Item Number

Packaging  
Type

product: antenna preamplifier = inputs: 1 = number of outputs: 1 = frequency range: 5-260 MHz, 470-790 MHz = gain: 30 dB = noise figure: <3.0 dB = connectors: F female = IP rating: IP45 = hole spacing: 27 mm = power supply: 12 V/50 mA = dimensions: 12 x 44 x 40 mm = packaging: 1 pc, PVC packet



**J5803** 1/-/10/200  
25 07 100 700 BEN-30

product: shielded line amplifier = inputs: 1 = number of outputs: 1 = frequency range: 470-790 MHz = stop band: 790-2 200 MHz = gain: 20 dB = noise figure: <2.0 dB = maximum output signal level: 104 dBµV = connectors: F female = IP rating: IP45 = power supply: 5-12 V DC, 65 mA = dimensions: 20 x 42 mm = packaging: 1 pc, header card



**J5709** 1/-/10/200  
25 08 000 810 AMP-20/5-12

product: shielded line amplifier = inputs: 1 = number of outputs: 1 = frequency range: 470-790 MHz = stop band: 790-2 200 MHz = gain: 30 dB = noise figure: <2.0 dB = maximum output signal level: 104 dBµV = connectors: F female = IP rating: IP45 = power supply: 5-12 V DC, 65 mA = dimensions: 20 x 42 mm = packaging: 1 pc, header card



**J5710** 1/-/10/200  
25 08 000 900 AMP-30 5-12V

product: broadband home amplifier = inputs: 1 = number of outputs: 2 = frequency range: 47-230 MHz, 470-698 MHz = stop band: 400-470 MHz, 699-2 200 MHz = gain: 25 dB = gain control: 0-15 dB = noise figure: <3.0 dB = maximum output signal level: 108 dBµV = connectors: F female = IP rating: IP20 = power supply: 230 V +/-10 %, 50/60 Hz, 3 W = dimensions: 105 x 135 x 40 mm = packaging: 1 pc, box



**J0400** 1/-/-/40  
25 06 000 800 EM440

product: 5G filter = inputs: 1 = number of outputs: 1 = frequency range: 0.3-694 MHz = stop band: 700-2 400 MHz = attenuation in the stop band: >40 dB = connectors: F female = IP rating: IP20 = power pass: yes, 300 mW = dimensions: 16 x 40 mm = packaging: 1 pc, box



**J5711** 1/-/10/200  
25 08 100 100 EM694F



www.emos.eu

Order Code  
Item Number

Packaging  
Type

product: 5G filter = inputs: 1 = number of outputs: 1 = frequency range: 0.3–694 MHz = stop band: 700–2 400 MHz = attenuation in the stop band: >40 dB = connectors: IEC connector = IP rating: IP20 = power pass: yes, 300 mA = dimensions: 16 × 68 mm = packaging: 1 pc, box



<b>J5712</b>	1/-/10/200
25 08 100 200	EM694IEC

## Power supply units for antennas

- for powering antenna preamps and splitters, with duplexer
- output voltage: 12 V/300 mA or 12 V/100 mA, F/IEC connector
- power cable length: 1.5 m

- version: SMPS switched
- designed for: power supply of antenna preamplifiers
- power supply: 110–230 V
- output voltage: 12 V
- output current: 300 mA
- ECO design
- standby power consumption: <0.3 W
- power supply shunt
- input connector of the power injector: F connector

- output connector of the power injector: IEC
- power cable: 1.5 m
- dimensions: 70 × 57 × 23 mm
- packaging: 1 pc, box



<b>J5810</b>	1/-/-/80
17 02 010 035	EM-12SP

- version: SMPS switched
- designed for: power supply of antenna preamplifiers
- power supply: 110–230 V
- output voltage: 12 V
- output current: 100 mA
- ECO design
- standby power consumption: <0.3 W
- power supply shunt
- input connector of the power injector: F connector



- output connector of the power injector: F connector
- power cable: 1.5 m
- dimensions: 24 × 68 × 35 mm
- packaging: 1 pc, box





<b>J58133</b>	1/-/-/70
17 02 010 034	BEN-712A



## Holders for satellite, terrestrial antennas



- mounts for TV, Internet and parabolic satellite antennas
- for mounting onto a wall, mast or balcony railing
- length: 250–500 mm, diameter: 28–40 mm, height: 150–630 mm
- galvanised surface protects against rust



<b>J60030</b>	1/-/-/1	
25 21 000 030	V30G	
		
<p>holder type: holder with crossing for the antennas = length from the base: 250 mm = finishing of the surface: galvanization = pipe diameter: 28 mm = height: 630 mm = mounting adapted to: wall = packaging: 1 pc, no packaging</p>		

<b>J60110</b>	1/-/-/100	
25 21 000 110	V110G	
		
<p>holder type: holder basic = length from the base: 250 mm = finishing of the surface: galvanization = pipe diameter: 28 mm = height: 130 mm = mounting adapted to: wall = packaging: 1 pc, no packaging</p>		

<b>J60120</b>	1/-/-/1	
25 21 000 120	V120G	
		
<p>holder type: holder with crossing = length from the base: 250 mm = finishing of the surface: galvanization = pipe diameter: 40 mm = height: 150 mm = mounting adapted to: wall = packaging: 1 pc, no packaging</p>		

<b>J60130</b>	1/-/-/1	
25 21 000 130	V130G	
		
<p>holder type: holder with crossing = length from the base: 350 mm = finishing of the surface: galvanization = pipe diameter: 40 mm = height: 150 mm = mounting adapted to: wall = packaging: 1 pc, no packaging</p>		

<b>J60140</b>	1/-/-/1	
25 21 000 140	V140G	
		
<p>holder type: holder with crossing = length from the base: 500 mm = finishing of the surface: galvanization = pipe diameter: 40 mm = height: 150 mm = mounting adapted to: wall = packaging: 1 pc, no packaging</p>		

<b>J60170</b>	1/-/-/1	
25 21 000 170	V170G	
		
<p>holder type: pole holder = length from the base: 350 mm = finishing of the surface: galvanization = pipe diameter: 40 mm = height: 150 mm = mounting adapted to: mast = packaging: 1 pc, no packaging</p>		



# ZigBee GoSmart



- To expand the smart home with additional sensors and products
- Allows automation settings for added sensors and products
- Communication protocols Wi-Fi/Zigbee 3.0/BLE/SigMesh
- Compatibility with EMOS GoSmart products and TUYA devices



- product: IP gateway
  - connectivity: 2.4 GHz WIFI
  - maximum number of connected clients: 50
  - compatibility: EMOS GoSmart, TUYA, LIDL, Smartlife
  - protocol: Wi-Fi/Zigbee 3.0/BLE/SigMesh
  - pairing: automatic, manual
  - use: automation
  - number of control buttons: 1
  - power supply: 5 V DC/1.0 A
- supported OS: Android, iOS



<b>H5001</b>	1/-/-120
30 69 050 010	IP-1000Z

- product: ZigBee repeater
- connectivity: 2.4 GHz WIFI
- compatibility: EMOS GoSmart, TUYA, LIDL, Smartlife
- protocol: Zigbee 3.0
- pairing: automatic, manual
- use: automation
- power supply: 5 V DC/1.0 A
- supported OS: Android, iOS



<b>H5022</b>	1/-/-60
30 69 052 030	IP-2213Z





# Videophones, doorbells

## Home videophones, sets

### Home videophones

- part of modern household security
- kit consists of camera and monitor with intuitive controls
- expandable with extra inputs, screens or CCTV cameras
- gate control from inside the house, touch/mechanical keys
- higher class videophones also w/ photographic memory/Wi-Fi
- white or infrared camera illumination ensures night vision
- colour display, up to 16 ringtones, power supply included

product: video set = screen size: 7" = possibility to record = lock control = gate control = intercom = power supply for the screen: 12 V DC (included) = optional connection of CCTV camera = monitor size: 175 × 125 × 20 mm = dimensions of the camera unit: 135 × 50 × 25 mm = camera viewing angle: 160° = packaging: 1 pc, box



Resolution 1080p	Video guard	Snapshot	160°	Door/Gate control	Infrared night vision	7" LCD colour	Card slot	4+2 Wires	EASY TO INSTALL	
------------------	-------------	----------	------	-------------------	-----------------------	---------------	-----------	-----------	-----------------	--

**H3010** 1/-/-/6  
30 10 003 010 EM-10AHD

screen size: 7" = lock and gate control = intercom = power supply for the monitor: 12 V DC (included) = recommended camera unit: H3016, H3017, H3018 = monitor size: 175 × 125 × 20 mm = packaging: 1 pc, box



Resolution 1080p	Video guard	Snapshot	Door/Gate control	7" LCD colour	Record	4+2 Wires	EASY TO INSTALL	
------------------	-------------	----------	-------------------	---------------	--------	-----------	-----------------	--

**H3015** 1/-/-/21  
30 10 003 015 EM-10AHD

product: camera unit with RFID = number of buttons on the camera unit: 1 = power supply: via monitor = number of wires (monitor/lock/power supply): 4/2/0 = dimensions of the camera unit: 131 × 47 × 18 mm = IP rating: IP44 = camera viewing angle: 160° = door lock control = installation: surface = packaging: 1 pc, box



**H3016** 1/-/-20  
30 10 003 016 EM-10AHD RF-1

product: camera unit with RFID = number of buttons on the camera unit: 2 = power supply: via monitor = number of wires (monitor/lock/power supply): 2× 4/2/0 = dimensions of the camera unit: 131 × 47 × 18 mm = IP rating: IP44 = camera viewing angle: 160° = door lock control = installation: surface = packaging: 1 pc, box



**H3017** 1/-/-20  
30 10 003 017 EM-10AHD RF-2

product: camera unit with RFID = number of buttons on the camera unit: 4 = power supply: via monitor = number of wires (monitor/lock/power supply): 4× 4/2/0 = dimensions of the camera unit: 131 × 47 × 18 mm = IP rating: IP44 = camera viewing angle: 160° = door lock control = installation: surface = packaging: 1 pc, box



**H3018** 1/-/-20  
30 10 003 018 EM-10AHD RF-4

product: camera unit = number of buttons on the camera unit: 1 = power supply: via monitor = number of wires (monitor/lock/power supply): 4+0+0 = dimensions of the camera unit: 49 × 132 × 20 mm = IP rating: IP65 = camera viewing angle: 160° horizontally a 130° vertically = door lock control = installation: surface = packaging: 1 pc, box



**H3019** 1/-/-20  
30 10 003 019 EM-10AHD KEY-1

product: video set = screen size: 7" = lock control = gate control = power supply for the screen: 14.5 V DC (included) = monitor size: 152 × 215 × 18 mm = dimensions of the camera unit: 141 × 63 × 40 mm = camera viewing angle: 80° = packaging: 1 pc, box



**H2050** 1/-/-8  
30 10 002 050 H2050

product: video set = screen size: 7" = lock control = gate control = intercom = power supply for the screen: 12 V DC (included) = optional connection of CCTV camera = monitor size: 233 × 23 × 160 mm = dimensions of the camera unit: 64 × 46 × 145 mm = camera viewing angle: 80° = packaging: 1 pc, box



**H2017** 1/-/-/6  
30 10 002 017 EM-07HD

product: sudio porter set = lock and gate control: door lock control = power supply: 12 V DC (included) = number of wires (monitor/lock/gate): 2+2+0 = dimensions of the door station: 35 × 65 × 145 mm = handset dimension: 75 × 93 × 225 mm = packaging: 1 pc, box



**H1085** 1/-/-/10  
30 10 000 291 H1085

product: sudio porter set = lock and gate control: door lock control = power supply: 12 V DC = number of wires (monitor/lock/gate): 3+2+0 = dimensions of the door station: 116 × 199 × 40 mm = handset dimension: 75 × 93 × 225 mm = packaging: 1 pc, box



**H1086** 1/-/-/10  
30 10 000 292 H1086

product: additional camera unit = number of buttons on the camera unit: 1 = power supply: via monitor = number of wires (monitor/lock/power supply): 4/2/0 = dimensions of the camera unit: 64 × 46 × 145 mm = IP rating: IP44 = camera viewing angle: 80° = door lock control = installation: surface = packaging: 1 pc, box

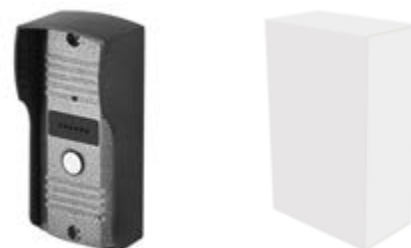

**H1141** 1/-/-/20  
30 10 001 151 EM-07HD C-01

# Videophones and video doorbells GoSmart



- Perfect access control for commercial and private properties
- Unusual activity alerts sent to mobile devices
- Two-way communication with the visitor without opening the door
- Automatic video and audio recording when motion is detected
- Night vision for perfect images in all lighting conditions
- Compatibility with EMOS GoSmart products and TUYA devices
- Voice control with Google Assistant and Amazon Alexa

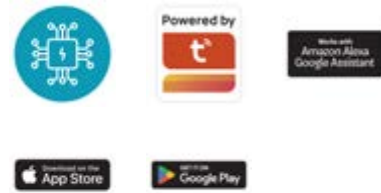

product: doorphone set with WiFi = screen size: 7" = possibility to record = lock control = gate control = intercom = power supply for the screen: 12 V DC (included) = optional connection of CCTV camera = monitor size: 175 × 118 × 25 mm = dimensions of the camera unit: 142 × 44 × 21 mm = camera viewing angle: 160° = packaging: 1 pc, box = supported OS: Android, iOS = compatibility: EMOS GoSmart, TUYA, LIDL, Smartlife, open system = protocol: Wi-fi = connectivity: 2.4 GHz WIFI = voice communication: two-way



**H4020** 1/-/-4  
30 10 040 200 IP-750A

product: video phone = screen size: 7" = lock and gate control = intercom = power supply for the monitor: 12 V DC (included) = recommended camera unit: H3016, H3017, H3018, H3019 = monitor size: 145 × 205 × 12 mm = packaging: 1 pc, box



**H4021** 1/-/-6  
30 10 040 210 IP-750B

lock control = additional indoor bell = camera viewing angle: 110° = camera resolution: 1 920 × 1 080 = motion detection = IR CUT = siren = supported OS: Android, iOS = compatibility: EMOS GoSmart, TUYA, LIDL, Smartlife, open system = protocol: Wi-Fi = transmission frequency: 2.4 GHz WIFI = SD card storage = cloud storage = anti-theft protection = control by voice assistants = voice communication: two-way = notifications to the mobile app = WebRTC function



**H4030** 1/-/-8  
30 10 040 300 IP-09D DC

lock control = additional indoor bell = camera viewing angle: 110° = camera resolution: 1 920 × 1 080 = motion detection = IR CUT = siren = supported OS: Android, iOS = compatibility: EMOS GoSmart, TUYA, LIDL, Smartlife, open system = protocol: Wi-Fi = transmission frequency: 2.4 GHz WIFI = SD card storage = cloud storage = anti-theft protection = control by voice assistants = voice communication: two-way = notifications to the mobile app = WebRTC function



**H4031** 1/-/-12  
30 10 040 310 IP-09C



additional indoor bell = camera viewing angle: 130° = camera resolution: 1 920 × 1 080 = motion detection = IR CUT = supported OS: Android, iOS = compatibility: EMOS GoSmart, TUYA, LIDL, Smartlife, open system = protocol: Wi-Fi = transmission frequency: 2.4 GHz WIFI = SD card storage = cloud storage = anti-theft protection = control by voice assistants = voice communication: two-way = notifications to the mobile app = WebRTC function



											<b>H4032</b>	1/-/-10
										8 592920 118177	30 10 040 320	IP-15S

## Accessories for videophones

- electrical door controls are a key part of security systems
- often complemented by code keypads or fingerprint readers
- automatically open door lock after access verification
- keypad w/ 2 relays, built-in RFID fob reader also available
- memory capacity of up to 1 000 codes

<b>H8013</b>	1/100/-/700	
30 80 000 013	H8013	
8 595025 385802		

product: RF tag = dimensions: 28 × 7 mm = packaging: 1 pc, packet = frequency: 125 kHz

<b>C0024</b>	1/-/-/30	
28 04 000 013	C0024	
4 042203 778382		

product: lock = type: with mechanical unblocking for constant entry - OPEN position = power supply: 12 V AC/DC (not included) = dimensions: 25 × 28 × 250 mm = packaging: 1 pc, box

<b>C0025</b>	1/-/-/30	
28 04 000 014	C0025	
4 042203 778306		

product: lock = type: with a time pin, after the electric impulse position OPENED, after passing through the door position CLOSED = power supply: 12 V AC/DC (not included) = dimensions: 25 × 28 × 250 mm = packaging: 1 pc, box

<b>C0030</b>	1/-/-/12	
28 04 000 030	EM-0280A	
8 592920 128886		

product: door lock = type: EM-0280A = power supply: 12 V DC (není součástí balení) = dimensions: 250 × 25 × 32 mm = packaging: 1 pc, box

<b>H5023</b>	1/-/-/18	
30 69 050 230	IP-006AX	
8 592920 128862		

product: keyboard RFID, TUYA = number of switching relays: 1 = number of codes: up to 1 000 = power source: 12 V AC/DC (not included) = dimensions: 23 × 78 × 115 mm = packaging: 1 pc, box = frequency: 125 kHz = supported OS: Android, iOS = compatibility: EMOS GoSmart, TUYA, LIDL, Smartlife, open system = protocol: Wi-Fi = transmission frequency: 2.4 GHz Wi-Fi = cloud storage

<b>H7009</b>	1/-/-/50	
30 70 000 009	H7009	
8 592920 110584		

max. output total: 12 V/5 A = input voltage: 100–240 V~, 47–63 Hz = protection against overload, overvoltage and short circuit = designed for: universal = LED indicators = output voltage: 12 V DC = output current: max. 5 000 mA = power supply type: no cable = dimensions: 77 × 55 × 92 mm = packaging: 1 pc, paper box

# Cameras, Surveillance

## GoSmart Cameras



- For keeping people safe and protecting the interiors of homes
- Surveillance of exteriors of commercial and private buildings
- Alerts of unusual activity sent to mobile devices
- Two-way voice communication
- Automatic video and audio recording when motion is detected
- Connection to home network via WIFI protocol
- Compatibility with EMOS GoSmart products and TUYA devices
- Voice control with Google Assistant and Amazon Alexa



- automatic image saving
- setting the detection area
- night vision
- camera viewing angle: 100°
- IP rating: IP20
- camera resolution: 1 920 × 1 080
- motion detection
- sound detection
- compatibility: EMOS GoSmart, TUYA, LIDL, Smartlife
- protocol: Wi-Fi
- transmission frequency: 2.4 GHz WIFI
- voice communication: two-way
- motion tracking
- motorised rotation
- motion detection angle: 100°
- motion detection range: 10 meters



**H4051** 1/-/-12  
30 24 040 510 IP-100 CUBE

- automatic image saving
- setting the detection area
- night vision
- camera viewing angle: 100°
- IP rating: IP20
- camera resolution: 2 304 × 1 296
- motion detection
- sound detection
- compatibility: EMOS GoSmart, TUYA, LIDL, Smartlife
- protocol: Wi-Fi
- transmission frequency: 2.4 GHz WIFI
- voice communication: two-way
- motion tracking
- motorised rotation
- motion detection angle: 100°
- motion detection range: 10 meters
- human body recognition



**H4052** 1/-/-6  
30 24 040 520 IP-500 GUARD

- automatic image saving
- night vision
- camera viewing angle: 110°
- IP rating: IP55
- camera resolution: 1 920 × 1 080
- motion detection
- compatibility: EMOS GoSmart, TUYA, LIDL, Smartlife
- protocol: Wi-Fi
- transmission frequency: 2.4 GHz WIFI
- voice communication: two-way
- motion detection angle: 120°
- motion detection range: 10 meters
- human body recognition



**H4056** 1/-/-5  
30 24 040 560 IP-600 EYE

- automatic image saving
- setting the detection area
- night vision
- camera viewing angle: 110°
- IP rating: IP65
- camera resolution: 2 616 × 1 958
- motion detection
- sound detection
- compatibility: EMOS GoSmart, TUYA, LIDL, Smartlife

- protocol: Wi-Fi
- transmission frequency: 2.4 GHz WIFI
- voice communication: two-way
- motion tracking
- motorised rotation
- motion detection angle: 110°
- motion detection range: 10 meters
- human body recognition



**H4057** 1/-/-/4  
30 24 040 570 IP-800 WASP

- automatic image saving
- setting the detection area
- night vision: yes, 4× IR LED + white LED
- camera viewing angle: 105°
- IP rating: IP65
- camera resolution: 2 048 × 1 536
- motion detection
- compatibility: EMOS GoSmart, TUYA, LIDL, Smartlife
- protocol: 4G, LTE

- transmission frequency: LTE
- voice communication: two-way
- motorised rotation
- motion detection angle: 120°
- motion detection range: 10 meters
- human body recognition



**H4058** 1/-/-/4  
30 24 040 580 IP-6000 OWL

- automatic image saving
- setting the detection area
- night vision
- camera viewing angle: 100°
- IP rating: IP20
- camera resolution: 2 304 × 1 296
- motion detection
- sound detection
- compatibility: EMOS GoSmart, TUYA, LIDL, Smartlife

- protocol: Wi-Fi
- transmission frequency: 2.4 GHz WIFI
- voice communication: two-way
- motion tracking
- motorised rotation
- motion detection angle: 100°
- motion detection range: 10 meters



**H4061** 1/-/-/12  
30 24 040 610 IP-110 CUBEV2

- automatic image saving
- setting the detection area
- night vision: yes, 9× IR LED 850 nm
- camera viewing angle: 130°
- IP rating: IP65
- camera resolution: 2 592 × 1 944
- motion detection
- compatibility: EMOS GoSmart, TUYA, LIDL, Smartlife
- protocol: Wi-Fi

- transmission frequency: 2.4 GHz WIFI
- voice communication: two-way
- motion detection angle: 120°
- motion detection range: 9 metres
- human body recognition



**H4063** 1/-/-/14  
30 24 040 630 IP-210 SNAPV2

- automatic image saving
- setting the detection area
- night vision: yes, 4× IR LED + white LED
- camera viewing angle: 130°
- IP rating: IP65
- camera resolution: 2 304 × 1 296
- motion detection
- compatibility: EMOS GoSmart, TUYA, LIDL, Smartlife
- protocol: Wi-Fi

- transmission frequency: 2.4 GHz WIFI
- voice communication: two-way
- motion tracking
- motorised rotation
- motion detection angle: 120°
- motion detection range: 10 meters



**H4064** 1/-/-/4  
30 24 040 640 IP-310 TORCHV2 WHITE

- automatic image saving
- setting the detection area
- night vision: yes, 4× IR LED + white LED
- camera viewing angle: 130°
- IP rating: IP65
- camera resolution: 2 304 × 1 296
- motion detection
- compatibility: EMOS GoSmart, TUYA, LIDL, Smartlife
- protocol: Wi-Fi
- transmission frequency: 2.4 GHz WIFI
- voice communication: two-way
- motion tracking
- motorised rotation
- motion detection angle: 120°
- motion detection range: 10 meters



**H4065** 1/-/-/4  
30 24 040 650 IP-310 TORCHV2  
BLACK

## Doorbells

### Wireless doorbells

- EMOS doorbells have a battery- or mains-powered receiver
- paired from production/paired by user with ease in seconds
- new models with signal repeater – unlimited range
- with 1 or 2 waterproof buttons, more buttons can be added
- volume controls, optical signalisation, up to 52 ringtones

- reach of the button: 150 m
- number of melodies: 10
- pairing method: automatic pairing – self-learning
- special functions: battery-free button
- optical signaling on the doorbell
- optical signaling on the button
- maximum ringing volume: 110 dB
- option to add another button: yes, max. 8
- number of buttons in a package: 1 pc
- extra (spare) button: P5750T
- waterproof button: IP44
- power button: unpowered
- number of receivers in a package: 1 pc
- volume control: yes, 5 levels
- power supply of the main unit: 230 V AC



**P5750** 1/-/-/14  
34 02 118 000 P5750

- reach of the button: 150 m
- number of melodies: 10
- pairing method: automatic pairing – self-learning
- special functions: battery-free button
- optical signaling on the doorbell
- optical signaling on the button
- maximum ringing volume: 110 dB
- option to add another button: yes, max. 8
- number of buttons in a package: 2 pcs
- extra (spare) button: P5750T
- waterproof button: IP44
- power button: unpowered
- number of receivers in a package: 1 pc
- volume control: yes, 5 levels
- power supply of the main unit: 230 V AC



**P5750.2T** 1/-/-/8  
34 02 119 000 P5750.2T



- reach of the button: 150 m
- number of melodies: 10
- pairing method: automatic pairing – self-learning
- special functions: battery-free button
- optical signaling on the doorbell
- optical signaling on the button
- maximum ringing volume: 110 dB
- option to add another button: yes, max. 8
- number of buttons in a package: 1 pc
- extra (spare) button: P5750T
- waterproof button: IP44
- power button: unpowered
- number of receivers in a package: 2 pcs
- volume control: yes, 5 levels
- power supply of the main unit: 230 V AC



**P5750.2R**

1/-/-/8

34 02 120 000

P5750.2R



- reach of the button: 120 m
- number of melodies: 16
- pairing method: automatic pairing – self-learning
- special functions: USB output – 2 A, repeater functi
- optical signaling on the doorbell
- optical signaling on the button
- maximum ringing volume: 85 dB
- option to add another button: yes, max. 8
- number of buttons in a package: 1 pc
- extra (spare) button: P5760T
- waterproof button: IP44
- power button: 1× 3 V CR2032 (included)
- number of receivers in a package: 1 pc
- volume control: yes, 5 levels
- power supply of the main unit: 230 V AC



**P5760**

1/-/5/10

34 02 060 000

P5760



- reach of the button: 120 m
- number of melodies: 16
- pairing method: automatic pairing – self-learning
- special functions: repeater function – allows extend
- optical signaling on the doorbell
- optical signaling on the button
- maximum ringing volume: 85 dB
- option to add another button: yes, max. 8
- number of buttons in a package: 1 pc
- extra (spare) button: P5760T
- waterproof button: IP44
- power button: 1× 3 V CR2032 (included)
- number of receivers in a package: 1 pc
- volume control: yes, 5 levels
- power supply of the main unit: 3× 1.5 V AA (not inclu



**P5763**

1/-/5/10

34 02 060 001

P5763



- reach of the button: 120 m
- number of melodies: 16
- pairing method: automatic pairing – self-learning
- special functions: repeater function – allows extend
- optical signaling on the doorbell
- optical signaling on the button
- maximum ringing volume: 85 dB
- option to add another button: yes, max. 8
- extra (spare) button: P5760T
- power button: 1× 3 V CR2032 (included)
- number of receivers in a package: 1 pc
- volume control: yes, 5 levels
- power supply of the main unit: 3× 1.5 V AA (not inclu



**P5763R**

1/-/5/15

34 02 063 000

P5763R



- reach of the button: 150 m
- number of melodies: 36
- pairing method: automatic pairing – self-learning
- optical signaling on the button
- maximum ringing volume: 85 dB
- option to add another button: yes, max. 6
- number of buttons in a package: 1 pc
- extra (spare) button: P5727T
- waterproof button: IP44
- power button: 1× 3 V CR2032 (included)
- number of receivers in a package: 1 pc
- volume control: yes, 4 levels
- power supply of the main unit: 230 V AC



**P5727**

1/-/-/8

34 02 025 000

P5727





- reach of the button: 60 m
- number of melodies: 1
- pairing method: automatic pairing – self-learning
- optical signaling on the doorbell
- optical signaling on the button
- maximum ringing volume: 75 dB
- option to add another button: yes, max. 8
- number of buttons in a package: 1 pc
- extra (spare) button: P5723T

- waterproof button: IP44
- power button: 1× 3 V CR2032 (included)
- number of receivers in a package: 1 pc
- power supply of the main unit: 230 V AC



**P5705** 1/-/4/12  
34 02 005 000 98080S



- reach of the button: 100 m
- number of melodies: 16
- pairing method: automatic pairing – self-learning
- optical signaling on the doorbell
- optical signaling on the button
- maximum ringing volume: 80 dB
- option to add another button: yes, max. 8
- number of buttons in a package: 1 pc
- extra (spare) button: P5723T

- waterproof button: IP44
- power button: 1× 3 V CR2032 (included)
- number of receivers in a package: 1 pc
- volume control
- power supply of the main unit: 3× 1.5 V AA (not inclu)



**P5712** 1/-/5/40  
34 02 012 000 9810S



- reach of the button: 100 m
- number of melodies: 36
- pairing method: automatic pairing – self-learning
- optical signaling on the button
- maximum ringing volume: 75 dB
- option to add another button: yes, max. 8
- number of buttons in a package: 1 pc
- extra (spare) button: P5723T
- waterproof button: IP44

- power button: 1× 3 V CR2032 (included)
- number of receivers in a package: 1 pc
- power supply of the main unit: 3× 1.5 V AA (not inclu)



**P5723** 1/3/-/48  
34 02 107 000 9809S



- reach of the button: 180 m
- number of melodies: 52
- pairing method: automatic pairing – self-learning
- optical signaling on the doorbell
- optical signaling on the button
- maximum ringing volume: 90 dB
- option to add another button: yes, max. 6
- number of buttons in a package: 1 pc
- extra (spare) button: P5728T

- waterproof button: IP56
- power button: 1× 12 V A23 (included)
- number of receivers in a package: 1 pc
- volume control: yes, 5 levels
- power supply of the main unit: 3× 1.5 V AAA (not inc)



**P5728** 1/-/-/30  
34 02 043 000 P5728



- reach of the button: 180 m
- number of melodies: 52
- pairing method: automatic pairing – self-learning
- optical signaling on the doorbell
- optical signaling on the button
- maximum ringing volume: 90 dB
- option to add another button: yes, max. 6
- number of buttons in a package: 1 pc
- extra (spare) button: P5728T

- waterproof button: IP56
- power button: 1× 12 V A23 (included)
- number of receivers in a package: 2 pcs
- volume control: yes, 5 levels
- power supply of the main unit: 3× 1.5 V AAA (not inc)



**P5730** 1/-/-/12  
34 02 115 000 P5730



- reach of the button: 180 m
- number of melodies: 36
- pairing method: automatic pairing – self-learning
- special functions: battery-free button
- optical signaling on the doorbell
- optical signaling on the button
- maximum ringing volume: 90 dB
- option to add another button: yes, max. 6
- number of buttons in a package: 1 pc

- extra (spare) button: P5729T
- waterproof button: IP44
- power button: unpowered
- number of receivers in a package: 1 pc
- volume control: yes, 4 levels
- power supply of the main unit: 230 V AC



**P5729**  
34 02 044 000

1/-/-14  
P5729



- reach of the button: 180 m
- number of melodies: 36
- pairing method: automatic pairing – self-learning
- special functions: battery-free button
- optical signaling on the doorbell
- optical signaling on the button
- maximum ringing volume: 90 dB
- option to add another button: yes, max. 6
- number of buttons in a package: 1 pc

- extra (spare) button: P5729T
- waterproof button: IP44
- power button: unpowered
- number of receivers in a package: 2 pcs
- volume control: yes, 4 levels
- power supply of the main unit: 230 V AC



**P5731**  
34 02 116 000

1/-/-8  
P5731



- reach of the button: 180 m
- number of melodies: 36
- pairing method: automatic pairing – self-learning
- special functions: battery-free button
- optical signaling on the doorbell
- optical signaling on the button
- maximum ringing volume: 90 dB
- option to add another button: yes, max. 6
- number of buttons in a package: 1 pc

- extra (spare) button: P5729T
- waterproof button: IP44
- power button: unpowered
- number of receivers in a package: 1 pc
- volume control: yes, 4 levels
- power supply of the main unit: 230 V AC



**P5729B**  
34 02 121 000

1/-/-14  
P5729B



- reach of the button: 150 m
- number of melodies: 36
- pairing method: automatic pairing – self-learning
- special functions: highly visible optical signalisation
- optical signaling on the doorbell
- optical signaling on the button
- maximum ringing volume: 110 dB
- option to add another button: yes, max. 8
- number of buttons in a package: 1 pc

- extra (spare) button: P5732T
- waterproof button: IP44
- power button: 1× 3 V CR2032 (included)
- number of receivers in a package: 1 pc
- volume control: yes, 4 levels
- power supply of the main unit: 230 V AC



**P5733W**  
34 02 122 000

1/-/-14  
P5733W



- reach of the button: 150 m
- number of melodies: 36
- pairing method: automatic pairing – self-learning
- special functions: highly visible optical signalisation
- optical signaling on the doorbell
- optical signaling on the button
- maximum ringing volume: 110 dB
- option to add another button: yes, max. 8
- number of buttons in a package: 1 pc

- extra (spare) button: P5732T
- waterproof button: IP44
- power button: 1× 3 V CR2032 (included)
- number of receivers in a package: 1 pc
- volume control: yes, 4 levels
- power supply of the main unit: 230 V AC



**P5733S**  
34 02 123 000

1/-/-14  
P5733S



- reach of the button: 150 m
- number of melodies: 36
- pairing method: automatic pairing – self-learning
- special functions: highly visible optical signalisation
- optical signaling on the doorbell
- optical signaling on the button
- maximum ringing volume: 110 dB
- option to add another button: yes, max. 8
- number of buttons in a package: 1 pc
- extra (spare) button: P5732T
- waterproof button: IP44
- power button: 1× 3 V CR2032 (included)
- number of receivers in a package: 1 pc
- volume control: yes, 4 levels
- power supply of the main unit: 230 V AC



**P5733G** 1/-/-/14  
34 02 124 000 P5733G



- reach of the button: 150 m
- number of melodies: 10
- pairing method: automatic pairing – self-learning
- optical signaling on the doorbell
- optical signaling on the button
- maximum ringing volume: 85 dB
- option to add another button: yes, max. 8
- number of buttons in a package: 1 pc
- extra (spare) button: P5734T
- waterproof button: IP56
- power button: 1× 3 V CR2032 (included)
- number of receivers in a package: 1 pc
- volume control: yes, 5 levels
- power supply of the main unit: 230 V AC



**P5734** 1/-/-/14  
34 02 125 000 P5734



- reach of the button: 150 m
- number of melodies: 10
- pairing method: automatic pairing – self-learning
- optical signaling on the doorbell
- optical signaling on the button
- maximum ringing volume: 85 dB
- option to add another button: yes, max. 8
- number of buttons in a package: 1 pc
- extra (spare) button: P5734T
- waterproof button: IP56
- power button: 1× 3 V CR2032 (included)
- number of receivers in a package: 1 pc
- volume control: yes, 5 levels
- power supply of the main unit: 230 V AC



**P5734B** 1/-/-/14  
34 02 126 000 P5734B



## Spare push buttons

- spare or additional buttons for EMOS doorbells
- wireless, compatible with certain door chime type
- most commonly require 1 battery, water resistant (IP44)

- power source: unpowered
- pairing method: self-learning (automatic pairing)
- range in open space: up to 150 m
- IP rating: IP55
- designed for the type of bell: P5750, P5750.2T, P575



**P5750T** 1/-/-/50  
34 02 118 001 P5750T



- power source: 1× 3 V CR2032 (included)
- pairing method: self-learning (automatic pairing)
- range in open space: up to 120 m
- IP rating: IP44
- designed for the type of bell: P5760, P5763, P5763R



**P5760T**  
34 02 060 002

1/-/5/40  
P5760T

- power source: 1× 3 V CR2032 (included)
- pairing method: self-learning (automatic pairing)
- range in open space: up to 100 m
- IP rating: IP44
- designed for the type of bell: 98103, 98098, 98105,



**P5723T**  
34 02 108 000

1/-/-/48  
98YK

- power source: 1× 3 V CR2032 (included)
- pairing method: self-learning (automatic pairing)
- range in open space: up to 150 m
- IP rating: IP44
- designed for the type of bell: P5727



**P5727T**  
34 02 112 000

1/-/-/50  
P5727T

- power source: 1× 12 V A23 (included)
- pairing method: self-learning (automatic pairing)
- range in open space: up to 180 m
- IP rating: IP56
- designed for the type of bell: P5728, P5730



**P5728T**  
34 02 113 000

1/-/-/50  
P5728T

- power source: unpowered
- pairing method: self-learning (automatic pairing)
- range in open space: up to 180 m
- IP rating: IP44
- designed for the type of bell: P5729, P5729B, P5731



**P5729T**  
34 02 114 000

1/-/-/50  
P5729T

- power source: 1× 3 V CR2032 (included)
- pairing method: self-learning (automatic pairing)
- range in open space: up to 100 m
- IP rating: IP44
- designed for the type of bell: P5732, P5733W, P573



**P5732T** 1/-/-/50  
34 02 117 001 P5732T

- power source: 1× 3 V CR2032 (included)
- pairing method: self-learning (automatic pairing)
- range in open space: up to 150 m
- IP rating: IP56
- designed for the type of bell: P5734, P5734B



**P5734T** 1/-/-/50  
34 02 126 001 P5734T

## Wired doorbells

- classic mechanical bells with one melody
- distance between bell and button exactly according to the user's needs
- constantly functional thanks to 230 V power supply

- reach of the button: wiring connection
- number of melodies: 1
- maximum ringing volume: 85 dB
- power button: wiring connection
- number of receivers in a package: 1 pc
- power supply of the main unit: 230 V AC



**P57001** 1/-/-/20  
34 01 000 010 P57001

- reach of the button: wiring connection
- number of melodies: 1
- maximum ringing volume: 85 dB
- power button: wiring connection
- number of receivers in a package: 1 pc
- power supply of the main unit: 230 V AC



**P57002** 1/-/-/20  
34 01 000 020 P57002



# Sensors GoSmart



- Sensors to secure your home
- Motion detection and instant notification in the app
- Window and door security check
- Real-time identification of unusual situations
- Connect to your home network via ZigBee protocol
- Compatibility with EMOS GoSmart products and TUYA devices
- Voice control with Google Assistant and Amazon Alexa

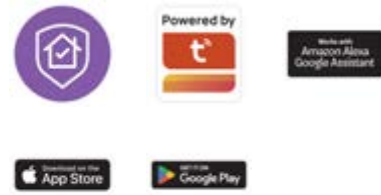

- product: motion sensor
- detection angle: 90°
- detection distance: 8 m
- IP rating: IP20
- sensor type: PIR
- power source: 1× CR123A (3 V)
- packaging: 1 pc, small box
- supported OS: Android, iOS
- compatibility: EMOS GoSmart, TUYA, LIDL, Smartlife
- protocol: Zigbee 3.0
- transmission frequency: 2.4 GHz (2 405–2 480 MHz)
- notifications to the mobile app
- application languages: EN, CZ, SK, PL, DE, HU, SI, FR,



8 592920 128749 | **H5020** | 1/-/-/40  
30 69 052 010 | IP-2210Z

- product: door/window sensor
- IP rating: IP20
- sensor type: magnetic
- power source: 1× CR2032 (3 V)
- packaging: 1 pc, small box
- supported OS: Android, iOS
- compatibility: EMOS GoSmart, TUYA, LIDL, Smartlife
- protocol: Zigbee 3.0
- transmission frequency: 2.4 GHz (2 405–2 480 MHz)
- notifications to the mobile app
- application languages: EN, CZ, SK, PL, DE, HU, SI, FR,



8 592920 128732 | **H5021** | 1/-/-/100  
30 69 052 020 | IP-2211Z

# Multimeters, testers



## Multimeters, measuring cables

- multimeters measure electrical quantities – voltage, etc.
- automatic or manual measurement range selection
- also measure temperature and allow diode or transistor tests
- clamp multimeter for higher values, w/o circuit interruption
- plus spare measuring leads with tips, for any multimeter

AC voltage: 600 mV – 750 V = AC current: 600  $\mu$ A–10 A = DC voltage: 600 mV – 1 000 V = DC current: 600  $\mu$ A–10 A = screen display: 5 3/4 digit = backlight display = range selection: both automatic and manual = electrical resistance: 600 Ohm – 60 MOhm = circuit continuity = diode test = transistor test = temperature measurement: -40 °C to +300 °C = max. value hold = Data hold mode = auto power off = included: battery, measurement tips, reduction for measuring transistors, temperature probe type K = power source: 1  $\times$  9 V (included) = dimensions: 35  $\times$  90  $\times$  190 mm



**M0430**

1/-/-/8

22 02 019 000

MD-430



AC voltage: 2–300 V = AC current: 200  $\mu$ A – 10 A / with pliers up to 1 000 A (not included) = DC voltage: 200 mV – 300 V = DC current: 200  $\mu$ A – 10 A / with pliers up to 1 000 A (not included) = screen display: 3.5 digit = backlight display = range selection: automatic = electrical resistance: 200 Ohm – 20 MOhm = circuit continuity = diode test = transistor test = temperature measurement: -20 °C to +1 000 °C = max. value hold = Data hold mode = auto power off = included: battery, test leads, reduction for measuring transistors, temp. probe type K, lock the battery cover = power source: 3  $\times$  1.5 V AAA (included) = dimensions: 35  $\times$  75  $\times$  158 mm



**M0420**

1/-/10/20

22 02 008 000

MD-420



AC voltage: 200 mV – 300 V = AC current: 20 mA – 10 A = DC voltage: 200 mV – 300 V = DC current: 20 mA – 10 A = screen display: 3.5 digit = backlight display = range selection: manual = non-contact AC voltage detection = electrical resistance: 200 Ohm – 20 MOhm = circuit continuity = diode test = battery test = temperature measurement: 0 °C to +1 000 °C = Data hold mode = included: battery, manual, measurement tips = power source: 1  $\times$  9 V (included) = dimensions: 168  $\times$  83  $\times$  35 mm



**M3691**

1/-/-/20

22 02 016 000

EM3691



AC voltage: 200–300 V = DC voltage: 200 mV – 300 V = DC current: 20 mA – 10 A = screen display: 3.5 digit = backlight display = range selection: manual = electrical resistance: 200 Ohm – 2 MOhm = circuit continuity = diode test = battery test = Data hold mode = included: battery, manual, measurement tips = power source: 1× 9 V (included) = dimensions: 150 × 75 × 35 mm



**M3620** 1/-/-/20  
22 02 017 000 MD-310

AC voltage: 200–600 V = AC current: 200 mA – 10 A = DC voltage: 2–600 V = DC current: 200 mA – 10 A = screen display: 3.5 digit = backlight display = range selection: manual = electrical resistance: 200 Ohm – 2 MOhm = circuit continuity = diode test = battery test: 1.5 V/9 V = temperature measurement: -40 °C to +300 °C = Data hold mode = auto power off = included: battery, manual, measurement tips, temperature probe = power source: 3× 1.5 V AAA (included) = dimensions: 35 × 75 × 155 mm



**M0230** 1/-/-/20  
22 02 020 000 MD-230

AC voltage: 2–600 V = AC current: 2 mA – 10 A = DC voltage: 200 mV – 600 V = DC current: 2 mA – 10 A = screen display: 3.5 digit = range selection: manual = electrical resistance: 200 Ohm – 20 MOhm = circuit continuity = diode test = transistor test = included: battery, manual, measurement tips = power source: 1× 9 V (included) = dimensions: 32 × 85 × 165 mm



**M2092** 1/-/5/15  
22 02 003 000 MD-220

AC voltage: 200–300 V = DC voltage: 200 mV – 300 V = DC current: 20 µA – 10 A = screen display: 3.5 digit = range selection: manual = electrical resistance: 200 Ohm – 2 MOhm = circuit continuity = diode test = included: battery, manual, measurement tips, protective case = power source: 1× 9 V (included) = dimensions: 27 × 70 × 135 mm



**M0391** 1/-/10/20  
22 02 007 000 MD-210

AC voltage: 200–300 V = DC voltage: 200 mV – 300 V = DC current: 2 000 µA – 200 mA = screen display: 3.5 digit = range selection: manual = electrical resistance: 200 Ohm – 2 MOhm = diode test = battery test: 1.5 V/9 V = included: battery, manual, measurement tips = power source: 1× 12 V (included) = dimensions: 30 × 57 × 95 mm



**M0320** 1/-/6/18  
22 02 014 000 MD-110

AC voltage: 4-600 V = AC current: 400 A = DC voltage: 400 mV - 600 V = DC current: 400 A = clamp multimeter = screen display: 3 3/4 digit = range selection: automatic = electrical resistance: 400 Ohm - 40 MOhm = circuit continuity = diode test = temperature measurement: -20 °C to +1 000 °C = Data hold mode = auto power off = included: battery, manual, measurement tips = power source: 2x 1.5 V AAA (included) = dimensions: 38 x 71 x 194 mm



**M0400**  
22 02 013 000

1/-/-20  
MD-410C

AC voltage: 2-600 V = AC current: 2-600 A = DC voltage: 200 mV - 600 V = clamp multimeter = screen display: 3.5 digit = range selection: automatic = electrical resistance: 200 Ohm - 20 MOhm = circuit continuity = diode test = Data hold mode = auto power off = included: battery, manual, measurement tips = power source: 2x 3 V CR2032 (included) = dimensions: 36 x 76 x 190 mm



**M0305**  
22 02 015 000

1/-/12/24  
MD-310C

cable length: 95 cm = maximum load: 1 A, 30 V AC, 60 V DC = possibility to tips exchange = colour: red, black = packaging: 1 pc, blister



**S4001N**  
23 04 000 101

1/5/-/50  
S4001N

cable length: 95 cm = maximum load: 10 A, 1 kV, CAT III = colour: red, black = packaging: packet

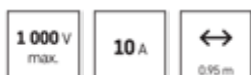

**S4003**  
23 04 000 300

1/-/-/200  
BB58

AC voltage: 2-600 V = AC current: 200 µA - 200 mA = DC voltage: 200 mV - 600 V = DC current: 200 µA - 200 mA = screen display: 3 1/2 digit = backlight display = range selection: automatic = electrical resistance: 200 Ohm - 20 MOhm = circuit continuity = diode test = max. value hold = Data hold mode = auto power off = included: battery, manual, measurement tips = power source: 2x 1.5 V AAA (included) = dimensions: 44 x 38 x 230 mm



**M3216**  
22 02 021 000

1/-/-/6  
MD-300

## Testers

- voltage tester for measuring voltage value
- also identifies phases, sequence and polarity
- detects DC and AC voltage, contact or non-contact
- results indicated optically and acoustically

DC voltage: 6–690 V = AC voltage: 6–690 V = AC/DC voltage: 6 V, 12 V, 24 V, 50 V, 120 V, 230 V, 400 V, 690 V = polarity indication = phase indication = signalization: optical + acoustic = power source: 2× 1.5 V AAA (included) = frequency range: 45–65 Hz = measuring of connections of circuits = packaging: 1 pc, blister

**M0071**

1/-/-/10

22 01 013 000

VT-710

DC voltage: 12–690 V = AC voltage: 12–690 V = AC/DC voltage: 12 V, 24 V, 50 V, 120 V, 230 V, 400 V, 690 V = polarity indication = phase indication = signalization: optical + acoustic = power source: 9 V (included) = frequency range: 0–60 Hz = measuring of connections of circuits = packaging: 1 pc, blister

**M0012A**

1/5/-/15

22 01 014 000

VT-320

DC voltage: 110–400 V = AC voltage: 110–400 V = AC/DC voltage: 110 V, 230 V, 400 V = polarity indication = phase indication = signalization: optical = power source: from power source = frequency range: 0–60 Hz = packaging: 1 pc, blister

**M0014A**

1/5/-/15

22 01 012 000

VT-310

detection: AC wiring = signalization: optical + acoustic = AC voltage: 70–1 000 V = dimensions: 153 × 22 mm = power source: 2× 1.5 V AAA (included) = packaging: 1 pc, blister

**M0007A**

1/-/30/60

22 05 000 010

VT-150



DC voltage: 0 to 250 V contactless = AC voltage: 70 to 250 V contactless = AC/DC voltage: 0-250 V, 70-250 V = polarity indication = non-contact measuring: polarity of sources and short-circuit, microwave ovens monitors emission = signalization: optical = power source: 2x 1.5 V LR41 (included) = frequency range: 0-60 Hz = packaging: 1 pc, blister



**M0018**  
22 01 001 000

1/5/-/45  
VT-110

DC voltage: 0 to 250 V contactless = AC voltage: 70 to 250 V contactless = AC/DC voltage: 0-250 V, 70-250 V = polarity indication = non-contact measuring: polarity of sources and short-circuit, microwave ovens monitors emission = two settings of sensitivity = signalization: optical + acoustic = power source: 2x 1.5 V LR44 (included) = frequency range: 0-60 Hz = packaging: 1 pc, blister



**M0048**  
22 01 002 000

1/5/-/50  
VT-120

DC voltage: 6-400 V = AC voltage: 6-400 V = AC/DC voltage: 6 V, 12 V, 24 V, 50 V, 120 V, 230 V, 400 V = polarity indication = signalization: optical = power source: from power source = frequency range: 0-60 Hz = packaging: 1 pc, blister



**M0003B**  
22 01 015 000

1/-/5/40  
VT-211

designed for battery type: AAA, AA, C, D, 9 V and for button cells 1.5 V, 3 V = type: UNI D3 = value of load resistance for the AA, AAA, C, D, 9 V: universal = the value of load resistance for button batteries: universal = dimensions: 110 x 60 x 25 mm



**N0322**  
22 03 003 000

1/-/5/50  
UNI D3

## Measuring instruments

- multidetector maps electrical wiring – no more drilled wires
- laser range finder calculates distance, area and room volume
- non-contact voltage detector for AC voltage up to 1 000 V

detection: wood, metal, AC wiring = signalization: optical + acustic = dimensions: 28 × 72 × 155 mm = power source: 1 × 9 V (included) = packaging: 1 pc, blister

**M0501**

1/-/5/30

22 06 000 010

M0501

measuring distance: 0.05–40 m = measuring functions: length, surface, volume, continual measurement, Pythagoras = measuring units: m, ft, in, m<sup>2</sup>, ft<sup>2</sup>, m<sup>3</sup>, ft<sup>3</sup> = power source: 2 × 1.5 V AAA (not included) = packaging: 1 pc, small box

**M0502**

1/-/-/50

22 06 000 020

M0502

measuring functions: temperature = measuring units: °C/°F = power source: 1 × 9 V = packaging: 1 pc, blister

**M0503**

1/-/-/18

22 06 000 030

M0503

# Thermostats, CO and smoke alarms



## Thermostats

### Thermostats EMOS

- indoor thermostats regulate heating systems & cooling units
- manual and digital, with programmable heating cycle
- wireless, wired and clamp-on (monitor service water temp.)
- often with backlit display and always with freeze protection
- bestseller: wireless digital thermostats (simple to install)

thermostat type: wireless with OpenTherm communication = type of control: programmable electronic indoor thermostat = backlight display = control mode: heating and cooling system = number of programs: 6 + 3 customizable for users = temperature adjustment type: comfort and economy temperature = temperature measurement: 0 °C to 40 °C, resolution 0.2 °C = temperature adjustment: from 7 °C up to 30 °C, after 0.2 °C = anti-frost protection = ON/OFF function = switching: 230 V AC or potential-free = switching load: 16 A resistive, 5 A inductive = power of transmitter: 2 × 1.5 V AA (included) = power of receiver: 230 V AC = receiver's dimension: 37 × 115 × 91 mm = transmitter's dimension: 23 × 97 × 122 mm



**P56110T**

1/-/-/10

21 01 309 000

P56110T



thermostat type: wireless = type of control: programmable electronic room thermostat, option to control via mobile phone (iOS, Android) = backlight display = control mode: heating system = number of programs: customisable = temperature adjustment type: 6 temperature changes per day = temperature measurement: 0 °C to 40 °C, resolution 0.1 °C = temperature adjustment: 5 °C to 35 °C, resolution 0.5 °C = anti-frost protection = ON/OFF function = holiday mode = switching: 230 V AC or potential-free = switching load: 16 A resistive, 4 A inductive = power of transmitter: 5 V USB adapter (included) = power of receiver: 230 V AC = receiver's dimension: 37 × 86 × 86 mm = transmitter's dimension: 15 × 96 × 96 mm = part of the package: wireless thermostat, wireless receiver, USB car charger 5 V/1.5 A, micro USB cable 1.5 m



**P5623**

1/-/-/8

21 01 306 000

P5623





www.emos.eu

Order Code  
Item Number

Packaging  
Type

thermostat type: wireless with OpenTherm communication = type of control: programmable electronic indoor thermostat = backlight display = control mode: heating and cooling system = number of programs: 1 customisable programme or customisable temperature (6× per day) = temperature adjustment type: 6 temperature changes per day = temperature measurement: 0 °C to 40 °C, resolution 0.1 °C = temperature adjustment: from 5 °C up to 35 °C, after 0.5 °C = anti-frost protection = ON/OFF function = holiday mode = switching: 230 V AC or potential-free = switching load: 10 A resistive, 4 A inductive = power of transmitter: 2× 1.5 V AA (included) = power of receiver: 230 V AC = receiver's dimension: 26 × 86 × 86 mm = transmitter's dimension: 26 × 126 × 84 mm



**P56160T** 1/-/-12  
21 01 307 000 P56160T

thermostat type: wireless = type of control: manual electronic indoor thermostat = backlight display = control mode: heating and cooling system = number of programs: user adjustable temperature = temperature adjustment type: manually = temperature measurement: 0 °C to 40 °C, resolution 0.1 °C = temperature adjustment: from 5 °C up to 35 °C, after 0.5 °C = anti-frost protection = ON/OFF function = switching: 230 V AC or potential-free = switching load: 16 A resistive, 4 A inductive = power of transmitter: 2× 1.5 V AAA (included) = power of receiver: 230 V AC = receiver's dimension: 26 × 86 × 86 mm = transmitter's dimension: 28 × 120 × 77 mm



**P5614** 1/-/-12  
21 01 106 010 P5614

thermostat type: wired with OpenTherm communication = type of control: programmable electronic indoor thermostat = backlight display = control mode: heating and cooling system = number of programs: 1 customisable programme or customisable temperature (6× per day) = temperature adjustment type: 6 temperature changes per day = temperature measurement: 0 °C to 40 °C, resolution 0.1 °C = temperature adjustment: from 5 °C up to 35 °C, after 0.5 °C = anti-frost protection = ON/OFF function = holiday mode = switching: 230 V AC or potential-free = switching load: 6 A resistive, 2 A inductive = power source: 2× 1.5 V AA (included) = dimensions: 26 × 126 × 84 mm



**P56060T** 1/-/-40  
21 01 208 000 P56060T

thermostat type: wire = type of control: programmable electronic indoor thermostat = backlight display = control mode: heating and cooling system = number of programs: 1 customisable programme or customisable temperature (6× per day) = temperature adjustment type: 6 temperature changes per day = temperature measurement: 0 °C to 40 °C, resolution 0.1 °C = temperature adjustment: from 5 °C up to 35 °C, after 0.5 °C = anti-frost protection = switching: 230 V AC or potential-free = switching load: 8 A resistively, 2 A inductively = power source: 2× 1.5 V AAA (included) = dimensions: 26 × 120 × 78 mm



**P5607** 1/-/-20  
21 01 209 000 P5607

thermostat type: wire = type of control: manual indoor thermostat = backlight display = control mode: heating and cooling system = number of programs: user adjustable temperature = temperature adjustment type: manually = temperature measurement: 0 °C to 40 °C, resolution 0.1 °C = temperature adjustment: from 5 °C up to 35 °C, after 0.5 °C = anti-frost protection = switching: 230 V AC or potential-free = switching load: 8 A resistively, 2 A inductively = power source: 2× 1.5 V AAA (included) = dimensions: 30 × 120 × 77 mm



**P5604** 1/-/-40  
21 01 106 000 P5604

thermostat type: wire = type of control: manual indoor thermostat = control mode: heating and cooling system = number of programs: user adjustable temperature = temperature adjustment type: manually = temperature measurement: 0 °C to 40 °C, resolution 1 °C = temperature adjustment: from 5 °C up to 30 °C, after 1 °C = anti-frost protection = switching: 230 V AC or potential-free = switching load: 6 A resistive, 2 A inductive = power source: 2× 1.5 V AA (included) = dimensions: 40 × 93 × 86 mm



**P5603R**  
21 01 106 001

1/-/-/36  
P5603R



thermostat type: wired for underfloor heating, concealed = type of control: programmable electronic indoor thermostat = backlight display = control mode: heating system = number of programs: 1 customisable programme or customisable temperature (6× per day) = temperature adjustment type: 6 temperature changes per day = temperature measurement: 0 °C to 99 °C, resolution 0.1 °C = temperature adjustment: from 5 °C up to 95 °C, after 0.5 °C = anti-frost protection = ON/OFF function = switching: voltage 230 V AC, 50 Hz = switching load: 16 A resistive = power source: 230 V AC = dimensions: 43 × 86 × 90 mm = part of the package: thermostat, floor sensor 3 m



**P5601UF**  
21 01 210 000

1/-/-/14  
P5601UF



thermostat type: wire, flow thermostat = type of control: manual thermostat = control mode: heating and cooling system = temperature measurement: 0 °C to 90 °C = temperature adjustment: 0 °C to 90 °C, resolution 5 °C = switching: voltage 230 V AC, 50 Hz = switching load: 16 A resistive, 4 A inductive = power source: 230 V, 400 V AC = dimensions: 38 × 54 × 105 mm



**P5681**  
21 01 103 000

1/-/5/20  
T80

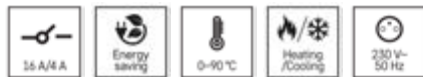

thermostat type: wire, capillary sensor thermostat = type of control: manual thermostat = control mode: heating and cooling system = temperature measurement: 0 °C to 90 °C = temperature adjustment: 0 °C to 90 °C, resolution 5 °C = switching: voltage 230 V AC, 50 Hz = switching load: 16 A resistive, 4 A inductive = capillary sensor length: 1 m, Ø 7 mm = power source: 230 V, 400 V AC = dimensions: 38 × 54 × 105 mm



**P5682**  
21 01 104 000

1/-/5/20  
T80F



thermostat type: wire, flow thermostat = type of control: manual thermostat = backlight display = control mode: heating and cooling system = temperature adjustment type: manually = temperature measurement: 5 °C to 80 °C, resolution 0.1 °C = temperature adjustment: from 5 °C up to 80 °C, after 0.1 °C = ON/OFF function = switching: voltage 230 V AC, 50 Hz = switching load: 5 A resistively, 1.5 A inductively = power source: 230 V AC = dimensions: 41 × 50 × 138 mm



**P5683**  
21 01 107 000

1/-/5/30  
P5683







www.emos.eu

Order Code  
Item Number

Packaging  
Type

thermostat type: wire, capillary sensor thermostat = type of control: manual thermostat = backlight display = control mode: heating and cooling system = temperature adjustment type: manually = temperature measurement: 5 °C to 90 °C, resolution 0.1 °C = temperature adjustment: from 5 °C up to 90 °C, after 0.1 °C = ON/OFF function = switching: voltage 230 V AC, 50 Hz = switching load: 5 A resistively, 1.5 A inductively = capillary sensor length: 0.9 m, Ø 6 mm = power source: 230 V AC = dimensions: 36 × 45 × 138 mm



**P5684**  
21 01 108 000

1/-/5/30  
P5684

thermostat type: wire, flow thermostat = type of control: manual thermostat = control mode: heating and cooling system = temperature measurement: 0 °C to 90 °C = temperature adjustment: 0 °C to 90 °C, resolution 5 °C = switching: voltage 230 V AC, 50 Hz = switching load: 16 A resistive, 4 A inductive = power source: 230 V, 400 V AC = dimensions: 57 × 38 × 108 mm, thermowell: 110 mm, Ø 8 mm, 1/2" thread



**P5685**  
21 01 109 000

1/-/5/15  
P5685

thermostat type: wire, flow thermostat = type of control: manual thermostat = backlight display = control mode: heating and cooling system = temperature adjustment type: manually = temperature measurement: 5 °C to 80 °C, resolution 0.1 °C = temperature adjustment: from 5 °C up to 80 °C, after 0.1 °C = ON/OFF function = switching: voltage 230 V AC, 50 Hz = switching load: 5 A resistively, 1.5 A inductively = power source: 230 V AC = dimensions: 45 × 36 × 140 mm, thermowell: 58 mm, Ø 8 mm, 1/2" thread



**P5686**  
21 01 110 000

1/-/5/20  
P5686

thermostat type: wireless with OpenTherm communication = switching: 230 V AC or potential-free = switching load: 16 A resistive, 5 A inductive = power of receiver: 230 V AC = receiver's dimension: 37 × 115 × 91 mm



**P56110TR**  
21 01 308 000

1/-/-/36  
P56110TR

thermostat type: socket = type of control: programmable electronic indoor thermostat = backlight display = control mode: heating and cooling system = number of programs for thermostat: customisable temperature (6 × per day) = temperature adjustment type: 6 temperature changes per day = temperature measurement: 0 °C to 45 °C, resolution 0.1 °C = temperature adjustment: 5 °C to 40 °C, resolution 0.5 °C = adjustable variance of temperature: from 0.2 °C up to 2 °C, after 0.1 °C = number of programs for timer: 24 = number of switching per day for timer: 24 = function to change summer/winter time = countdown function = dimensions: 82 × 62 × 146 mm



**P5660FR**  
21 06 000 100

1/-/-/16  
P5660FR

# Thermostats GoSmart



- Reduce heating/cooling costs for buildings
- Individual temperature settings for different rooms
- Set temperature scenarios for specific day and time
- Control all settings from anywhere using the app
- Heating or air conditioning control based on GPS location
- Connection via WIFI or Zigbee protocols
- Compatibility with EMOS GoSmart products and TUYA devices
- Voice control with Google Assistant and Amazon Alexa

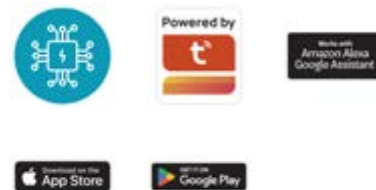

thermostat type: wire = type of control: programmable electronic room thermostat, option to control via mobile phone (iOS, Android) = backlight display = control mode: heating and cooling system = number of programs: customisable temperature (6× per day) = temperature adjustment type: 6 temperature changes per day = temperature measurement: 0 °C to 40 °C, resolution 0.1 °C = temperature adjustment: from 5 °C up to 35 °C, after 0.5 °C = anti-frost protection = ON/OFF function = holiday mode = switching: voltage 230 V AC, 50 Hz = switching load: 6 A resistive, 2 A inductive = power source: 230 V AC = dimensions: 138 × 88 × 33 mm



**P56201** 1/-/-12  
21 01 900 000 P56201

thermostat type: wireless = type of control: programmable electronic room thermostat, option to control via mobile phone (iOS, Android) = backlight display = control mode: heating and cooling system = number of programs: customisable temperature (6× per day) = temperature adjustment type: 6 temperature changes per day = temperature measurement: 0 °C to 40 °C, resolution 0.1 °C = temperature adjustment: from 5 °C up to 35 °C, after 0.5 °C = anti-frost protection = ON/OFF function = holiday mode = switching: 230 V AC or potential-free = switching load: 16 A resistive, 4 A inductive = power of transmitter: 5 V USB adapter (included) = power of receiver: 230 V AC = receiver's dimension: 37 × 86 × 86 mm = transmitter's dimension: 40 × 138 × 96 mm



**P56211** 1/-/-9  
21 01 900 001 P56211

thermostat type: wired for underfloor heating, concealed = type of control: programmable electronic room thermostat, option to control via mobile phone (iOS, Android) = backlight display = control mode: heating system = number of programs: customisable temperature (6× per day) = temperature adjustment type: 6 temperature changes per day = temperature measurement: 0 °C to 95 °C, resolution 0.5 °C = temperature adjustment: from 1 °C up to 70 °C, after 0.5 °C = anti-frost protection = ON/OFF function = holiday mode = switching: voltage 230 V AC, 50 Hz = switching load: 16 A resistive = power source: 230 V AC = dimensions: 86 × 86 × 43 mm = part of the package: thermostat, floor sensor 3 m, Ø 8 mm



**P56201UF** 1/-/-36  
21 01 900 002 P56201UF

thermo shut-off valve: SMART, programmable = number of programs: 1 customisable programme or customisable temperature (6× per day) = temperature adjustment type: 6 temperature changes per day = temperature measurement: 0 °C to 70 °C, resolution 0.5 °C = temperature adjustment: 1 °C to 70 °C, resolution 0.5 °C = anti-frost protection = holiday mode = open window function = child lock = matrix: M30 × 1.5 mm = enclosed adaptors: Danfoss RA, RAV, RAVL = power source: 2× 1.5 V AA (included) = dimensions: 55 × 94 × 55 mm = packaging: 1 pc, small box



**P5630S** 1/-/-24  
21 01 900 003 P5630S

# CO and smoke alarms

- life investment for families w/ gas boiler/cooker/fireplace
- CO detector identifies carbon monoxide (invisible, odorless)
- smoke detector alerts to potential fires in the household
- EMOS detectors with 7 or 10 year service life

detection type: detector CO = type of installation: possible to mount on the wall or freestanding = type of signaling: optical and audible = operating temperature: -10 °C to 40 °C = operating humidity: 30-95 % = lifetime: 10 years = IP rating: IP30 = power source: 2x 1.5 V AA, included = packaging: 1 pc, small box



 **P56402** 1/-/5/15  
21 01 501 020 GS827

detection type: smoke detector = type of installation: possible to mount on the wall or freestanding = type of signaling: optical and audible = possibility to connect to other detectors: yes, wireless = module range: up to 20 m = transmission frequency: 433 MHz = operating temperature: 10 °C to 45 °C = operating humidity: 30-95 % = lifetime: 10 years = IP rating: IP20 = power source: 2x 1.5 V AA, included = packaging: 1 pc, small box



 **P56500** 1/-/5/15  
21 01 505 000 GS558

detection type: smoke detector = type of installation: possible to mount on the wall or freestanding = type of signaling: optical and audible = operating temperature: 0 °C to 40 °C = operating humidity: 5-95 % = lifetime: 10 years = power source: 1x 9 V, included = packaging: 1 pc, small box



 **P56501** 1/-/5/40  
21 04 101 000 GS536

detection type: gas detector = type of installation: possible to mount on the wall or freestanding = type of signaling: optical and audible = operating temperature: -10 °C to 40 °C = operating humidity: 0-95 % = lifetime: 5 years = IP rating: IPX20 = power source: 230 V AC = packaging: 1 pc, small box



 **P56450** 1/-/1/18  
21 01 505 003 GS869

detection type: smoke detector = type of installation: wall mounting = type of signaling: optical and audible = possibility to connect to other detectors: yes, by wire (max. 40 pcs) = operating temperature: 0 °C to 40 °C = operating humidity: 0-93 % = lifetime: 10 years = power source: 230 V AC, back-up battery: 1× 9 V, included = packaging: 1 pc, small box



**P56502** 1/-/-/12  
21 01 505 006 TSS890B-HI

detection type: heat detector = type of installation: possible to mount on the wall or freestanding = type of signaling: optical and audible = operating temperature: 0 °C to 65 °C = operating humidity: 0-93 % = lifetime: 10 years = power source: 1× 9 V, included = packaging: 1 pc, small box



**P56300** 1/-/-/30  
21 04 102 000 THS916A

## Valve closer GoSmart



- Manual and automatic control
- Timer function for setting a schedule
- High power and torque
- Immediate response to crash detection
- Connection to home network via ZIGBEE protocol
- Compatibility with EMOS GoSmart products and TUYA devices
- Voice control with Google Assistant and Amazon Alexa

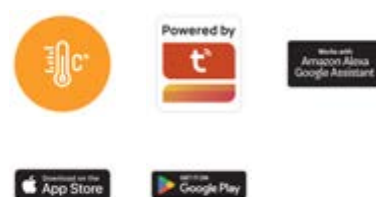

- product: valve controller
- pipe diameter: 1/2", 3/4", 1" a 1 1/4"
- torque: max. 5.88 Nm
- operating temperature: -10 °C to 55 °C
- operating humidity: <95 %
- IP rating: IP20
- power source: DC 12 V/1 000 mA, 1.4 m (included)
- supported OS: Android, iOS
- compatibility: EMOS GoSmart, TUYA, LIDL, Smartlife
- protocol: Zigbee 3.0
- transmission frequency: 2.4 GHz Wi-Fi
- notifications to the mobile app
- control by voice assistants
- application languages: EN, CZ, SK, PL, DE, HU, SI, FR,



**P5640S** 1/-/-/12  
21 05 564 000 P5640S



# Detectors GoSmart



- Detectors to secure your home
- Immediate notification of an unusual situation via the app
- Optical and audible signalling
- Sensors that detect water/gas leaks, fire, etc.
- Connect to your home network via Wi-Fi/ZigBee protocol
- Compatibility with EMOS GoSmart products and TUYA devices
- Voice control with Google Assistant and Amazon Alexa



- detection type: smoke detector
- type of installation: possible to mount on the wall o
- type of signaling: optical and audible
- transmission frequency: 2.4 GHz Wi-Fi
- operating temperature: 0 °C to 40 °C
- operating humidity: 0-93 %
- lifetime: 10 years
- IP rating: IP20
- power source: 2× 1.5 V AA, included
- packaging: 1 pc, small box
- supported OS: Android, iOS
- compatibility: EMOS GoSmart, TUYA, LIDL, Smartlife,
- protocol: Wi-Fi
- notifications to the mobile app
- application languages: EN, CZ, SK, PL, DE, HU, SI, FR,



**P56500S** 1/-/-16  
21 04 103 000 TSS380C-HW

- detection type: water leak detector
- type of installation: free-standing
- type of signaling: optical and audible
- memory of alarms
- transmission frequency: Zigbee 3.0
- operating temperature: 5 °C to 38 °C
- operating humidity: ≤80 % without condensation
- lifetime: 10 years
- IP rating: IP65
- power source: 1× 3 V CR2, included
- packaging: 1 pc, small box
- supported OS: Android, iOS
- compatibility: EMOS GoSmart, TUYA, LIDL, Smartlife,
- protocol: Zigbee 3.0
- notifications to the mobile app
- application languages: EN, CZ, SK, PL, DE, HU, SI, FR,



**P56000S** 1/-/-48  
21 04 104 000 P56000S

- detection type: detector CO
- type of installation: possible to mount on the wall o
- type of signaling: optical and audible
- memory of alarms
- transmission frequency: 2.4 GHz Wi-Fi
- operating temperature: -10 °C to 40 °C
- operating humidity: 15-93 %
- lifetime: 10 years
- IP rating: IP30
- power source: 2× 1.5 V AA, included
- packaging: 1 pc, small box
- supported OS: Android, iOS
- compatibility: EMOS GoSmart, TUYA, LIDL, Smartlife,
- protocol: Wi-Fi
- notifications to the mobile app
- application languages: EN, CZ, SK, PL, DE, HU, SI, FR,



**P56400S** 1/-/-20  
21 04 105 000 TCS0101W



# Installation material, tapes



## Installation material



### Sockets, switches

## EMOS

### IP20



- installation: into a junction box
- in white colour
- frame and button material: high-quality polycarbonate (PC)

**A6100.0**      1/-/10/60  
19 06 200 100      W13-C120Y



product: alternating switch no. 6 = design: IP20 = type: 250 V~ = type of mounting: into a box = version: 1 button stairway = IP rating: IP20 = colour: white (gloss) = packaging: 1 pc, hanging

**A6100.2**      1/-/10/60  
19 06 200 102      W13-C210/1Y



product: cross switch no. 7 = type: 250 V~/10 AX = type of mounting: into a box = version: 1 button = IP rating: IP20 = colour: white (gloss) = packaging: 1 pc, hanging

**A6100.4**      1/-/10/60  
19 06 200 104      W13-C130Y

product: switch controller (1/0) = type: 250 V~/10 A = type of mounting: into a box = version: 1 button = IP rating: IP20 = colour: white (gloss) = packaging: 1 pc, hanging

**A6100.1**      1/-/10/60  
19 06 200 101      W13-C210Y

product: parallel switch nr. 5 = type: 250 V~/10 AX = type of mounting: into a box = version: 2 buttons = IP rating: IP20 = colour: white (gloss) = packaging: 1 pc, hanging



www.emos.eu

Order Code  
Item Number

Packaging  
Type

**A6100.3** 1/-/10/60  
19 06 200 103 W13-C230Y

product: double two-way switch 6+6 (5B) = type: 250 V~/10 AX = type of mounting: into a box = version: 2 buttons = IP rating: IP20 = colour: white (gloss) = packaging: 1 pc, hanging

**A6003.0** 1/-/10/40  
19 06 300 103 W13-C19Z

product: switching device for adjustable LED lamps for turn-controls and button switching = design: 7-110 W/VA vakuové a halogenové žárovky na 230 V~, stmívatelné kompaktní zářivky. 3-60 W/VA pro stmívatelné LED = type: 230 V~, 50 Hz = version: turn-controls and button switching = colour: white (gloss) = packaging: 1 pc, hanging

**A6000.5** 1/-/10/40  
19 06 010 512 W13-C311FUSBAC

product: single socket with protective contacts and USB output 3 A max. = design: SCHUKO = type: 250 V~/16 A max. = type of mounting: into a box (recommended depth min. 60 mm) = version: single = IP rating: IP20 = colour: white (gloss) = packaging: 1 pc, PE packet

**A6000.1** 1/-/10/40  
19 06 010 501 W13-311FUSB2A

product: single socket with protective side contacts and USB output 2.1 A max. = design: SCHUKO = type: 250 V~/16 A max. = type of mounting: into a box (recommended depth min. 40 mm) = version: single = IP rating: IP20 = colour: white (gloss) = packaging: 1 pc, PE packet

**A6004.2** 1/-/5/30  
19 06 300 100 W13-C004

product: quadruple frame = type: for horizontal and vertical installation = type of mounting: into a box = version: quadruple = colour: white (gloss) = packaging: 1 pc, hanging

**A6004.0** 1/-/10/60  
19 06 300 102 W13-C002

product: double frame = type: for horizontal and vertical installation = type of mounting: into a box = version: double = colour: white (gloss) = packaging: 1 pc, hanging

**A6004.1** 1/-/10/60  
19 06 300 101 W13-C003

product: triple frame = type: for horizontal and vertical installation = type of mounting: into a box = version: triple = colour: white (gloss) = packaging: 1 pc, hanging

**A6004.4** 1/-/10/240  
19 06 300 105 W13-CTF/2

product: data socket cover 2xRJ45 = type of mounting: into a box = version: double = colour: white (gloss) = packaging: 1 pc, hanging

**A6004.3** 1/-/10/240  
19 06 300 104 W13-CTRSO

product: socket cover TV+R+SAT = type of mounting: into a box = version: single = colour: white (gloss) = packaging: 1 pc, hanging

**A6002.0** 1/-/10/60  
19 06 010 504 W13-C311

product: single socket with protective side contact = design: SCHUKO = type: 250 V~/16 A max. = type of mounting: into a box = version: single = IP rating: IP20 = colour: white (gloss) = packaging: 1 pc, hanging



www.emos.eu

Order Code  
Item Number

Packaging  
Type



**A6100.5** 1/-/10/60  
19 06 200 105 W13-C120Y







product: alternating switch no. 6 = type: 250 V~/10 AX = type of mounting: into a box = version: 1 button stairway = IP rating: IP20 = colour: anthracite = packaging: 1 pc, hanging

**A6100.7** 1/-/10/60  
19 06 200 107 W13-C210/1Y



product: cross switch no. 7 = type: 250 V~/10 AX = type of mounting: into a box = version: 1 button = IP rating: IP20 = colour: anthracite = packaging: 1 pc, hanging

**A6100.9** 1/-/10/60  
19 06 200 109 W13-C130Y

product: switch controller (1/0) = type: 250 V~/10 A = type of mounting: into a box = version: 1 button = IP rating: IP20 = colour: anthracite = packaging: 1 pc, hanging

**A6100.6** 1/-/10/60  
19 06 200 106 W13-C210Y

product: parallel switch nr. 5 = type: 250 V~/10 AX = type of mounting: into a box = version: 2 buttons = IP rating: IP20 = colour: anthracite = packaging: 1 pc, hanging

**A6100.8** 1/-/10/60  
19 06 200 108 W13-C230Y





product: double two-way switch 6+6 (5B) = type: 250 V~/10 AX = type of mounting: into a box = version: 2 buttons = IP rating: IP20 = colour: anthracite = packaging: 1 pc, hanging

**A6003.1** 1/-/10/40  
19 06 300 109 W13-C192





product: switching device for adjustable LED lamps for turn-controls and button switching = design: 7-110 W/VA vakuové a halogenové žárovky na 230 V~, stmívatelné kompaktní zářivky. 3-60 W/VA pro stmívatelné LED = type: 230 V~, 50 Hz = version: turn-controls and button switching = colour: anthracite = packaging: 1 pc, hanging

**A6000.3** 1/-/10/40  
19 06 010 507 W13-311FUSB2A





product: single socket with protective side contact and USB output 2.1 A max. = design: SCHUKO = type: 250 V~/16 A max. = type of mounting: into a box (recommended depth min. 40 mm) = version: single = IP rating: IP20 = colour: anthracite = packaging: 1 pc, PE packet



**A6002.2** 1/-/10/60  
19 06 010 510 W13-C311







product: single socket with protective pin and child safety cover = design: SCHUKO = type: 250 V~/16 A max. = type of mounting: into a box = version: single = IP rating: IP20 = colour: anthracite = packaging: 1 pc, hanging

**A6004.5** 1/-/10/60  
19 06 300 108 W13-C002

product: double frame = type: for horizontal and vertical installation = type of mounting: into a box = version: double = colour: anthracite = packaging: 1 pc, hanging

**A6004.6** 1/-/10/60  
19 06 300 107 W13-C003

product: triple frame = type: for horizontal and vertical installation = type of mounting: into a box = version: triple = colour: anthracite = packaging: 1 pc, hanging





www.emos.eu

Order Code  
Item Number



Packaging  
Type

**A6004.7** 1/-/5/30  
19 06 300 106 W13-C004



product: quadruple frame = type: for horizontal and vertical installation = type of mounting: into a box = version: quadruple = colour: anthracite = packaging: 1 pc, hanging

**A6004.8** 1/-/10/240  
19 06 300 110 W13-CTRSO

product: socket cover TV+R+SAT = type of mounting: into a box = version: single = colour: anthracite = packaging: 1 pc, hanging

**A6004.9** 1/-/10/240  
19 06 300 111 W13-CTF/2RJ45







product: data socket cover 2xRJ45 = type of mounting: into a box = version: double = colour: anthracite = packaging: 1 pc, hanging

## IP54/IP44



- installation: onto a wall
- enclosure: IP54, IP44
- double socket is internally interconnected

**A1398** 1/5/-/60  
31 04 139 800 EF600SA



product: alternating switch - no. 6 = type: 250 V~/10 AX = type of mounting: on the wall = version: 1 button stairway, waterproof = IP rating: IP54 = colour: grey-black = packaging: 1 pc, PE packet

**A1398.1** 1/5/-/60  
31 04 139 811 EF602S (EF602SA)



product: serial switch no. 5 (chandelier) = type: 250 V~/10 AX = type of mounting: on the wall = version: 2 buttons classic water-resistant = IP rating: IP54 = colour: grey-black = packaging: 1 pc, PE packet

**A1398.2** 1/5/-/60  
19 50 011 202 EF600SB

product: cross switch no. 7 = type: 250 V~/10 AX = type of mounting: on the wall = version: 1 button = IP rating: IP54 = colour: grey-black = packaging: 1 pc, PE packet

**A1399** 1/5/-/60  
19 50 011 201 EF600SD

product: switch controller (1/0) = type: 250 V~/10 A = type of mounting: on the wall = version: 1 button = IP rating: IP54 = colour: grey-black = packaging: 1 pc, PE packet





www.emos.eu

Order Code  
Item Number

Packaging  
Type



**A1396** 1/5/-/60  
31 04 139 600 EF600G



product: socket with earthing pin and lid = design: SCHUKO = type: 250 V~/16 A max. = type of mounting: on the wall = version: single water-resistant = IP rating: IP44 = colour: grey-black = packaging: 1 pc, PE packet

**A1398.3** 1/5/-/60  
19 50 011 203 EF600SA-B

product: alternating switch no. 6 = type: 250 V~/10 AX = type of mounting: on the wall = version: 1 button stairway, waterproof = IP rating: IP54 = colour: white = packaging: 1 pc, PE packet



**A1396.1** 1/5/-/25  
31 04 139 611 EF602G









product: double socket with earthing pins and lids with interconnection = design: SCHUKO = type: 250 V~/16 A max. = type of mounting: on the wall = version: double water-resistant = IP rating: IP44 = colour: grey-black = packaging: 1 pc, PE packet

**A1398.4** 1/5/-/60  
19 50 011 204 EF602S-B

product: serial switch no. 5 (chandelier) = type: 250 V~/10 AX = type of mounting: on the wall = version: 2 buttons classic water-resistant = IP rating: IP54 = colour: white = packaging: 1 pc, PE packet

**A1396.2** 1/5/-/25  
19 50 011 207 EF600SAG







product: combination of alternating switch nr.6 and socket with earthing pin and lid = design: SCHUKO = type: socket 250 V~/16 A max.; switch 250 V~, 10AX = type of mounting: on the wall = version: double water-resistant - 1x socket + 1x alternating switch = IP rating: IP44 = colour: grey-black = packaging: 1 pc, PE packet

## Scene switches GoSmart

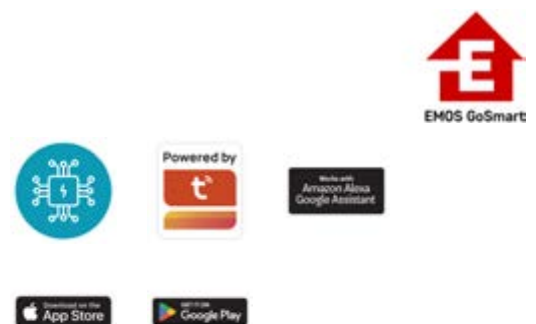
- Control multiple electrical devices or lights at once
- Define trigger events for individual buttons
- Long power supply battery life - up to 2 years
- Installation without pulling electrical cables
- Three-position buttons - press, double press, long press
- Communication via Zigbee protocol
- Compatible with EMOS GoSmart products and TUYA devices
- Voice control with Google Assistant and Amazon Alexa

- product: IP Smart Scene Switcher
- connectivity: ZigBee 2.4 GHz
- compatibility: EMOS GoSmart, TUYA, LIDL, Smartlife
- protocol: Zigbee 3.0
- pairing: automatic, manual
- use: automation
- number of control buttons: 1
- power supply: CR 2430 3 V
- supported OS: Android, iOS



**H5011** 1/-/-/60  
30 69 050 110 IP-2001ZW





www.emos.eu

Order Code  
Item Number

Packaging  
Type

- product: IP Smart Scene Switcher
- connectivity: ZigBee 2.4 GHz
- compatibility: EMOS GoSmart, TUYA, LIDL, Smartlife
- protocol: Zigbee 3.0
- pairing: automatic, manual
- use: automation
- number of control buttons: 2
- power supply: CR 2430 3 V
- supported OS: Android, iOS



**H5012** 1/-/-/60  
30 69 050 120 IP-2002ZW

- product: IP Smart Scene Switcher
- connectivity: ZigBee 2.4 GHz
- compatibility: EMOS GoSmart, TUYA, LIDL, Smartlife
- protocol: Zigbee 3.0
- pairing: automatic, manual
- use: automation
- number of control buttons: 4
- power supply: CR 2430 3 V
- supported OS: Android, iOS



**H5013** 1/-/-/60  
30 69 050 130 IP-2004ZW

- product: IP Smart Scene Switcher
- connectivity: ZigBee 2.4 GHz
- compatibility: EMOS GoSmart, TUYA, LIDL, Smartlife
- protocol: Zigbee 3.0
- pairing: automatic, manual
- use: automation
- number of control buttons: 1
- power supply: CR 2430 3 V
- supported OS: Android, iOS



**H5014** 1/-/-/60  
30 69 050 140 IP-2001ZB

- product: IP Smart Scene Switcher
- connectivity: ZigBee 2.4 GHz
- compatibility: EMOS GoSmart, TUYA, LIDL, Smartlife
- protocol: Zigbee 3.0
- pairing: automatic, manual
- use: automation
- number of control buttons: 2
- power supply: CR 2430 3 V
- supported OS: Android, iOS



**H5015** 1/-/-/60  
30 69 050 150 IP-2002ZB

- product: IP Smart Scene Switcher
- connectivity: ZigBee 2.4 GHz
- compatibility: EMOS GoSmart, TUYA, LIDL, Smartlife
- protocol: Zigbee 3.0
- pairing: automatic, manual
- use: automation
- number of control buttons: 4
- power supply: CR 2430 3 V
- supported OS: Android, iOS



**H5016** 1/-/-/60  
30 69 050 160 IP-2004ZB

# Modules GoSmart



- Remote control of connected devices
- Integration into home automation
- Variants for connection with or without the need for a neutral wire
- Easy installation under original switches
- Connection to the home network via WIFI/ZigBee protocol
- Compatibility with EMOS GoSmart products and TUYA devices
- Voice control with Google Assistant and Amazon Alexa



- product: IP switching module
  - connectivity: ZigBee 2.4 GHz
  - compatibility: EMOS GoSmart, TUYA, LIDL, Smartlife
  - control by voice assistants
  - protocol: Zigbee 3.0
  - pairing: automatic, manual
  - use: indoor
  - number of control buttons: 1
  - power supply: 230 V~/50 Hz, max. 0,3 W
- supported OS: Android, iOS



**H5101** 1/-/-/100  
30 69 051 010 IP-2101SZ



- product: IP switching module
  - connectivity: ZigBee 2.4 GHz
  - compatibility: EMOS GoSmart, TUYA, LIDL, Smartlife
  - control by voice assistants
  - protocol: Zigbee 3.0
  - pairing: automatic, manual
  - use: indoor
  - number of control buttons: 1
  - power supply: 230 V~/50 Hz, max. 0,3 W
- supported OS: Android, iOS



**H5102** 1/-/-/100  
30 69 051 020 IP-2102SZ



- product: IP switching module
  - connectivity: ZigBee 2.4 GHz
  - compatibility: EMOS GoSmart, TUYA, LIDL, Smartlife
  - control by voice assistants
  - protocol: Zigbee 3.0
  - pairing: automatic, manual
  - use: indoor
  - number of control buttons: 1
  - power supply: 230 V~/50 Hz, max. 0,3 W
- supported OS: Android, iOS



**H5103** 1/-/-/100  
30 69 051 030 IP-2103SZ



- product: IP switching module
  - connectivity: ZigBee 2.4 GHz
  - compatibility: EMOS GoSmart, TUYA, LIDL, Smartlife
  - control by voice assistants
  - protocol: Zigbee 3.0
  - pairing: automatic, manual
  - use: indoor
  - number of control buttons: 1
  - power supply: 230 V~/50 Hz, max. 0,3 W
- supported OS: Android, iOS



**H5104** 1/-/-/100  
30 69 051 040 IP-2104SZ





www.emos.eu

Order Code  
Item Number

Packaging  
Type

- product: IP switching module
  - connectivity: 2.4 GHz WIFI
  - compatibility: EMOS GoSmart, TUYA, LIDL, Smartlife
  - control by voice assistants
  - protocol: Wi-Fi
  - pairing: automatic, manual
  - use: indoor
  - number of control buttons: 1
  - power supply: 230 V~/50 Hz, max. 0,3 W
- = supported OS: Android, iOS



**H5105**  
30 69 051 050

1/-/-/100  
IP-2101SW



- product: IP switching module
  - connectivity: 2.4 GHz WIFI
  - compatibility: EMOS GoSmart, TUYA, LIDL, Smartlife
  - control by voice assistants
  - protocol: Wi-Fi
  - pairing: automatic, manual
  - use: indoor
  - number of control buttons: 1
  - power supply: 230 V~/50 Hz, max. 0,3 W
- = supported OS: Android, iOS



**H5106**  
30 69 051 060

1/-/-/100  
IP-2102SW



- product: IP dimming module
  - connectivity: ZigBee 2.4 GHz
  - compatibility: EMOS GoSmart, TUYA, LIDL, Smartlife
  - control by voice assistants
  - protocol: Zigbee 3.0
  - pairing: automatic, manual
  - use: indoor
  - number of control buttons: 1
  - power supply: 230 V~/50 Hz, max. 0,3 W
- = supported OS: Android, iOS



**H5107**  
30 69 051 070

1/-/-/100  
IP-2111DZ



- product: IP dimming module
  - connectivity: ZigBee 2.4 GHz
  - compatibility: EMOS GoSmart, TUYA, LIDL, Smartlife
  - control by voice assistants
  - protocol: Zigbee 3.0
  - pairing: automatic, manual
  - use: indoor
  - number of control buttons: 1
  - power supply: 230 V~/50 Hz, max. 0,3 W
- = supported OS: Android, iOS



**H5108**  
30 69 051 080

1/-/-/100  
IP-2112DZ



- product: IP motor module
  - connectivity: ZigBee 2.4 GHz
  - compatibility: EMOS GoSmart, TUYA, LIDL, Smartlife
  - control by voice assistants
  - protocol: Zigbee 3.0
  - pairing: automatic, manual
  - use: indoor
  - number of control buttons: 1
  - power supply: 230 V~/50 Hz, max. 0,3 W
- = supported OS: Android, iOS



**H5109**  
30 69 051 090

1/-/-/100  
IP-2121CZ





www.emos.eu

Order Code  
Item Number

Packaging  
Type

- product: IP motor module
  - connectivity: ZigBee 2.4 GHz
  - compatibility: EMOS GoSmart, TUYA, LIDL, Smartlife
  - control by voice assistants
  - protocol: Zigbee 3.0
  - pairing: automatic, manual
  - use: indoor
  - number of control buttons: 1
  - power supply: 230 V~/50 Hz, max. 0,3 W
- = supported OS: Android, iOS



**H5110**  
30 69 051 100

1/-/-/100  
IP-2122CZ



- product: IP motor module
  - connectivity: 2.4 GHz WIFI
  - compatibility: EMOS GoSmart, TUYA, LIDL, Smartlife
  - control by voice assistants
  - protocol: Wi-Fi/BLE
  - pairing: automatic, manual
  - use: indoor
  - number of control buttons: 1
  - power supply: 230 V~/50 Hz, max. 0,3 W
- = supported OS: Android, iOS



**H5111**  
30 69 051 110

1/-/-/32  
IP-2131SW



## Installation material

### Terminal blocks

- terminal blocks with brass contacts
- conductor diameter: 12×4mm<sup>2</sup>, 12×6mm<sup>2</sup>, 12×10mm<sup>2</sup>, 12×16mm<sup>2</sup>
- rated current: 32 A, 41 A, 57 A or 76 A

**A4001**  
31 46 000 250

10/-/-/800  
KL 0



product: terminal block = for conductor cross-section: 12× 1-4 mm<sup>2</sup> = current: 32 A = rated voltage: 450 V~ = packaging: 10 pcs, foil

**A4002**  
31 46 000 400

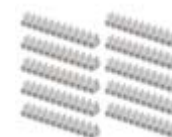

10/-/-/500  
KL 1



product: terminal block = for conductor cross-section: 12× 1.5-6 mm<sup>2</sup> = current: 41 A = rated voltage: 450 V~ = packaging: 10 pcs, foil





**A4003**      10/-/-/350  
31 46 000 600      KL 2



product: terminal block = for conductor cross-section: 12× 2.5–10 mm<sup>2</sup> = current: 57 A  
= rated voltage: 450 V~ = packaging: 10 pcs, foil

**A4004**      10/-/-/200  
31 46 001 600      KL 3



product: terminal block = for conductor cross-section: 12× 2.5–16 mm<sup>2</sup> = current: 76 A  
= rated voltage: 450 V~ = packaging: 10 pcs, foil

**A4005**      1/-/-/300  
31 46 010 400      KL 0



product: terminal block = for conductor cross-section: 12× 1–4 mm<sup>2</sup> = current: 32 A  
= rated voltage: 450 V~ = packaging: 1 pc, packet

**A4006**      1/-/-/200  
31 46 010 600      KL 1

product: terminal block = for conductor cross-section: 12× 1.5–6 mm<sup>2</sup> = current: 41 A  
= rated voltage: 450 V~ = packaging: 1 pc, packet

**A4007**      1/-/-/150  
31 46 011 000      KL 2





product: terminal block = for conductor cross-section: 12× 2.5–10 mm<sup>2</sup> = current: 57 A  
= rated voltage: 450 V~ = packaging: 1 pc, packet

## Installation material others

- safety plug + key

**A9000**      1/-/-/12  
31 99 900 000      4FF53902.431/S

product: 5× safety cap for sockets + key for the cap = type: 4FF53902.431/S = type of mounting: into a socket = version: cap for sockets + key for the cap = colour: white = packaging: 1 pc, hanging



## Transformer solders, copper, rosin

- for DIY and professionals, made in Czech Republic
- suitable for so-called soft soldering, welding smaller parts
- with 125 W input power, 4 soldering tips, LED light
- rosin, soldering tip or tin (1.5 mm diameter) also available

**A5102**

1/-/-/6

31 47 010 020

ETP 5



8 595025 358875



product: transformer soldering iron - LED lighting = number of soldering tips: 4 =  
power: 125 W = packaging: 1 pc, blister

**A5201**

5/-/-/2 500

31 47 020 010

HR5 CU



8 595025 358929



product: soldering tip copper for soldering irons 1.3 mm diameter = number of  
soldering tips: 5 = packaging: 5 pcs, PVC packet

**A5301**

1/-/-/500

31 47 030 010

KLF 16G



8 595025 358950



product: rosin for soldering = packaging: 1 pc, PVC packet

**A5401**

1/-/-/500

31 47 040 010

CN 1,5 10G



8 595025 358899



product: tube lead-free solder filled with active rosin Sn99,3Cu0,7Nip, diameter  
1,5mm, approx. 1 = packaging: 1 pc, PVC packet

# Tapes

## Electroinsulating PVC tapes

- width: 15–25 mm, length: 10–20 m, thickness: 0.13 mm
- white, red, black, brown, blue, green, yellow or mix
- meets ROHS and REACH (certification for automotive industry)
- adhesion 1.5 N/10 mm<sup>2</sup>, dielectric strength 40 kV/mm<sup>2</sup>

- tape type: PVC
- width: 19 mm
- length: 10 m
- thickness: 0.13 mm
- electric strength - minimum: 40 kV/mm
- flame tests: less than 1 second
- recommended storage temperature: 10–45 °C
- installation temperature range: -25–90 °C
- ROHS compliant

- REACH compliant
- UV resistant
- adhesive material: rubber
- intended use: cable insulation
- dimensions: 60 × 20 mm
- packaging: 10 pcs, foil



**F61912** 10/-/-/300  
20 01 191 020 19/10 CERNA

- tape type: PVC
- width: 25 mm
- length: 10 m
- thickness: 0.13 mm
- electric strength - minimum: 40 kV/mm
- flame tests: less than 1 second
- recommended storage temperature: 10–45 °C
- installation temperature range: -25–90 °C
- ROHS compliant

- REACH compliant
- UV resistant
- adhesive material: rubber
- intended use: cable insulation
- dimensions: 60 × 25 mm
- packaging: 10 pcs, foil



**F62512** 10/-/-/300  
20 01 251 020 25/10 CERNA

- tape type: PVC
- width: 15 mm
- length: 10 m
- thickness: 0.13 mm
- electric strength - minimum: 40 kV/mm
- flame tests: less than 1 second
- recommended storage temperature: 10–45 °C
- installation temperature range: -25–90 °C
- ROHS compliant

- REACH compliant
- UV resistant
- adhesive material: rubber
- intended use: cable insulation
- dimensions: 60 × 15 mm
- packaging: 10 pcs, foil



**F61511** 10/-/-/360  
20 01 151 010 15/10 BÍLÁ

- tape type: PVC
- width: 15 mm
- length: 10 m
- thickness: 0.13 mm
- electric strength - minimum: 40 kV/mm
- flame tests: less than 1 second
- recommended storage temperature: 10–45 °C
- installation temperature range: -25–90 °C
- ROHS compliant

- REACH compliant
- UV resistant
- adhesive material: rubber
- intended use: cable insulation
- dimensions: 60 × 15 mm
- packaging: 10 pcs, foil



**F61512** 10/-/-/360  
20 01 151 020 15/10 CERNA



- tape type: PVC
- width: 15 mm
- length: 10 m
- thickness: 0.13 mm
- electric strength - minimum: 40 kV/mm
- flame tests: less than 1 second
- recommended storage temperature: 10–45 °C
- installation temperature range: -25–90 °C
- ROHS compliant

- REACH compliant
- UV resistant
- adhesive material: rubber
- intended use: cable insulation
- dimensions: 60 × 15 mm
- packaging: 10 pcs, foil



**F61513** 10/-/-/360  
20 01 151 030 15/10 CERVENA



- tape type: PVC
- width: 15 mm
- length: 10 m
- thickness: 0.13 mm
- electric strength - minimum: 40 kV/mm
- flame tests: less than 1 second
- recommended storage temperature: 10–45 °C
- installation temperature range: -25–90 °C
- ROHS compliant

- REACH compliant
- UV resistant
- adhesive material: rubber
- intended use: cable insulation
- dimensions: 60 × 15 mm
- packaging: 10 pcs, foil



**F61514** 10/-/-/360  
20 01 151 040 15/10 MODRA



- tape type: PVC
- width: 15 mm
- length: 10 m
- thickness: 0.13 mm
- electric strength - minimum: 40 kV/mm
- flame tests: less than 1 second
- recommended storage temperature: 10–45 °C
- installation temperature range: -25–90 °C
- ROHS compliant

- REACH compliant
- UV resistant
- adhesive material: rubber
- intended use: cable insulation
- dimensions: 60 × 15 mm
- packaging: 10 pcs, foil



**F61515** 10/-/-/360  
20 01 151 050 15/10 ZEL/ZLUTA



- tape type: PVC
- width: 15 mm
- length: 10 m
- thickness: 0.13 mm
- electric strength - minimum: 40 kV/mm
- flame tests: less than 1 second
- recommended storage temperature: 10–45 °C
- installation temperature range: -25–90 °C
- ROHS compliant

- REACH compliant
- UV resistant
- adhesive material: rubber
- intended use: cable insulation
- dimensions: 60 × 15 mm
- packaging: 10 pcs, foil



**F61516** 10/-/-/360  
20 01 151 060 15/10 ZLUTA



- tape type: PVC
- width: 15 mm
- length: 10 m
- thickness: 0.13 mm
- electric strength - minimum: 40 kV/mm
- flame tests: less than 1 second
- recommended storage temperature: 10–45 °C
- installation temperature range: -25–90 °C
- ROHS compliant

- REACH compliant
- UV resistant
- adhesive material: rubber
- intended use: cable insulation
- dimensions: 60 × 15 mm
- packaging: 10 pcs, foil



**F61517** 10/-/-/360  
20 01 151 070 15/10 HNEDA



- tape type: PVC
- width: 15 mm
- length: 10 m
- thickness: 0.13 mm
- electric strength - minimum: 40 kV/mm
- flame tests: less than 1 second
- recommended storage temperature: 10–45 °C
- installation temperature range: -25–90 °C
- ROHS compliant

- REACH compliant
- UV resistant
- adhesive material: rubber
- intended use: cable insulation
- dimensions: 60 × 15 mm
- packaging: 10 pcs, foil



**F61519** 10/-/-/360  
20 01 151 090 15/10 GREEN



- tape type: PVC
- width: 15 mm
- length: 10 m
- thickness: 0.13 mm
- electric strength - minimum: 40 kV/mm
- flame tests: less than 1 second
- recommended storage temperature: 10–45 °C
- installation temperature range: -25–90 °C
- ROHS compliant

- REACH compliant
- UV resistant
- adhesive material: rubber
- intended use: cable insulation
- dimensions: 60 × 150 mm
- packaging: 10 pcs, foil



**F615992** 10/-/-/360  
20 01 151 092 15/10 COLOR MIX



- tape type: PVC
- width: 19 mm
- length: 20 m
- thickness: 0.13 mm
- electric strength - minimum: 40 kV/mm
- flame tests: less than 1 second
- recommended storage temperature: 10–45 °C
- installation temperature range: -25–90 °C
- ROHS compliant

- REACH compliant
- UV resistant
- adhesive material: rubber
- intended use: cable insulation
- dimensions: 70 × 20 mm
- packaging: 10 pcs, foil



**F61921** 10/-/-/200  
20 01 192 010 19/20 BILA



- tape type: PVC
- width: 19 mm
- length: 20 m
- thickness: 0.13 mm
- electric strength - minimum: 40 kV/mm
- flame tests: less than 1 second
- recommended storage temperature: 10–45 °C
- installation temperature range: -25–90 °C
- ROHS compliant

- REACH compliant
- UV resistant
- adhesive material: rubber
- intended use: cable insulation
- dimensions: 70 × 20 mm
- packaging: 10 pcs, foil



**F61922** 10/-/-/200  
20 01 192 020 19/20 CERNA



- tape type: PVC
- width: 19 mm
- length: 20 m
- thickness: 0.13 mm
- electric strength - minimum: 40 kV/mm
- flame tests: less than 1 second
- recommended storage temperature: 10–45 °C
- installation temperature range: -25–90 °C
- ROHS compliant

- REACH compliant
- UV resistant
- adhesive material: rubber
- intended use: cable insulation
- dimensions: 70 × 20 mm
- packaging: 10 pcs, foil



**F61923** 10/-/-/200  
20 01 192 030 19/20 CERVENA



- tape type: PVC
- width: 19 mm
- length: 20 m
- thickness: 0.13 mm
- electric strength - minimum: 40 kV/mm
- flame tests: less than 1 second
- recommended storage temperature: 10–45 °C
- installation temperature range: -25–90 °C
- ROHS compliant

- REACH compliant
- UV resistant
- adhesive material: rubber
- intended use: cable insulation
- dimensions: 70 × 20 mm
- packaging: 10 pcs, foil



**F61924** 10/-/-/200  
20 01 192 040 19/20 MODRA



- tape type: PVC
- width: 19 mm
- length: 20 m
- thickness: 0.13 mm
- electric strength - minimum: 40 kV/mm
- flame tests: less than 1 second
- recommended storage temperature: 10–45 °C
- installation temperature range: -25–90 °C
- ROHS compliant

- REACH compliant
- UV resistant
- adhesive material: rubber
- intended use: cable insulation
- dimensions: 70 × 20 mm
- packaging: 10 pcs, foil



**F61925** 10/-/-/200  
20 01 192 050 19/20 ZEL/ZLUTA



- tape type: PVC
- width: 19 mm
- length: 20 m
- thickness: 0.13 mm
- electric strength - minimum: 40 kV/mm
- flame tests: less than 1 second
- recommended storage temperature: 10–45 °C
- installation temperature range: -25–90 °C
- ROHS compliant

- REACH compliant
- UV resistant
- adhesive material: rubber
- intended use: cable insulation
- dimensions: 70 × 20 mm
- packaging: 10 pcs, foil



**F61926** 10/-/-/200  
20 01 192 060 19/20 ZLUTA



- tape type: PVC
- width: 19 mm
- length: 20 m
- thickness: 0.13 mm
- electric strength - minimum: 40 kV/mm
- flame tests: less than 1 second
- recommended storage temperature: 10–45 °C
- installation temperature range: -25–90 °C
- ROHS compliant

- REACH compliant
- UV resistant
- adhesive material: rubber
- intended use: cable insulation
- dimensions: 70 × 20 mm
- packaging: 10 pcs, foil



**F61927** 10/-/-/200  
20 01 192 070 19/20 BROWN





- tape type: PVC
- width: 19 mm
- length: 20 m
- thickness: 0.13 mm
- electric strength - minimum: 40 kV/mm
- flame tests: less than 1 second
- recommended storage temperature: 10–45 °C
- installation temperature range: -25–90 °C
- ROHS compliant

- REACH compliant
- UV resistant
- adhesive material: rubber
- intended use: cable insulation
- dimensions: 70 × 20 mm
- packaging: 10 pcs, foil



**F61929** 10/-/-/200  
20 01 192 090 19/20 ZELENA



- tape type: PVC
- width: 19 mm
- length: 20 m
- thickness: 0.13 mm
- electric strength - minimum: 40 kV/mm
- flame tests: less than 1 second
- recommended storage temperature: 10–45 °C
- installation temperature range: -25–90 °C
- ROHS compliant

- REACH compliant
- UV resistant
- adhesive material: rubber
- intended use: cable insulation
- dimensions: 70 × 200 mm
- packaging: 10 pcs, foil



**F61999** 10/-/-/200  
20 01 192 099 19/20 MIX 10KS



## Other tapes

- textile, marking and reflective tapes also available
- self-amalgamating tapes: material rubber or silicone
- universal DUCT TAPE: strong, high adhesion, water-tightness
- reflective tapes: increase biker, pedestrian and pram safety
- double-sided acrylic tapes: high adhesion and flexibility

length: 1 m = recommended storage temperature: 10–45 °C = adhesive material: synthetic adhesive = UV resistant = packaging: 1 pc, paper box = intended use: pools, hobby, workshop, garden = installation temperature range: -25–90 °C = ROHS compliant = width: 100 mm = thickness: 0.7 mm = tape type: PVC base



**F6100** 1/-/-/32  
20 05 061 000 POOLREPAIR  
TRANSPARENT



length: 1 m = recommended storage temperature: 10–45 °C = adhesive material: synthetic adhesive = UV resistant = packaging: 1 pc, paper box = intended use: pools, hobby, workshop, garden = installation temperature range: -25–90 °C = ROHS compliant = width: 100 mm = thickness: 0.7 mm = tape type: PVC base



**F6110** 1/-/-/32  
20 05 061 100 POOLREPAIR  
BLACK



length: 25 m = recommended storage temperature: 10–45 °C = adhesive material: acrylic = UV resistant = packaging: 1 pc, paper box = intended use: repairs of all types of polycarbonates, repairs of glass panes = installation temperature range: -25–90 °C = ROHS compliant = width: 50 mm = thickness: 0.15 mm = tape type: PE base



**F6200** 1/-/-/30  
20 05 062 000 GREENHOUSE TAPE

length: 3 m = recommended storage temperature: 10–45 °C = adhesive material: acrylic = packaging: 1 pc, paper box = intended use: hobby, home interior = installation temperature range: 5–80 °C = ROHS compliant = width: 20 mm = thickness: 1.00 mm = tape type: PE foam



**F6090** 1/-/-/80  
20 05 060 900 IZOTAPE FOAM

length: 3 m = recommended storage temperature: 10–45 °C = adhesive material: acrylic = packaging: 1 pc, paper box = intended use: hobby, home interior = installation temperature range: 5–80 °C = ROHS compliant = width: 30 mm = thickness: 2 mm = tape type: acrylic double-sided tape



**F6300** 1/-/-/30  
20 05 063 000 EM-2303N

tape type: asphalt textile tape = width: 15 mm = length: 15 m = thickness: 0.4 mm = electric strength - minimum: 1 kV/mm = recommended storage temperature: -5 °C to +40 °C = installation temperature range: 5–40 °C = UV resistant = adhesive material: asphalt = integrated textile mesh = dimensions: 80 × 17 mm = packaging: 1 pc, PVC hanging



**F6515** 1/-/-/60  
20 02 151 520 15/15 CERNA

tape type: asphalt textile tape = width: 19 mm = length: 10 m = thickness: 0.4 mm = electric strength - minimum: 1 kV/mm = recommended storage temperature: -5 °C to +40 °C = installation temperature range: 5–40 °C = UV resistant = adhesive material: asphalt = integrated textile mesh = dimensions: 70 × 17 mm = packaging: 1 pc, PVC hanging



**F6910** 1/-/-/60  
20 02 191 020 19/10 CERNA

tape type: self-amalgamating tape = width: 19 mm = length: 10 m = thickness: 0.76 mm = electric strength - minimum: 14 kV/mm = recommended storage temperature: -50 °C to +95 °C = installation temperature range: 5-95 °C = adhesive material: rubber = intended use: sealing, repairs = dimensions: 120 × 20 mm = packaging: 1 pc, paper box



**F51912** 1/-/5/30  
20 03 191 020 19/10  
SELFUSING

tape type: self-amalgamating tape = width: 25 mm = length: 5 m = thickness: 0.76 mm = electric strength - minimum: 14 kV/mm = recommended storage temperature: -50 °C to +95 °C = installation temperature range: 5-95 °C = adhesive material: rubber = intended use: sealing, repairs = dimensions: 95 × 28 mm = packaging: 1 pc, paper box



**F52502** 1/-/5/30  
20 03 250 520 25/5 SELFUSING

tape type: silicone vulcanisation = width: 25 mm = length: 3 m = thickness: 0.60 mm = electric strength - minimum: 8 kV/mm = flame tests: less than 1 second = installation temperature range: -60-260 °C = UV resistant = creates pressure-tight joint = intended use: hobby, workshop, garden, repair in vehicle engine compartment, emergency repair of pipes, hoses = dimensions: 60 × 30 mm = packaging: 1 pc, blister



**F52503** 1/-/20/80  
20 03 250 320 25/3 SILICONE

tape type: universal adhesive DUCT TAPE = width: 48 mm = length: 10 m = thickness: 0.21 mm = recommended storage temperature: -20 °C to +80 °C = installation temperature range: 5-80 °C = UV resistant = adhesive material: synthetic rubber = intended use: hobby, workshop, garden = integrated textile mesh: 70 fibers = dimensions: 105 × 48 mm = packaging: 10 pcs, display box



**F6030** 10/-/-/50  
20 02 502 002 48/10 UNITAPE

tape type: LDPE (low-density polyethylene) warning tape = width: 75 mm = length: 250 m = thickness: 0.03 mm = recommended storage temperature: 5-30 °C = installation temperature range: 5-30 °C = UV resistant = intended use: border of excavations, demarcation of building spaces, sports tracks, various dangerous locations = dimensions: 140 × 75 mm = packaging: 1 pc, paper unwinding mechanism

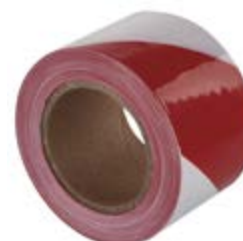

**F87525** 1/-/-/18  
20 04 752 500 75/250 BARRIER

tape type: acrylic double-sided tape = width: 12 mm = length: 3 m = thickness: 1.00 mm = recommended storage temperature: 5-40 °C = installation temperature range: 5-40 °C = UV resistant = adhesive material: acrylic = intended use: hobby, workshop, garden = dimensions: 88 × 12 mm = packaging: 1 pc, blister



**F6060** 1/-/10/60  
20 06 000 000 12/3 ACRYL

tape type: acrylic double-sided tape = width: 18 mm = length: 3 m = thickness: 1.00 mm = recommended storage temperature: 5-40 °C = installation temperature range: 5-40 °C = UV resistant = adhesive material: acrylic = intended use: hobby, workshop, garden = dimensions: 88 × 18 mm = packaging: 1 pc, blister



**F6080** 1/-/10/60  
20 06 000 010 18/3 ACRYL

tape type: reflexive safety tape = width: 25 mm = length: 2 m = thickness: 0.19 mm = recommended storage temperature: -20 °C to +80 °C = installation temperature range: -25-90 °C = UV resistant = adhesive material: rubber = intended use: hobby, cycling, safety element = dimensions: 53 × 53 × 25 mm = packaging: 12 pcs, display box



**F6070** 12/-/-/216  
20 05 000 010 25/2 REFLEX TAPE



Order Code	Item Number	page	Order Code	Item Number	page	Order Code	Item Number	page	Order Code	Item Number	page	Order Code	Item Number	page	Order Code	Item Number	page
A1396	31 04 139 600	375	B02114	10 13 124 100	26	B15431	10 42 232 511	43	B9684	12 01 003 700	63	EV106	26 17 010 600	254	H4065	30 24 040 650	349
A1396.1	31 04 139 611	375	B02118	10 13 128 100	27	B15441	10 42 233 011	43	B9685	12 01 003 800	63	EV112	26 17 010 902	23	H5001	30 69 050 010	15
A1396.2	19 50 011 207	375	B0211V	10 13 126 000	27	B15451	10 42 232 011	43	B9691	12 01 004 300	62	EV112	26 17 010 902	255	H5001	30 69 050 010	341
A1398	31 04 139 800	374	B02212	10 14 222 000	27	B15601	10 42 161 611	40	C0024	28 04 000 013	346	F51912	20 03 191 020	388	H5011	30 69 050 110	14
A1398.1	31 04 139 811	374	B02214	10 13 224 100	27	B15651	10 42 121 611	39	C0025	28 04 000 013	346	F52502	20 03 250 520	388	H5011	30 69 050 110	375
A1398.2	19 50 011 202	374	B02218	10 13 228 100	28	B1570	10 42 162 015	40	C0030	28 04 000 030	346	F52503	20 03 250 320	388	H5012	30 69 050 120	14
A1398.3	19 50 011 203	375	B0221V	10 13 226 000	27	B15701	10 42 162 011	40	C5109	31 32 510 900	141	F6030	20 02 502 002	388	H5012	30 69 050 120	376
A1398.4	19 50 011 204	375	B02312	10 13 322 100	28	B15711	10 42 103 011	39	D4ZR01	15 50 044 028	13	F6060	20 06 000 000	389	H5013	30 69 050 130	14
A1399	19 50 011 201	374	B02412	10 13 422 100	28	B15771	10 42 247 711	44	D4ZR01	15 50 044 028	238	F6070	20 05 000 010	389	H5013	30 69 050 130	376
A3004	31 16 300 400	326	B02511	10 13 521 100	28	B1585	10 42 245 015	44	D4ZR02	15 50 044 029	13	F6080	20 06 000 010	389	H5014	30 69 050 140	15
A3010	31 16 301 000	326	B03112	10 13 122 000	24	B15851	10 42 245 011	44	D4ZR02	15 50 044 029	239	F6090	20 05 060 900	387	H5014	30 69 050 140	376
A3366	31 16 336 600	326	B03114	10 13 124 000	24	B15951	10 42 163 221	41	D4ZR03	15 50 044 030	13	F6100	20 05 061 000	386	H5015	30 69 050 150	15
A3369	31 16 336 900	326	B03146	10 17 101 000	25	B24294	10 33 224 170	56	D4ZR03	15 50 044 030	239	F6110	20 05 061 100	386	H5015	30 69 050 150	376
A4001	31 46 000 250	379	B03212	10 13 222 000	25	B24294	10 33 224 170	64	D4ZR04	15 50 044 031	13	F61511	20 01 151 010	382	H5016	30 69 050 160	15
A4002	31 46 000 400	379	B03214	10 13 224 000	25	B25112	10 32 122 090	54	D4ZR04	15 50 044 031	239	F61512	20 01 151 020	383	H5016	30 69 050 160	376
A4003	31 46 000 600	380	B03246	10 17 201 000	25	B25114	10 32 124 090	54	DCCV06	15 50 001 005	241	F61513	20 01 151 030	383	H5020	30 69 052 010	9
A4004	31 46 001 600	380	B03312	10 13 322 000	25	B2511V	10 32 126 090	54	DCCV07	15 50 001 006	241	F61514	20 01 151 040	383	H5020	30 69 052 010	356
A4005	31 46 010 400	380	B03412	10 13 422 000	26	B25162	10 32 122 062	53	DCCV11	15 50 001 010	242	F61515	20 01 151 050	383	H5021	30 69 052 020	9
A4006	31 46 010 600	380	B03511	10 13 521 000	26	B25182	10 32 122 080	53	DCCV12	15 50 001 011	242	F61516	20 01 151 060	383	H5021	30 69 052 020	356
A4007	31 46 011 000	380	B0526B	16 13 052 600	71	B25184	10 32 124 081	54	DCCV13	15 50 001 012	242	F61517	20 01 151 070	384	H5022	30 69 052 030	16
A5102	31 47 010 020	381	B0527B	16 13 052 700	71	B25212	10 32 222 211	55	DCCV19	15 50 000 056	242	F61519	20 01 151 090	384	H5022	30 69 052 030	341
A5201	31 47 020 010	381	B0531B	16 13 053 100	70	B25214	10 32 224 210	55	DCCV20	15 50 000 057	242	F61592	20 01 151 092	384	H5023	30 69 052 030	17
A5301	31 47 030 010	381	B0532B	16 13 053 200	70	B2521V	10 32 226 212	55	DCCV21	15 50 001 024	242	F61912	20 01 191 020	382	H5023	30 69 052 030	346
A5401	31 47 040 010	381	B0543B	16 13 054 300	70	B25232	10 32 222 131	54	DCCV22	15 50 001 029	242	F61921	20 01 192 010	384	H5101	30 69 051 010	17
A6000.1	19 06 010 501	372	B0545B	16 13 054 500	70	B25272	10 32 222 260	55	DCLV02	15 50 001 013	241	F61922	20 01 192 020	384	H5101	30 69 051 010	377
A6000.3	19 06 010 507	373	B1110	10 11 102 000	36	B25274	10 32 224 260	55	DCLV02	15 50 001 014	241	F61923	20 01 192 030	385	H5102	30 69 051 020	17
A6000.5	19 06 010 512	372	B11202	10 11 202 001	36	B2527V	10 32 226 260	56	DCPM01	15 50 004 000	240	F61924	20 01 192 040	385	H5102	30 69 051 020	377
A6002.0	19 06 010 504	372	B12104	10 12 104 000	34	B2533	10 32 322 301	56	DCPV01	15 50 001 023	240	F61925	20 01 192 050	385	H5103	30 69 051 030	17
A6002.2	19 06 010 510	373	B1210F	10 12 109 002	34	B2543	10 32 422 300	56	F61926	20 01 192 060	385	F61926	20 01 192 060	385	H5103	30 69 051 030	377
A6003.0	19 06 300 103	372	B1211	10 12 114 000	34	B2552	10 32 521 021	56	F61927	20 01 192 070	385	F61927	20 01 192 070	385	H5104	30 69 051 040	18
A6003.1	19 06 300 109	373	B1220	10 12 204 000	33	B26184	10 32 124 080	52	F61929	20 01 192 090	386	F61929	20 01 192 090	386	H5104	30 69 051 040	377
A6004.0	19 06 300 102	372	B1220F	10 12 209 002	34	B2618V	10 32 126 080	52	F61999	15 50 005 019	241	F6200	20 05 062 000	387	H5105	30 69 051 050	18
A6004.1	19 06 300 101	372	B1221	10 12 214 000	34	B26204	10 32 224 200	52	DCPZ01	15 50 005 009	240	F6200	20 05 062 000	387	H5105	30 69 051 050	378
A6004.2	19 06 300 100	372	B1230	10 12 302 000	35	B2620V	10 32 226 200	53	DCPZ02	15 50 005 001	240	F62512	20 01 251 020	382	H5106	30 69 051 060	18
A6004.3	19 06 300 104	372	B1231	10 12 312 000	35	B2629	10 32 224 201	53	E00387	26 93 000 240	250	F6300	20 05 063 000	387	H5106	30 69 051 060	378
A6004.4	19 06 300 105	372	B1240	10 12 402 000	35	B3357F1	10 43 035 721	49	E0041	26 03 013 000	247	F6515	20 02 151 020	387	H5107	30 69 051 070	18
A6004.5	19 06 300 108	373	B1241	10 12 412 000	35	B3364F1	10 43 036 431	50	E0042	26 03 118 000	247	F6910	20 02 191 020	387	H5107	30 69 051 070	378
A6004.6	19 06 300 107	373	B1250	10 12 501 000	35	B3377F1	10 43 037 721	50	E0086	26 18 002 600	256	F7825	20 04 752 500	388	H5108	30 69 051 080	18
A6004.7	19 06 300 106	374	B1251	10 12 511 000	36	B3389F1	10 43 038 921	50	E0107	26 03 115 000	246	G1110	14 54 007 100	236	H5108	30 69 051 080	378
A6004.8	19 06 300 110	374	B1260	10 12 601 000	36	B3392F1	10 43 039 221	50	E0114	26 03 117 000	247	G1120	14 54 007 200	236	H5109	30 69 051 090	19
A6004.9	19 06 300 111	374	B1300	10 21 002 315	45	B3510	10 44 001 016	51	E0117N	26 06 003 000	245	G1125	14 54 007 250	236	H5109	30 69 051 090	378
A6100.0	19 06 200 100	371	B13001	10 21 002 311	45	B3512	10 44 001 216	51	E0121	26 03 016 001	248	G1130	14 54 008 100	237	H5110	30 69 051 100	19
A6100.1	19 06 200 101	371	B1301	10 21 002 715	46	B3513	10 44 001 316	51	E0127	26 03 121 000	248	G1150	14 54 009 200	237	H5110	30 69 051 100	379
A6100.2	19 06 200 102	371	B13011	10 21 002 711	46	B3575	10 44 067 516	51	E0129	26 03 119 002	246	G1160	14 54 010 100	237	H5111	30 69 051 110	19
A6100.3	19 06 200 103	372	B1302	10 21 001 115	46	B50224	16 04 822 110	66	E0202	26 05 004 000	253	G1180	14 54 012 100	237	H5111	30 69 051 110	379
A6100.4	19 06 200 104	371	B13021	10 21 001 111	46	B50444	16 04 844 110	66	E03070	26 93 000 180	250	G1190	14 54 013 100	238	H7009	30 70 000 009	346
A6100.5	19 06 200 105	373	B1303	10 21 047 612	46	B50449	16 04 844 100	66	E0345	26 03 203 000	248	G1210	14 54 014 100	238	H8013	30 80 000 013	346
A6100.6	19 06 200 106	373	B1305	10 21 091 012	47	B50457	16 04 845 210	66	E0352	26 06 166 000	245	G1240	14 54 015 100	237	J0102	25 04 500 110	337
A6100.7	19 06 200 107	373	B1306	10 21 002 512	47	B50460	16 04 846 114	66	E0387	26 06 176 000	245	H1085	30 10 000 291	344	J0103	25 04 600 110	337
A6100.8	19 06 200 108	373	B1325	10 41 062 511	49	B50829	16 04 882 110	67	E0422	26 03 016 002	248	H1086	30 10 000 292	344	J0104	25 04 700 110	337
A6100.9	19 06 200 109	373	B1376	10 41 007 615	48	B51214	16 04 821 110	65	E05018	26 93 000 120	249	H1141	30 10 001 151	344	J0197	25 03 000 100	336
A6110	31 05 213 050	288	B13762	10 41 007 611	47	B53450	16 04 845 111	65	E06016	26 93 000 230	250	H2017	30 10 002 017	344	J0198	25 03 000 400	336
A6111	31 05 213 051	288	B13763	10 41 007 601	49	B53455	16 04 845 111	65	E06018	26 93 000 220	250	H2050	30 10 002 050	343	J0199	25 04 200 100	336
A6114	31 05 213 054	288	B13861	10 41 018 611	48	B53457	16 04 845 112	65	E08400	26 93 000 160	250	H3010	30 10 003 010	342	J0200	25 01 000 100	334
A6115	31 05 213 055	288	B1389	10 41 018 910	48	B56499	16 04 849 120	64	E2157	26 03 015 000	253	H3015	30 10 003 015	342	J0203	25 01 000 200	335
A6210	31 06 213 240	287	B13892	10 41 018 911	48	B6305B	16 11 630 500	68	E3003	26 06 153 000	244	H3016	30 10 003 016	343	J0220J	25 01 100 10	





Order Code	Item Number	page	Order Code	Item Number	page	Order Code	Item Number	page	Order Code	Item Number	page	Order Code	Item Number	page	Order Code	Item Number	page
J5712	25 08 100 200	339	N3113	17 03 225 021	72	P09240M	19 28 044 001	280	P3542	14 41 317 000	88	P56402	21 01 501 020	368	R5602.2	18 07 300 300	306
J5802	25 07 100 600	337	N9221	16 03 026 000	67	P09250	19 28 045 000	280	P3819	14 40 033 100	96	P56405	21 05 564 000	22	R5610	18 07 300 200	304
J5803	25 07 100 700	338	N9321	16 03 027 000	67	P092501	19 28 045 003	279	P3848A	14 40 093 109	100	P5640S	21 05 564 000	369	R5610.2	18 07 300 301	306
J5810	17 02 010 035	339	N9331	16 03 028 000	67	P1320	19 23 130 000	272	P3861	14 40 032 202	85	P56450	21 01 505 003	368	R5639	18 07 200 100	304
J58133	17 02 010 034	339	N9341	16 03 029 000	68	P1321	19 22 130 150	266	P3862	14 40 032 400	85	P56500	21 01 505 000	368	R5639.2	18 07 201 000	306
J6030	25 21 000 030	340	N9361	16 03 030 000	68	P1321PD	19 02 330 154	267	P3887	14 40 812 900	101	P56500S	21 04 103 000	8	R5850	18 07 200 500	304
J60110	25 21 000 110	340	P0003C	19 04 030 000	281	P1321R	19 22 130 156	264	P3888	14 40 813 100	93	P56500S	21 04 103 000	370	R5850.2	18 07 100 803	306
J60120	25 21 000 120	340	P0004C	19 04 040 000	281	P1322	19 22 130 200	266	P3889	14 40 833 100	99	P56501	21 04 101 000	368	R5851	18 07 200 600	304
J60130	25 21 000 130	340	P00242	19 25 030 020	283	P1323R	19 22 130 308	264	P3894	14 40 813 110	84	P56502	21 01 505 006	369	R5852	18 07 200 700	304
J6014	25 20 236 400	333	P00252	19 25 030 030	283	P1325R	19 22 130 508	264	P3897	14 40 813 130	100	P5660FR	21 06 000 100	366	R5852.2	18 07 100 804	306
J60140	25 21 000 140	340	P00262	19 25 030 040	283	P14201	19 22 341 000	262	P3920	14 46 002 000	95	P5681	21 01 103 000	365	S00003	24 35 724 032	291
J60170	25 21 000 170	340	P00272	19 25 030 050	283	P1421	19 22 140 153	268	P3921	14 46 002 100	95	P5682	21 01 104 000	365	S03030	24 21 150 212	289
K0101	18 21 000 100	301	P00282	19 25 030 060	283	P1421R	19 22 140 152	264	P3922	14 46 002 200	95	P5683	21 01 107 000	365	S03030N	24 21 130 213	289
K0102	18 21 000 500	302	P00292	19 25 030 090	283	P1422	19 22 140 200	266	P3923	14 46 002 300	95	P5684	21 01 108 000	366	S03031N	24 21 130 214	289
K0103	18 21 000 700	300	P0034	19 06 110 200	282	P14231	19 22 140 302	262	P4006	14 47 003 100	85	P5685	21 01 109 000	366	S03050	24 21 150 212	289
K0141	18 21 000 400	301	P0038	19 06 110 300	282	P1423R	19 22 140 303	264	P4008	14 47 013 200	84	P5686	21 01 110 000	366	S03050N	24 21 150 213	289
K0151	18 21 000 600	301	P0039	19 06 100 050	282	P14251	19 22 340 501	262	P4104	14 48 000 040	103	P57001	34 01 000 010	355	S03130	24 25 130 220	290
K0201	18 21 100 100	301	P0047	19 26 010 100	282	P1425R	19 22 140 503	264	P4112	14 40 833 200	92	P57002	34 01 000 020	355	S03130N	24 25 130 210	291
K0202	18 21 100 200	301	P0049	19 26 010 200	282	P1521	19 22 150 000	272	P4113	14 40 814 200	92	P5705	34 02 005 000	351	S03150	24 25 150 230	290
K0301	18 21 000 800	302	P0050	19 06 100 060	282	P1521R	19 22 150 154	264	P4203	14 49 000 030	93	P5712	34 02 012 000	351	S03150N	24 25 150 210	291
K0311	18 21 000 300	302	P0055N	19 10 000 800	284	P1522	19 22 150 200	267	P4205	14 49 000 050	93	P5723	34 02 107 000	351	S03210N	24 25 210 210	291
K0312	18 21 100 301	302	P0056N	19 10 000 900	284	P1523CU	19 22 150 306	268	P4518	14 50 000 180	91	P5723T	34 02 108 000	354	S03230	24 25 230 210	291
K1331	18 04 100 100	303	P0063	19 05 120 010	283	P1523PD	19 22 150 305	268	P4525	14 50 000 240	91	P5727	34 02 025 000	350	S03230N	24 25 230 210	291
K1331.2	18 04 100 701	305	P0066	19 06 100 090	282	P1523RD	19 22 150 307	268	P4531	14 50 000 280	91	P5727T	34 02 112 000	354	S03250	24 25 250 210	290
K1421	18 04 100 300	303	P0068	19 05 111 001	285	P1523RU	19 22 150 304	265	P4532	14 50 000 290	91	P5728	34 02 113 000	354	S03250N	24 25 250 210	291
K1421.2	18 04 100 702	305	P0069	19 05 120 030	286	P1525R	19 22 150 508	265	P4533	14 50 000 300	92	P5728T	34 02 113 000	354	S03350	24 21 230 230	289
K1451	18 04 100 500	303	P0072	19 05 010 003	282	P1621	19 22 160 153	268	P4534	14 50 000 310	90	P5729	34 02 044 000	352	S03350N	24 21 250 230	289
K1451.2	18 04 100 703	305	P0120R	19 21 011 002	271	P1621R	19 22 160 152	265	P4535	14 40 004 901	91	P5729B	34 02 121 000	352	S03430	24 25 430 230	290
K1731	18 04 000 100	303	P0121	19 22 010 150	267	P1622	19 22 160 200	267	P4536	14 50 000 320	89	P5729T	34 02 114 000	354	S03450	24 25 450 230	290
K1731.2	18 04 000 600	305	P01215R	19 21 011 502	271	P1623R	19 22 160 302	265	P4537	14 50 000 350	92	P5730	34 02 115 000	351	S08272	24 02 720 132	293
K1821	18 04 000 300	303	P0122	19 21 010 202	271	P1625R	19 22 160 502	265	P4538	14 50 000 360	92	P5731	34 02 116 000	352	S08273	24 02 730 132	293
K1821.2	18 04 000 601	305	P01220R	19 21 012 001	271	P19220	19 28 545 001	278	P4539	14 50 000 390	90	P5732T	34 02 117 001	355	S09272	24 02 720 232	293
K1851	18 04 000 500	303	P01225R	19 21 012 500	271	P19221	19 28 545 011	278	P4540	14 50 000 291	90	P5733G	34 02 124 000	353	S09273	24 02 730 232	293
K1851.2	18 04 000 602	305	P01230R	19 21 013 001	272	P19222	19 28 545 021	278	P4541	14 50 000 292	90	P5733S	34 02 123 000	352	S10000	23 33 101 070	320
K7311	18 07 100 300	303	P0123R	19 21 013 002	271	P19223	19 28 545 003	277	P4542	14 50 000 420	89	P5733W	34 02 122 000	352	S10100	23 33 101 011	319
K7321	18 07 100 400	304	P0125R	19 21 010 503	271	P19224	19 28 544 000	277	P4543	14 50 000 430	89	P5734	34 02 125 000	353	S10101	23 33 101 016	319
K7321.2	18 07 100 800	305	P0127R	19 21 010 701	271	P192250	19 28 432 500	275	P4702	14 40 013 114	84	P5734B	34 02 126 000	353	S10102	23 33 101 013	319
K7331	18 07 100 500	304	P01303	19 02 010 300	261	P19427	19 28 042 507	279	P4703	14 40 013 115	100	P5734T	34 02 126 001	355	S10103	23 33 101 014	319
K7331.2	18 07 100 801	305	P01320R	19 01 012 016	261	P19510	19 28 141 000	281	P4704	14 40 813 150	83	P5750	34 02 118 000	349	S10110	23 33 101 015	319
K7351	18 07 100 700	304	P01510W	19 21 611 000	270	P19515	19 28 141 500	281	P4705	14 40 813 160	100	P5750.2R	34 02 120 000	350	S10300	23 33 101 031	319
K7351.2	18 07 100 802	306	P01520W	19 21 612 000	270	P19625	19 28 542 500	278	P4706	14 40 013 116	100	P5750.2T	34 02 119 000	349	S10310	23 33 101 032	319
K9304	18 11 000 200	359	P01805	19 21 010 504	269	P19733	19 28 733 300	275	P4710	14 39 011 900	102	P5750T	34 02 118 001	353	S10500	23 33 101 051	319
KE1210	32 33 012 100	259	P01810R	19 21 011 003	269	P2312	14 50 000 380	94	P4711	14 39 013 900	102	P5760T	34 02 060 000	350	S10510	23 33 101 052	320
KE1240	32 33 012 400	258	P01820	19 21 012 000	269	P2313	14 50 000 400	94	P4712	14 39 013 901	102	P5763R	34 02 060 002	350	S11000	23 33 101 100	320
KE1280	32 33 012 800	258	P01825R	19 21 012 502	269	P2398	14 33 010 008	103	P4713	14 40 812 903	101	P5763S	34 02 060 001	350	S1111	24 00 517 252	293
KE1916	32 33 019 160	259	P01830	19 21 013 000	269	P3212	14 50 000 380	94	P4714	14 50 000 410	101	P5765	34 02 060 001	350	S11370	24 17 715 202	292
KE2981	32 33 029 810	258	P0221U	19 02 020 150	267	P3312	14 40 012 111	83	P4715	14 40 113 100	101	P5822	21 01 000 020	286	S12252	24 01 520 132	292
KE4910	32 33 049 100	259	P0222CQ	19 22 220 200	268	P3313	14 40 012 112	83	P54212	19 09 040 202	273	P8105	14 51 703 500	77	S14312	24 13 120 132	294
KE4911	32 33 049 110	259	P03200	19 23 030 000	272	P3314	14 40 012 113	83	P54225	19 09 480 301	273	P8107	14 51 710 700	77	S14313	24 13 130 132	294
KE4912	32 33 049 120	259	P0321	19 22 030 150	266	P3315	14 40 013 125	83	P5521N	19 27 110 012	284	P8502	14 51 701 200	76	S14315	24 13 150 132	294
KE4913	32 33 049 130	260	P0321R	19 22 030 153	263	P3316	14 40 014 100	82	P5522	19 27 010 010	285	P8504	14 51 703 300	76	S14322	24 13 220 132	294
KE4914	32 33 049 140	260	P0322	19 22 030 200	266	P3317	14 40 011 500	82	P5523N	19 27 010 023	285	P8506	14 51 703 200	75	S14323	24 13 230 132	294
KE6820	32 33 068 200	258	P0323R	19 22 030 308	263	P3318	14 40 011 100	82	P5525	19 27 110 020	285	P8507	14 51 703 110	76	S14325	24 13 250 132	294
KE7955N	32 33 079 551	260	P0325R	19 22 030 508	263	P3319	14 40 011 203	82	P5526N	19 27 110 033	285	P8508	14 51 703 402	76	S14372	24 13 720 132	293
KT2244	32 32 224 400	257	P0421	19 22 040 150	266	P3320	14 40 011 300	81	P5531	19 27 110 035	285	P8511	14 51 704 100	75	S14373	24 13 730 132	293
KT2265	32 32 226 500	256	P042190U	19 22 040 191	267	P33210											



Order Code	Item Number	page	Order Code	Item Number	page	Order Code	Item Number	page	Order Code	Item Number	page	Order Code	Item Number	page	Order Code	Item Number	page
S5131	23 05 050 200	313	SM7004B	23 35 070 420	322	ZB3114	15 44 203 320	174	ZF5168	15 25 283 417	106	ZM5135	15 39 085 120	189	ZQ4011	15 25 733 270	126
S5141	23 05 100 200	312	SM7004W	23 35 070 410	322	ZB3124	15 44 203 321	174	ZF5240	15 25 283 415	106	ZM5143	15 39 087 210	189	ZQ4013	15 25 733 463	126
S5194	23 05 059 009	316	SM7008BL	23 35 076 021	325	ZB3214	15 44 103 630	180	ZF5240	15 25 283 416	107	ZM5145	15 39 085 210	189	ZQ4E21	15 25 733 289	126
S5213	23 05 058 041	311	SM7009BL	23 35 076 020	325	ZB3224	15 44 103 631	180	ZF5D22	15 25 743 203	107	ZM5153	15 39 087 280	189	ZQ4E23	15 25 733 482	126
S5231S	23 05 050 201	313	SM7013W	23 35 071 310	324	ZB3524	15 44 203 322	177	ZF5D23	15 25 733 497	107	ZM5155	15 39 085 280	189	ZQ5E21	15 25 733 277	116
S5241S	23 05 100 201	313	SM7015W	23 35 076 014	324	ZC0105	15 45 000 050	227	ZF5D42	15 25 743 204	107	ZM5162	15 39 087 301	186	ZQ5E23	15 25 733 470	115
S5252	23 05 500 000	314	SM7021BL	23 35 072 100	323	ZC0106	15 45 000 060	227	ZF5D42.2	15 25 743 207	108	ZM5163	15 39 087 451	187	ZQ5E31	15 25 733 278	116
S5253	23 05 500 002	315	SM7022BL	23 35 072 200	323	ZC0108	15 45 000 080	226	ZF5D43	15 25 743 498	108	ZM5165	15 39 084 002	185	ZQ5E33	15 25 733 471	116
S5261	23 05 113 000	311	SM7023	23 35 072 310	324	ZC0109	15 45 000 090	226	ZF5D52	15 25 743 205	108	ZM5166	15 39 084 003	185	ZQ5E41	15 25 733 279	116
S5262	23 05 113 002	312	SM7025BL	23 35 072 501	323	ZC0110	15 45 000 100	226	ZF5D53	15 25 733 499	108	ZM5167	15 39 087 000	185	ZQ5E41.3	15 25 733 282	116
S5265	23 05 113 500	312	SM7025W	23 35 072 500	322	ZC0111	15 45 000 110	227	ZF5D62	15 25 743 206	108	ZM5168	15 39 094 300	186	ZQ5E43	15 25 733 472	116
S5266	23 05 113 502	312	SM7026	23 35 076 011	323	ZC0114	15 45 000 140	228	ZF5D63	15 25 743 400	109	ZM5169	15 39 094 450	186	ZQ5E43.3	15 25 733 475	116
S5268	23 05 113 003	312	SM7027W	23 35 076 013	323	ZC0116	15 45 000 160	228	ZF5D82	15 25 743 208	109	ZM5171	15 44 101 800	185	ZQ5E44	15 25 733 121	117
S5269	23 05 113 600	316	SM7054	23 35 076 012	325	ZC0117	15 45 000 170	228	ZF5D83	15 25 743 401	109	ZM5172	15 44 102 400	184	ZQ5E51	15 25 733 280	117
S5271	23 05 021 000	313	V0120	17 04 012 000	72	ZC3000	15 47 300 000	209	ZF6D02	15 25 743 209	109	ZM5173	15 44 103 603	184	ZQ5E51.3	15 25 733 284	117
S5272	23 05 023 000	314	V0122	17 04 012 200	72	ZC3100	15 47 310 000	209	ZF6D03	15 25 743 402	109	ZM5191	15 39 087 300	187	ZQ5E53	15 25 733 473	117
S5273	23 05 021 100	313	V0123	17 04 012 300	71	ZD1124	15 40 110 613	211	ZF6D22	15 25 743 210	110	ZM5191	15 39 087 300	187	ZQ5E53.3	15 25 733 477	118
S5373	23 05 120 010	315	V0125	17 04 012 500	71	ZD1125	15 40 110 623	211	ZF6D23	15 25 743 403	110	ZM5192	15 39 087 450	187	ZQ5E54	15 25 733 122	118
S5374	23 05 120 020	315	V0219	17 04 021 900	72	ZD1134	15 40 111 214	212	ZF6D42	15 25 743 211	110	ZM5192	15 39 087 450	187	ZQ5E61	15 25 733 281	118
S5375	23 05 120 030	316	V94420	16 06 022 000	103	ZD1135	15 40 111 224	212	ZF6D43	15 25 743 404	110	ZM5233	15 39 087 121	190	ZQ5E61.3	15 25 733 285	118
S5376	23 05 120 040	316	Z52032	15 25 743 226	115	ZD1144	15 40 111 813	212	ZL1F22	15 25 731 246	135	ZM5243	15 39 087 211	190	ZQ5E63	15 25 733 474	119
S5378	23 05 032 010	314	Z53012	15 25 743 228	114	ZD1145	15 40 111 823	212	ZL1F42	15 25 731 247	135	ZM5253	15 39 087 281	190	ZQ5E63.3	15 25 733 478	119
S5381	23 05 130 000	316	Z55032	15 25 743 227	114	ZD1154	15 40 112 413	212	ZL1F43	15 25 731 444	136	ZM5333	15 39 087 122	190	ZQ5E64	15 25 733 123	119
S5381E	23 05 130 010	314	Z57032	15 25 743 224	114	ZD1155	15 40 112 423	213	ZL3F22	15 25 731 244	136	ZM5343	15 39 087 212	190	ZQ5E71	15 25 733 286	119
S5382	23 05 135 000	315	Z58032	15 25 743 225	115	ZD1223	15 40 130 670	213	ZL3F42	15 25 731 245	136	ZM5353	15 39 087 282	191	ZQ5E73	15 25 733 479	119
S5383	23 05 135 010	315	Z6911	15 24 115 010	141	ZD1233	15 40 131 270	213	ZL3F43	15 25 731 443	136	ZM5432	15 39 085 092	204	ZQ5E74	15 25 733 124	120
S5385	23 05 120 005	314	Z6913	15 24 014 013	140	ZD1243	15 40 131 870	213	ZL4206	15 25 653 206	118	ZM5442	15 39 085 182	204	ZQ5E81	15 25 733 287	120
S70200	23 33 170 021	321	Z73113	15 35 241 000	144	ZD1323	15 40 140 670	214	ZL4F22	15 25 743 201	136	ZM5452	15 39 085 242	204	ZQ5E83	15 25 733 480	120
S70201	23 33 170 022	321	Z73114	15 35 242 000	144	ZD1333	15 40 141 270	214	ZL5F42	15 25 733 296	133	ZM6123	15 39 087 071	191	ZQ5E84	15 25 733 125	120
S70202	23 33 170 023	322	Z73123	15 35 243 000	144	ZD1343	15 40 141 870	214	ZL5F43	15 25 733 299	133	ZM6125	15 39 085 071	191	ZQ5E91	15 25 743 215	120
S70203	23 33 170 010	321	Z73124	15 35 244 000	144	ZD1432	15 39 085 090	220	ZL5F42.6	15 25 743 200	133	ZM6133	15 39 087 123	191	ZQ5E93	15 25 743 408	121
S8130	23 08 201 550	309	Z73133	15 35 245 000	145	ZD1442	15 39 085 180	220	ZL5F43	15 25 733 492	134	ZM6135	15 39 085 121	191	ZQ6D11	15 25 733 272	122
S8131	23 08 201 510	307	Z73134	15 35 246 000	145	ZD1452	15 39 085 244	220	ZL5F43.3	15 25 733 495	134	ZM6143	15 39 087 213	192	ZQ6D13	15 25 733 465	122
S8230	23 08 203 550	309	Z73215	15 35 235 000	142	ZD2124	15 40 210 612	214	ZL5F43.6	15 25 733 496	134	ZM6145	15 39 085 211	192	ZQ6E21	15 25 733 291	122
S8231	23 08 203 510	308	Z73216	15 35 236 000	143	ZD2125	15 40 210 622	214	ZL5F52	15 25 743 229	134	ZM6153	15 39 087 283	192	ZQ6E21.3	15 25 733 292	122
S8250	23 08 205 050	309	Z73225	15 35 237 000	143	ZD2134	15 40 211 213	214	ZL5F53	15 25 743 411	134	ZM6155	15 39 085 281	192	ZQ6E23	15 25 733 484	122
S8251	23 08 205 010	308	Z73226	15 35 238 000	143	ZD2135	15 40 211 223	215	ZL5F62	15 25 743 230	135	ZM6233	15 39 087 124	192	ZQ6E23.3	15 25 733 485	123
S8253	23 08 305 050	310	Z73235	15 35 239 000	143	ZD2144	15 40 211 813	215	ZL5F63	15 25 743 412	135	ZM6243	15 39 087 214	193	ZQ6E24	15 25 733 126	123
S8270	23 08 207 550	309	Z73236	15 35 240 000	143	ZD2145	15 40 211 823	215	ZL6F22	15 25 743 202	135	ZM6253	15 39 087 284	193	ZQ6E41	15 25 733 293	123
S8271	23 08 207 510	308	Z73216	15 35 240 500	235	ZD2154	15 40 212 413	215	ZL8F02	15 25 730 234	137	ZM6333	15 39 087 125	193	ZQ6E43	15 25 733 486	123
S8273	23 08 307 550	310	Z73216	15 35 240 500	235	ZD2155	15 40 212 424	215	ZL8F03	15 25 730 429	137	ZM6343	15 39 087 215	193	ZQ6E44	15 25 733 127	123
S8280	23 08 210 050	309	Z7602B	15 38 155 000	234	ZD2223	15 40 230 670	216	ZL8F22	15 25 730 235	137	ZM6353	15 39 087 285	193	ZQ7E21	15 25 731 243	121
S8281	23 08 210 010	308	Z7602BL	15 38 157 000	234	ZD2233	15 40 231 270	216	ZL8F23	15 25 730 430	137	ZM6432	15 39 085 093	205	ZQ7E23	15 25 731 442	121
S8283	23 08 310 050	310	Z7602P	15 38 156 000	234	ZD2243	15 40 231 870	216	ZM1120	15 39 085 123	205	ZM6442	15 39 085 183	205	ZQ7E41	15 25 733 294	121
S8290	23 08 215 050	310	Z7602W	15 38 154 000	234	ZD2323	15 40 240 670	216	ZM1121	15 39 085 184	206	ZM6452	15 39 085 243	205	ZQ7E43	15 25 733 487	121
S8291	23 08 215 010	308	Z7609PW	15 38 169 000	235	ZD2333	15 40 241 270	216	ZM1222	15 39 085 245	206	ZM7153	15 39 087 150	195	ZQ7E50	15 25 730 221	131
S8293	23 08 315 050	310	Z7610	15 38 170 000	236	ZD2343	15 40 241 870	217	ZM1400	15 39 085 186	206	ZM7151	15 39 087 180	195	ZQ8155S	15 25 730 220	131
S8307	23 08 207 500	306	Z7615	15 38 176 000	233	ZD2432	15 39 085 091	221	ZM1401	15 39 085 220	207	ZM7152	15 39 087 320	196	ZQ8255S	15 25 730 416	132
S8310	23 08 210 000	307	Z7617	15 38 179 000	232	ZD2442	15 39 085 181	221	ZM1402	15 39 085 187	206	ZM7153	15 39 087 151	195	ZQ8255S.3	15 25 730 415	132
S8314	23 08 215 000	307	Z7618B	15 38 180 000	232	ZD2452	15 39 085 241	221	ZM1403	15 39 085 221	207	ZM7154	15 39 087 181	195	ZQ8338	15 25 730 423	129
S8324	23 08 225 000	307	Z7618W	15 38 181 000	232	ZD3121	15 40 115 510	210	ZM1404	15 39 085 188	207	ZM7155	15 39 087 321	196	ZQ8E12	15 25 730 229	128
S8405	23 08 325 000	307	Z7619B	15 38 182 000	233	ZD3122	15 40 115 570	210	ZM1405	15 39 085 222	207	ZM9000	15 90 900 001	208	ZQ8E12.3	15 25 730 233	129
S9121	23 09 010 010	296	Z7619W	15 38 183 000	233	ZD3221	15 40 125 510	211	ZM1406	15 39 085 189	207	ZM9000	15 90 900 002	208	ZQ8E13	15 25 730 424	129
S9122	23 09 010 020	297	Z7620B	15 38 184 000	233	ZD3222	15 40 125 570	211	ZM1407	15 39 085 223	208	ZM9001	15 90 900 002	208	ZQ8E14	15 25 730 114	130
S9123	23 09 010 030	298	Z7620W	15 38 185 000	233	ZE0101	15 27 000 800	141	ZM3010	15 39 722 000	202	ZM9001					

Order Code	Item Number	page	Order Code	Item Number	page
Z0Z516R	15 25 753 502	139	ZT1521E	15 46 138 401	150
Z0Z832R	15 25 750 500	112	ZT1531	15 46 138 500	151
Z0Z832R	15 25 750 500	140	ZT1621	15 46 138 600	151
ZR1433	15 44 104 032	173	ZT1621E	15 46 138 601	151
ZR1532	15 44 104 820	175	ZT1631	15 46 138 700	151
ZR1642	15 44 103 428	175	ZT3020	15 46 135 700	153
ZR1722	15 44 212 730	176	ZT3120	15 46 135 800	153
ZR2212	15 41 181 200	174	ZT3220	15 46 135 900	153
ZR5410	15 44 213 670	178	ZT4320	15 46 137 700	152
ZR9001	15 42 009 001	182	ZT4420	15 46 137 800	152
ZR9002	15 42 009 002	182	ZT4520	15 46 137 900	152
ZR9010	15 42 009 010	182	ZU083	15 46 138 000	148
ZR9011	15 42 009 011	182	ZU133	15 46 138 100	148
ZR9020	15 42 009 020	182	ZU166	15 46 138 200	148
ZR9021	15 42 009 021	182	ZU225	15 46 138 300	149
ZR9034	15 42 009 034	183	ZU310.12	15 46 139 200	146
ZR9035	15 42 009 035	183	ZU310.6	15 46 139 000	145
ZR9036	15 44 100 000	175	ZU310.9	15 46 139 100	146
ZR9036	15 44 100 000	183	ZU315.12	15 46 139 500	146
ZR9041	15 44 300 001	178	ZU315.6	15 46 139 300	146
ZR9041	15 44 300 001	183	ZU315.9	15 46 139 400	146
ZR9310	15 48 931 000	225	ZU320.12	15 46 139 800	147
ZS2110	15 31 211 010	229	ZU320.6	15 46 139 600	147
ZS2120	15 31 211 020	229	ZU320.9	15 46 139 700	147
ZS2130	15 31 211 030	229	ZU9001	15 46 009 001	149
ZS2140	15 31 211 040	230	ZU9002	15 46 009 002	149
ZS2213	15 31 221 300	165	ZU9003	15 46 009 003	149
ZS2221.2	15 31 222 120	170	ZU9004	15 46 009 004	150
ZS2223	15 31 222 300	165	ZU9005	15 46 009 005	150
ZS2231.2	15 31 223 120	170	ZU9902	15 46 009 902	149
ZS2233	15 31 223 300	165	ZV1112	15 40 110 621	217
ZS2243	15 31 224 300	166	ZV1122	15 40 110 820	217
ZS2313	15 31 231 300	166	ZV1132	15 40 111 120	217
ZS2323	15 31 232 300	166	ZV1142	15 40 111 520	218
ZS2333	15 31 233 300	166	ZV1152	15 40 112 220	218
ZS2343	15 31 234 300	166	ZV1160	15 40 116 500	219
ZS2413	15 31 241 300	155	ZV1161	15 40 146 500	219
ZS2423	15 31 242 300	155	ZV2112	15 40 210 621	218
ZS2433	15 31 243 300	156	ZV2122	15 40 210 820	218
ZS2443	15 31 244 300	156	ZV2132	15 40 211 120	218
ZS2443A	15 31 244 310	156	ZV2142	15 40 211 520	219
ZS2453	15 31 245 300	156	ZV2152	15 40 212 220	219
ZS2453A	15 31 245 310	156	ZZ1435T	15 60 014 350	183
ZS2463	15 31 246 300	157	ZZ2055T	15 60 020 550	183
ZS2463A	15 31 246 310	157	ZZ3070T	15 60 030 700	184
ZS2473	15 31 247 300	157	ZZ409BD	15 60 040 900	184
ZS2510	15 31 252 510	161			
ZS2511	15 31 242 511	163			
ZS2520	15 31 252 520	161			
ZS2521	15 31 242 521	163			
ZS2530	15 31 252 530	161			
ZS2531	15 31 242 531	163			
ZS2540	15 31 252 540	162			
ZS2541	15 31 242 541	163			
ZS2612	15 31 242 612	158			
ZS2622	15 31 242 622	158			
ZS2632	15 31 242 632	158			
ZS2642	15 31 242 642	159			
ZS2652	15 31 242 652	159			
ZS2662	15 31 242 662	159			
ZS2672	15 31 242 672	159			
ZS2712	15 31 242 712	159			
ZS2722	15 31 242 722	160			
ZS2732	15 31 242 732	160			
ZS2742	15 31 242 742	160			
ZS2812	15 31 281 200	170			
ZS2822	15 31 282 200	171			
ZS2832	15 31 283 200	171			
ZS2910	15 31 252 910	162			
ZS2911	15 31 242 911	164			
ZS2920	15 31 252 920	162			
ZS2921	15 31 242 921	164			
ZS2930	15 31 252 930	162			
ZS2931	15 31 242 931	164			
ZS2940	15 31 252 940	162			
ZS2941	15 31 242 941	164			
ZS3322	15 42 033 220	169			
ZS3332	15 42 033 320	169			
ZS3342	15 42 033 420	169			
ZS3360S	15 42 033 601	168			
ZS9010	15 31 900 010	167			
ZS9020	15 31 900 020	167			
ZS9030	15 31 900 030	167			
ZS9510	15 31 950 010	168			
ZT1040	15 46 138 800	151			
ZT1521	15 46 138 400	150			



Item Number	Order Code	page	Item Number	Order Code	page	Item Number	Order Code	page	Item Number	Order Code	page	Item Number	Order Code	page	Item Number	Order Code	page
10 11 102 000	B1110	36	10 32 224 201	B2629	53	13 26 023 205	B7332	60	14 51 701 200	P8502	76	15 25 730 429	ZL8F03	137	15 25 733 487	Z07E43	121
10 11 202 001	B11202	36	10 32 224 210	B25214	55	13 32 112 040	B7414	59	14 51 701 900	P8569	78	15 25 730 430	ZL8F23	137	15 25 733 492	ZL5F43	134
10 12 104 000	B12104	34	10 32 224 260	B25274	55	13 32 212 030	B7426	59	14 51 703 102	P8551P	79	15 25 731 110	Z03E24	128	15 25 733 495	ZL5F43.3	134
10 12 109 002	B1210F	34	10 32 226 200	B2620V	53	14 33 010 008	P2398	103	14 51 703 111	P8507	76	15 25 731 111	Z03E44	128	15 25 733 496	ZL5F43.6	134
10 12 114 000	B1211	34	10 32 226 212	B2521V	55	14 33 010 009	P2399	103	14 51 703 200	P8506	75	15 25 731 112	Z01E24	125	15 25 733 497	ZF5023	107
10 12 204 000	B1220	33	10 32 226 260	B2527V	56	14 39 011 900	P4710	102	14 51 703 300	P8504	76	15 25 731 113	Z01E44	125	15 25 733 498	ZF5043	108
10 12 209 002	B1220F	34	10 32 322 301	B2533	56	14 39 013 900	P4711	102	14 51 703 402	P8508	76	15 25 731 208	Z09140	140	15 25 733 499	ZF5053	108
10 12 214 000	B1221	34	10 32 422 300	B2543	56	14 39 013 901	P4712	102	14 51 703 500	P8555	79	15 25 731 226	Z03D11	126	15 25 736 211	Z091250	132
10 12 302 000	B1230	35	10 32 521 021	B2552	56	14 40 004 901	P4535	91	14 51 704 100	P8511	75	15 25 731 230	Z01D11	124	15 25 736 411	Z092250	133
10 12 312 000	B1231	35	10 33 224 170	B24294	56	14 40 004 902	P3311	96	14 51 704 101	P8572	79	15 25 731 236	Z03E21	127	15 25 743 200	ZL5F42.6	133
10 12 402 000	B1240	35	10 33 224 170	B24294	56	14 40 004 904	P3210	85	14 51 704 200	P8582	80	15 25 731 237	Z03E21.3	127	15 25 743 201	ZL4F22	136
10 12 412 000	B1241	35	10 41 007 601	B13763	49	14 40 004 907	P3213	86	14 51 704 300	P8583	80	15 25 731 238	Z03E41	128	15 25 743 202	ZL4F22	136
10 12 501 000	B1250	35	10 41 007 611	B13762	47	14 40 011 100	P3150	82	14 51 704 400	P8584	80	15 25 731 240	Z01E21	124	15 25 743 203	ZF5022	107
10 12 511 000	B1251	36	10 41 007 615	B1376	48	14 40 011 203	P3160	82	14 51 704 600	P8571	79	15 25 731 241	Z01E21.3	124	15 25 743 204	ZF5042	107
10 12 601 000	B1260	36	10 41 018 611	B13861	48	14 40 011 500	P3116	82	14 51 705 300	P8573	80	15 25 731 242	Z01E41	125	15 25 743 205	ZF5052	108
10 13 101 201	B0114T	30	10 41 018 910	B1389	48	14 40 012 111	P3113	83	14 51 705 400	P8574	80	15 25 731 243	Z07E21	121	15 25 743 206	ZF5062	108
10 13 102 002	B01102	29	10 41 018 911	B13892	48	14 40 013 114	P4702	84	14 51 710 500	P8105	77	15 25 731 244	ZL3F22	136	15 25 743 207	ZF5042.2	108
10 13 121 001	B01116	29	10 41 019 205	B13925	49	14 40 013 115	P4703	100	14 51 710 700	P8107	77	15 25 731 245	ZL3F42	136	15 25 743 208	ZF5082	109
10 13 122 000	B03112	24	10 41 019 211	B13921	48	14 40 013 116	P4706	100	14 54 007 100	G1110	236	15 25 731 246	ZL1F22	135	15 25 743 209	ZF6003	109
10 13 122 001	B0110L	30	10 41 062 511	B1325	49	14 40 013 123	P3170	81	14 54 007 200	G1120	236	15 25 731 247	ZL1F42	135	15 25 743 210	ZF6022	110
10 13 124 000	B03114	24	10 42 102 511	B15101	39	14 40 013 124	P3380	97	14 54 007 250	G1125	236	15 25 731 248	ZF3D02	112	15 25 743 211	ZF6042	110
10 13 124 100	B02114	26	10 42 103 011	B15711	39	14 40 013 125	P3114	83	14 54 008 100	G1130	237	15 25 731 249	ZF3D22	112	15 25 743 212	ZF2D52	113
10 13 124 200	B01114	29	10 42 121 611	B15651	39	14 40 014 100	P3115	82	14 54 009 200	G1150	237	15 25 731 250	ZF3D42	112	15 25 743 213	ZF2D62	113
10 13 126 000	B0211V	27	10 42 122 011	B15201	39	14 40 022 200	P3112	83	14 54 010 100	G1160	237	15 25 731 251	ZF1D02	110	15 25 743 214	ZF2D82	114
10 13 128 000	B01118	29	10 42 122 015	B1520	40	14 40 032 202	P3861	85	14 54 012 100	G1180	237	15 25 731 252	ZF1D22	111	15 25 743 215	Z05E91	114
10 13 128 100	B02118	27	10 42 122 511	B15221	40	14 40 032 400	P3862	85	14 54 013 100	G1190	238	15 25 731 253	ZF1D42	111	15 25 743 216	Z05E92	114
10 13 201 201	B0124T	31	10 42 161 611	B15601	40	14 40 033 100	P3819	96	14 54 014 100	G1210	238	15 25 731 407	Z09141	141	15 25 743 217	Z05E93	114
10 13 202 002	B01202	30	10 42 162 011	B15701	40	14 40 093 109	P3846A	100	14 54 015 100	G1240	237	15 25 731 425	Z03D13	127	15 25 743 218	Z05E93	114
10 13 221 001	B01216	31	10 42 162 015	B1570	40	14 40 113 100	P4715	101	14 56 000 060	P3306	97	15 25 731 429	Z01D13	124	15 25 743 219	Z05E93	114
10 13 222 000	B03212	25	10 42 163 221	B15951	41	14 40 211 100	P3400	85	14 56 000 100	P3313	97	15 25 731 435	Z03E23	127	15 25 743 220	Z05E93	114
10 13 222 001	B0120L	31	10 42 201 611	B15161	41	14 40 812 900	P3887	101	14 56 000 110	P3314	97	15 25 731 436	Z03E23.3	127	15 25 743 221	ZL5F52	134
10 13 224 000	B03214	25	10 42 201 612	B15163	41	14 40 812 903	P4713	101	14 56 000 120	P3315	98	15 25 731 437	Z03E43	128	15 25 743 222	ZL5F62	135
10 13 224 100	B02214	27	10 42 201 615	B1516	41	14 40 813 100	P3888	93	14 56 000 130	P3316	98	15 25 731 439	Z03E43	128	15 25 743 223	ZL5F62	135
10 13 224 200	B01214	30	10 42 202 511	B15251	41	14 40 813 110	P3894	84	14 56 000 140	P3317	98	15 25 731 440	Z01E23.3	125	15 25 743 224	ZL5F62	135
10 13 226 000	B0221V	27	10 42 202 512	B15253	42	14 40 813 130	P3897	100	14 56 000 150	P3318	98	15 25 731 441	Z01E43	125	15 25 743 225	ZF5083	109
10 13 228 000	B01218	30	10 42 202 514	B15254	45	14 40 813 150	P4704	83	14 56 000 160	P3319	98	15 25 731 442	Z07E23	121	15 25 743 226	ZF6003	109
10 13 228 100	B02218	28	10 42 202 515	B1525	42	14 40 813 160	P4705	100	14 56 000 170	P3320	99	15 25 731 443	ZL3F43	136	15 25 743 227	ZF6023	110
10 13 302 001	B01302	31	10 42 203 211	B15322	42	14 40 813 170	P3111	83	15 20 503 500	Z0W514R	130	15 25 731 444	ZL1F43	136	15 25 743 228	ZF6043	110
10 13 304 001	B01304	31	10 42 203 212	B15323	42	14 40 813 170	P3111	83	15 20 503 501	Z0W514R	138	15 25 731 445	ZF3D03	112	15 25 743 229	ZF2D63	113
10 13 322 000	B03312	25	10 42 203 214	B15324	45	14 40 833 100	P3889	99	15 20 503 501	Z0W515R	138	15 25 731 446	ZF3D03	112	15 25 743 230	ZF2D63	113
10 13 322 100	B02312	28	10 42 203 215	B1532	42	14 40 833 200	P4112	92	15 20 503 501	Z0W515R	138	15 25 731 447	ZF3D43	113	15 25 743 231	Z05E93	114
10 13 322 200	B01312	32	10 42 232 011	B15451	43	14 40 883 200	P3310K	96	15 20 503 502	Z0W516R	138	15 25 731 448	ZF1D03	111	15 25 743 232	ZL5F53	134
10 13 400 001	B01402	32	10 42 232 511	B15431	43	14 41 162 100	P3521	88	15 20 503 502	Z0W516R	138	15 25 731 449	ZF1D33	111	15 25 743 233	ZL5F63	135
10 13 404 001	B01404	32	10 42 233 011	B15441	43	14 41 203 100	P3528	87	15 24 014 013	Z6913	140	15 25 731 450	ZF1D43	111	15 25 750 500	Z02832R	12
10 13 422 000	B03412	26	10 42 235 411	B15231	43	14 41 212 901	P3540	88	15 24 115 010	Z6911	141	15 25 733 121	Z05E44	117	15 25 750 500	Z02832R	12
10 13 422 100	B02412	28	10 42 243 011	B15301	43	14 41 233 110	P3531	87	15 25 283 273	ZF5147	104	15 25 733 122	Z05E54	118	15 25 751 500	Z03322R	140
10 13 422 200	B01412	32	10 42 243 015	B1530	44	14 41 233 120	P3532	87	15 25 283 274	ZF5147.3	104	15 25 733 123	Z05E64	119	15 25 751 500	Z03322R	139
10 13 501 001	B01501	32	10 42 245 011	B15851	44	14 41 250 920	P3534	86	15 25 283 275	ZF5157	105	15 25 733 124	Z05E74	120	15 25 753 500	Z02514R	11
10 13 521 000	B03511	26	10 42 245 015	B1585	44	14 41 251 900	P3535	86	15 25 283 276	ZF5157.3	105	15 25 733 125	Z05E84	120	15 25 753 500	Z02514R	11
10 13 521 100	B02511	28	10 42 247 711	B15771	44	14 41 265 110	P3536	87	15 25 283 277	ZF51540	106	15 25 733 126	Z06E24	123	15 25 753 501	Z02515R	11
10 13 521 200	B01511	33	10 42 303 211	B15331	44	14 41 273 110	P3537	88	15 25 283 278	ZF51640	107	15 25 733 127	Z06E44	123	15 25 753 501	Z02515R	11
10 13 800 000	B0125T	33	10 43 036 721	B3357F1	49	14 41 283 110	P3538	99	15 25 283 279	ZF5167	106	15 25 733 127	Z06E44	123	15 25 753 502	Z02516R	11
10 14 122 000	B02112	26	10 43 036 431	B3364F1	50	14 41 292 150	P3541	86	15 25 283 410	ZF5148	105	15 25 733 128	Z06D11	122	15 25 753 502	Z02516R	11
10 14 222 000	B02212	27	10 43 037 721	B3377F1	50	14 41 317 000	P3542	88	15 25 283 411	ZF5148.3	105	15 25 733 129	Z06E21	115	15 27 000 800	ZE0101	141
10 17 101 000	B03146	25	10 43 038 921	B3389F1	50	14 41 341 100	P3539	87	15 25 283 412	ZF5158	105	15 25 733 128	Z06E31	116	15 27 001 200	ZE0102	142
10 17 201 000	B03246	25	10 43 039 221	B3392F1	50	14 46 002 000	P3920	95	15 25 283 413	ZF5158.3	106	15 25 733 129	Z06E41				



Item Number	Order Code	page	Item Number	Order Code	page	Item Number	Order Code	page	Item Number	Order Code	page	Item Number	Order Code	page	Item Number	Order Code	page
15 31 242 742	ZS2742	160	15 39 082 150	ZM4321	197	15 40 110 820	ZV1122	217	15 44 212 730	ZR1722	176	15 90 900 001	ZM9000	196	18 21 100 200	K0202	301
15 31 242 911	ZS2911	164	15 39 082 151	ZM4323	198	15 40 111 120	ZV1132	217	15 44 213 670	ZR5410	178	15 90 900 001	ZM9000	208	18 21 100 300	K0311	302
15 31 242 921	ZS2921	164	15 39 082 240	ZM4322	198	15 40 111 214	ZD1134	212	15 44 300 001	ZR9041	178	15 90 900 002	ZM9001	196	18 21 100 301	K0312	302
15 31 242 931	ZS2931	164	15 39 082 241	ZM4324	199	15 40 111 224	ZD1135	212	15 44 300 001	ZR9041	183	15 90 900 002	ZM9001	208	19 01 012 016	P01320R	261
15 31 242 941	ZS2941	164	15 39 084 002	ZM5165	185	15 40 111 520	ZV1142	218	15 45 000 050	ZC0105	227	16 03 026 000	N9221	67	19 02 010 200	P02100	261
15 31 243 300	ZS2433	156	15 39 084 003	ZM5166	185	15 40 111 813	ZD1144	212	15 45 000 060	ZC0106	227	16 03 027 000	N9321	67	19 02 020 150	P0221U	267
15 31 244 300	ZS2443	156	15 39 085 050	ZM3405	194	15 40 111 823	ZD1145	212	15 45 000 080	ZC0108	226	16 03 028 000	N9331	67	19 02 330 154	P1321PD	267
15 31 244 310	ZS2443A	156	15 39 085 070	ZM5125	188	15 40 112 220	ZV1152	218	15 45 000 090	ZC0109	226	16 03 029 000	N9341	68	19 04 030 000	P0003C	281
15 31 245 300	ZS2453	156	15 39 085 071	ZM6125	191	15 40 112 413	ZD1154	212	15 45 000 100	ZC0110	226	16 03 030 000	N9361	68	19 04 040 000	P0004C	281
15 31 245 310	ZS2453A	156	15 39 085 080	ZM3406	194	15 40 112 423	ZD1155	213	15 45 000 110	ZC0111	227	16 04 821 110	B51214	65	19 05 010 003	P0072	282
15 31 246 300	ZS2463	157	15 39 085 090	ZD1432	220	15 40 115 510	ZD3121	210	15 45 000 140	ZC0114	228	16 04 822 110	B50224	66	19 05 011 001	P0068	285
15 31 246 310	ZS2463A	157	15 39 085 091	ZD2432	221	15 40 115 570	ZD3122	210	15 45 000 160	ZC0116	228	16 04 844 100	B50449	66	19 05 120 010	P0063	283
15 31 247 300	ZS2473	157	15 39 085 092	ZM5432	204	15 40 116 500	ZV1160	219	15 45 000 170	ZC0117	228	16 04 844 110	B50444	66	19 05 120 030	P0069	286
15 31 252 510	ZS2510	161	15 39 085 093	ZM6432	205	15 40 125 510	ZD3221	210	15 46 009 001	ZU9001	149	16 04 845 110	B53450	65	19 06 010 501	A6001.1	372
15 31 252 520	ZS2520	161	15 39 085 110	ZM3407	194	15 40 125 570	ZD3222	211	15 46 009 002	ZU9002	149	16 04 845 111	B53455	65	19 06 010 504	A6002.0	373
15 31 252 530	ZS2530	161	15 39 085 120	ZM5135	189	15 40 130 670	ZD1223	213	15 46 009 003	ZU9003	149	16 04 845 112	B53457	65	19 06 010 507	A6000.3	372
15 31 252 540	ZS2540	162	15 39 085 121	ZM6135	191	15 40 131 270	ZD1233	213	15 46 009 004	ZU9004	150	16 04 845 210	B50457	66	19 06 010 510	A6002.2	373
15 31 252 910	ZS2910	162	15 39 085 122	ZM3408	194	15 40 131 870	ZD1243	213	15 46 009 005	ZU9005	150	16 04 846 114	B50460	66	19 06 010 512	A6000.5	372
15 31 252 920	ZS2920	162	15 39 085 123	ZM1120	205	15 40 140 670	ZD1323	213	15 46 009 902	ZU9902	149	16 04 849 120	B56499	64	19 06 100 050	P0039	282
15 31 252 930	ZS2930	162	15 39 085 150	ZM4328	199	15 40 141 270	ZD1333	214	15 46 135 700	ZT3020	153	16 04 882 110	B50029	67	19 06 100 060	P0050	282
15 31 252 940	ZS2940	162	15 39 085 180	ZD1442	220	15 40 141 870	ZD1343	214	15 46 135 800	ZT3120	153	16 06 022 000	V94420	103	19 06 100 090	P0066	282
15 31 281 200	ZS2812	170	15 39 085 181	ZD2442	221	15 40 146 500	ZV1161	219	15 46 135 900	ZT3220	153	16 06 025 000	N1014	73	19 06 110 200	P0034	282
15 31 282 200	ZS2822	171	15 39 085 182	ZM4442	204	15 40 210 612	ZD2124	214	15 46 137 700	ZT4320	152	16 08 000 001	N1015	74	19 06 110 300	P0038	282
15 31 283 200	ZS2832	171	15 39 085 183	ZM6442	205	15 40 210 621	ZV2112	218	15 46 137 800	ZT4420	152	16 11 630 500	B63058	68	19 06 200 100	A6100.0	371
15 31 900 010	ZS9010	167	15 39 085 184	ZM1121	206	15 40 210 622	ZD2125	214	15 46 137 900	ZT4520	152	16 11 631 000	B63106	69	19 06 200 101	A6100.1	371
15 31 900 020	ZS9020	167	15 39 085 186	ZM1400	206	15 40 210 820	ZV2122	218	15 46 138 000	ZU083	148	16 11 631 001	B63108L	69	19 06 200 102	A6100.2	371
15 31 900 030	ZS9030	167	15 39 085 187	ZM1402	206	15 40 211 120	ZV2132	218	15 46 138 100	ZU133	148	16 11 631 002	B6310BE	69	19 06 200 103	A6100.3	372
15 31 950 010	ZS9510	168	15 39 085 188	ZM1404	207	15 40 211 213	ZD2134	214	15 46 138 200	ZU166	148	16 11 632 000	B63206Y	69	19 06 200 104	A6100.4	371
15 35 235 000	ZT3215	142	15 39 085 189	ZM1406	207	15 40 211 223	ZD2135	215	15 46 138 300	ZU225	149	16 13 052 600	B05268	71	19 06 200 105	A6100.5	373
15 35 236 000	ZT3216	143	15 39 085 210	ZM5145	189	15 40 211 520	ZV2142	219	15 46 138 400	ZT1521	150	16 13 052 700	B05278	71	19 06 200 106	A6100.6	373
15 35 237 000	ZT3225	143	15 39 085 211	ZM6145	192	15 40 211 813	ZD2144	215	15 46 138 401	ZT1521E	150	16 13 053 100	B05318	70	19 06 200 107	A6100.7	373
15 35 238 000	ZT3226	143	15 39 085 220	ZM1401	207	15 40 211 823	ZD2145	215	15 46 138 500	ZT1531	151	16 13 053 200	B05328	70	19 06 200 108	A6100.8	373
15 35 239 000	ZT3235	143	15 39 085 221	ZM1403	207	15 40 212 220	ZV2152	219	15 46 138 600	ZT1621	151	16 13 054 300	B05438	70	19 06 200 109	A6100.9	373
15 35 240 000	ZT3236	143	15 39 085 222	ZM1405	207	15 40 212 413	ZD2154	215	15 46 138 601	ZT1621E	151	16 13 054 500	B05458	70	19 06 300 100	A6004.2	372
15 35 241 000	ZT3113	144	15 39 085 223	ZM1407	208	15 40 212 424	ZD2155	215	15 46 138 700	ZT1631	151	17 02 010 034	J58133	339	19 06 300 101	A6004.1	372
15 35 242 000	ZT3114	144	15 39 085 240	ZM4329	199	15 40 230 670	ZD2223	216	15 46 138 800	ZT1040	151	17 02 010 035	J5810	339	19 06 300 102	A6004.0	372
15 35 243 000	ZT3123	144	15 39 085 241	ZD2452	221	15 40 231 270	ZD2233	216	15 46 139 000	ZU310.6	145	17 03 060 021	N3110	73	19 06 300 103	A6003.0	372
15 35 244 000	ZT3124	144	15 39 085 242	ZM5452	204	15 40 231 870	ZD2243	216	15 46 139 100	ZU310.9	146	17 03 100 021	N3111	73	19 06 300 104	A6004.3	372
15 35 245 000	ZT3133	145	15 39 085 243	ZM6452	205	15 40 240 670	ZD2323	216	15 46 139 200	ZU310.12	146	17 03 150 021	N3112	73	19 06 300 105	A6004.4	372
15 35 246 000	ZT3134	145	15 39 085 244	ZD1452	220	15 40 241 270	ZD2333	216	15 46 139 300	ZU315.6	146	17 03 225 021	N3113	72	19 06 300 106	A6004.7	374
15 36 000 000	Z00303	154	15 39 085 245	ZM1122	206	15 40 241 870	ZD2343	217	15 46 139 400	ZU315.9	146	17 04 012 000	V0120	72	19 06 300 107	A6004.6	373
15 36 020 000	Z00304	154	15 39 085 280	ZM5155	189	15 41 181 200	ZR2121	182	15 46 139 500	ZU315.12	146	17 04 012 020	V0122	72	19 06 300 108	A6004.5	373
15 36 020 001	Z00504	154	15 39 085 281	ZM6155	192	15 42 009 001	ZR9001	182	15 46 139 600	ZU320.6	147	17 04 012 030	V0123	71	19 06 300 109	A6003.1	373
15 36 020 002	Z00704	155	15 39 085 360	ZM4325	198	15 42 009 002	ZR9002	182	15 46 139 700	ZU320.9	147	17 04 012 050	V0125	71	19 06 300 110	A6004.8	374
15 38 150 200	ZT599B	235	15 39 087 000	ZM5167	185	15 42 009 011	ZR9010	182	15 46 139 800	ZU320.12	147	17 04 021 900	V0219	72	19 06 300 111	A6004.9	374
15 38 150 201	ZT599W	234	15 39 087 070	ZM5123	188	15 42 009 012	ZR9011	182	15 47 300 000	ZC3000	209	18 04 000 100	K1731	303	19 09 040 200	P54212	273
15 38 154 000	ZT602W	234	15 39 087 071	ZM6123	191	15 42 009 020	ZR9020	182	15 47 310 000	ZC3100	209	18 04 000 300	K1821	303	19 09 040 203	P54222	273
15 38 155 000	ZT602B	234	15 39 087 120	ZM5133	188	15 42 009 021	ZR9021	182	15 48 111 000	ZN1110	223	18 04 000 500	K1851	303	19 09 480 301	P54252	273
15 38 156 000	ZT602P	234	15 39 087 121	ZM5233	190	15 42 009 034	ZR9034	183	15 48 111 100	ZN1111	223	18 04 000 600	K1731.2	305	19 10 000 800	P0055M	284
15 38 157 000	ZT602BL	234	15 39 087 122	ZM6133	190	15 42 009 035	ZR9035	183	15 48 111 200	ZN1112	223	18 04 000 601	K1821.2	305	19 10 000 900	P0056M	284
15 38 169 000	ZT609W	235	15 39 087 123	ZM6133	191	15 42 033 220	ZS3322	169	15 48 121 000	ZN1210	222	18 04 000 602	K1851.2	305	19 14 071 100	PM0902	274
15 38 170 000	ZT610	236	15 39 087 124	ZM6233	192	15 42 033 320	ZS3332	169	15 48 121 100	ZN1211	222	18 04 100 100	K1331	303	19 14 071 200	PM0904	274
15 38 176 000	ZT615	236	15 39 087 125	ZM6333	193	15 42 033 420	ZS3342	169	15 48 131 000	ZN1310	224	18 04 100 300	K1411	303	19 14 071 250	PM0905	274
15 38 179 000	ZT617	232	15 39 087 150	ZM7150	195	15 42 033 601	ZS3360S	168	15 48 131 100	ZN1311	224	18 04 100 500	K1451	303	19 14 081 102	PM1102	274
15 38 180 000	ZT618B	232	15 39 087 151	ZM7153	195	15 43 081 000	ZALL	171	15 48 931 000	ZR9310	225	18 04 100 700	K1331.				





Item Number	Order Code	page	Item Number	Order Code	page	Item Number	Order Code	page	Item Number	Order Code	page	Item Number	Order Code	page	Item Number	Order Code	page
19 22 040 191	P04219G	267	19 28 732 000	P08620W	276	21 04 104 000	P56000S	370	23 09 010 090	S9129	297	24 13 150 232	S18315	295	26 06 169 000	E5080	244
19 22 040 302	P0423R	263	19 28 733 300	P19733	275	21 04 105 000	P56400S	370	23 09 010 100	S9130	299	24 13 220 132	S14322	294	26 06 170 000	E5111	244
19 22 040 400	P0422	267	19 28 742 500	P08625W	276	21 04 105 000	P56400S	370	23 09 010 120	S9134	296	24 13 220 232	S18322	295	26 06 172 000	E8647	245
19 22 040 500	P0425R	263	19 28 745 000	P08650W	276	21 05 564 000	P56400S	370	23 09 020 010	S9131	299	24 13 230 132	S14323	294	26 06 174 000	E6670	245
19 22 050 150	P0521	266	19 31 000 020	P5822	286	21 05 564 000	P56400S	369	23 09 020 020	S9132	299	24 13 230 232	S18323	295	26 06 176 000	E0387	245
19 22 050 153	P0521R	263	19 36 055 310	P5531	16	21 06 000 100	P5660FR	366	23 09 110 010	S9221	297	24 13 250 132	S14325	294	26 06 177 000	E8010	246
19 22 050 201	P0522	267	19 36 055 310	P5531	286	22 01 001 000	M0018	361	23 09 110 020	S9222	297	24 13 250 232	S18325	295	26 17 000 500	EV026	252
19 22 050 300	P0523R	263	19 36 055 320	P5532	16	22 01 002 000	M0048	361	23 09 120 010	S9230	299	24 13 720 132	S14372	293	26 17 001 200	EV012	252
19 22 050 508	P0525R	264	19 36 055 320	P5532	287	22 01 012 000	M0014A	360	23 09 130 010	S9310	300	24 13 720 232	S18372	294	26 17 001 400	EV014	251
19 22 060 151	P0621	268	19 36 553 300	P5533	16	22 01 013 000	M0071	360	23 09 130 020	S9320	300	24 13 730 132	S14373	293	26 17 001 401	EV014B	251
19 22 060 200	P0622	266	19 36 553 300	P5533	287	22 01 014 000	M0012A	360	23 15 094 010	S9401	327	24 13 730 232	S18373	294	26 17 001 600	EV016	251
19 22 060 302	P0623R	264	19 36 553 400	P5534	17	22 01 015 000	M0003B	361	23 15 094 020	S9402	327	24 13 750 132	S14375	294	26 17 002 000	EV020	252
19 22 060 502	P0625R	264	19 36 553 400	P5534	287	22 02 003 000	M2092	358	23 15 094 030	S9403	327	24 17 715 202	S11370	295	26 17 002 200	EV022	252
19 22 120 200	P0222C0	268	19 50 011 201	A1399	374	22 02 007 000	M0391	358	23 15 094 040	S9404	327	24 21 130 212	S03030	289	26 17 002 300	EV023	252
19 22 130 150	P1321	266	19 50 011 202	A1398.2	374	22 02 008 000	M0420	357	23 33 001 010	SL0101	318	24 21 130 213	S03030N	289	26 17 002 500	EV025	251
19 22 130 156	P1321R	264	19 50 011 203	A1398.3	375	22 02 013 000	M0400	359	23 33 003 010	SL0301	318	24 21 130 214	S03031N	289	26 17 002 600	EV029	253
19 22 130 200	P1322	266	19 50 011 204	A1398.4	375	22 02 014 000	M0320	358	23 33 020 010	SL2001	318	24 21 150 212	S03050	289	26 17 002 800	EV028	253
19 22 130 308	P1323R	264	19 50 011 207	A1396.2	375	22 02 015 000	M0305	359	23 33 101 011	S10100	319	24 21 150 213	S03050N	290	26 17 010 400	EV104	254
19 22 130 508	P1325R	264	20 01 151 010	F61511	382	22 02 016 000	M3691	357	23 33 101 013	S10102	319	24 21 230 230	S03330	289	26 17 010 500	EV105	254
19 22 140 152	P1421R	264	20 01 151 020	F61512	383	22 02 017 000	M3620	358	23 33 101 014	S10103	319	24 21 250 230	S03350	289	26 17 010 600	EV106	254
19 22 140 153	P1421	268	20 01 151 030	F61513	383	22 02 019 000	M0430	357	23 33 101 015	S10110	319	24 25 130 210	S03130N	291	26 17 010 902	EV112	253
19 22 140 200	P1422	266	20 01 151 040	F61514	383	22 02 020 000	M0230	358	23 33 101 016	S10101	319	24 25 130 220	S03130	290	26 17 010 902	EV112	253
19 22 140 302	P14231	262	20 01 151 050	F61515	383	22 02 021 000	M3216	359	23 33 101 031	S10300	319	24 25 150 210	S03150N	291	26 18 002 600	E0086	256
19 22 140 303	P1423R	264	20 01 151 060	F61516	383	22 03 003 000	N0322	361	23 33 101 032	S10310	319	24 25 150 220	S03150	290	26 27 303 000	E30300	22
19 22 140 503	P1425R	264	20 01 151 070	F61517	384	22 05 000 010	M0007A	360	23 33 101 051	S10500	319	24 25 210 210	S03210N	291	26 27 303 000	E30300	255
19 22 150 154	P1521R	264	20 01 151 090	F61519	384	22 06 000 010	M0501	362	24 25 230 210	S10510	320	24 25 230 210	S03230N	291	26 93 000 120	E05018	249
19 22 150 155	P1521	268	20 01 151 092	F61592	384	22 06 000 020	M0502	362	23 33 101 070	S10000	320	24 25 230 220	S03230	290	26 93 000 160	E08400	250
19 22 150 200	P1522	267	20 01 191 020	F61912	382	22 06 000 030	M0503	362	23 33 101 100	S11000	320	24 25 250 210	S03250N	291	26 93 000 180	E03070	250
19 22 150 304	P1523R	265	20 01 192 010	F61921	384	23 04 000 101	S4001N	359	23 33 130 051	S30500	320	24 25 250 220	S03250	290	26 93 000 220	E06018	250
19 22 150 305	P1523PD	268	20 01 192 020	F61922	384	23 04 000 300	S4003	359	23 33 130 052	S30510	320	24 25 430 230	S03430	290	26 93 000 230	E06016	250
19 22 150 306	P1523CU	268	20 01 192 030	F61923	385	23 05 021 000	S5271	313	23 33 130 101	S31000	320	24 25 450 230	S03450	290	26 93 000 240	E0387	250
19 22 150 308	P1523R	265	20 01 192 040	F61924	385	23 05 021 100	S5273	313	23 33 130 120	S31010	320	24 35 724 032	S00003	291	27 02 029 000	J0685	320
19 22 160 152	P1621R	265	20 01 192 050	F61925	385	23 05 023 000	S5272	314	23 33 130 121	S31010	320	25 01 000 100	J0200	334	27 02 031 000	J0701	328
19 22 160 153	P1621	268	20 01 192 060	F61926	385	23 05 032 010	S5378	316	23 33 130 122	S30110	320	25 01 000 200	J0203	335	27 02 033 000	J0703	328
19 22 160 155	P1621	267	20 01 192 070	F61927	385	23 05 050 200	S5131	313	23 33 130 150	S83015	317	25 01 000 300	J0240	334	27 02 034 000	J0704	329
19 22 160 200	P1622	268	20 01 192 090	F61929	386	23 05 050 201	S5231S	313	23 33 130 151	S31510	320	25 01 000 330	J0240E	334	27 02 035 000	J0705	329
19 22 160 302	P1623R	265	20 01 192 099	F61999	386	23 05 058 401	S5213	311	23 33 130 152	S31510	321	25 01 000 400	J0260	334	27 02 038 000	J0708	329
19 22 160 502	P1625R	265	20 01 251 020	F62512	382	23 05 059 009	S5194	316	23 33 130 250	S30200	321	25 01 100 100	J0220A	335	27 02 039 000	J0709	329
19 22 330 150	PC1321	267	20 02 151 520	F6515	387	23 05 100 200	S5141	312	23 33 130 251	S30210	321	25 01 100 300	J0222	335	27 03 105 000	J0665	332
19 22 330 152	PC1321R	265	20 02 191 020	F6910	387	23 05 100 201	S5241S	313	23 33 130 350	S30300	321	25 03 000 100	J0197	336	27 03 106 000	J0666	332
19 22 340 151	PC1421R	265	20 02 502 002	F6030	388	23 05 113 000	S5261	311	23 33 130 351	S30310	321	25 03 000 400	J0198	336	27 04 030 000	J0680	332
19 22 340 301	PC1423R	265	20 03 191 020	F51912	388	23 05 113 002	S5262	312	23 33 130 750	S30700	321	25 04 200 100	J0199	336	27 04 039 000	J0690	332
19 22 340 501	P14251	262	20 03 250 320	F52503	388	23 05 113 003	S5268	312	23 33 130 751	S31010	321	25 04 500 110	J0669	332	27 04 280 010	J0669	332
19 22 340 502	PC1425R	265	20 03 250 520	F52502	388	23 05 113 500	S5265	312	23 33 131 030	S83103	317	25 04 600 110	J0103	337	27 04 310 000	J0801	330
19 22 341 000	P14201	266	20 04 752 500	F87525	388	23 05 113 502	S5266	312	23 33 131 100	S83110	317	25 04 700 110	J0104	337	27 04 320 000	J0802	330
19 22 350 151	PC1521R	262	20 05 000 010	F6070	389	23 05 113 600	S5269	316	23 33 131 150	S83115	317	25 06 000 800	J0400	338	27 04 330 000	J0803	330
19 22 360 150	PC1621R	266	20 05 060 900	F6090	387	23 05 120 005	S5385	314	23 33 170 010	S70203	321	25 07 100 600	J5802	337	27 04 340 000	J0804	331
19 22 570 150	PS1721	267	20 05 061 000	F6100	386	23 05 120 010	S5373	315	23 33 170 021	S70200	321	25 07 100 700	J5803	338	27 04 350 000	J0806	331
19 23 030 000	P0320	272	20 05 061 100	F6110	386	23 05 120 020	S5374	315	23 33 170 022	S70201	321	25 08 000 810	J5709	338	27 04 560 000	J0906	331
19 23 030 000	P0320	272	20 05 062 000	F6200	387	23 05 120 030	S5375	316	23 33 170 023	S70202	321	25 08 000 900	J5710	338	27 04 570 000	J0907	331
19 23 130 000	P1320	272	20 05 063 000	F6300	387	23 05 120 040	S5376	316	23 34 130 100	SD3010	318	25 08 100 100	J5711	338	28 04 000 013	C0024	346
19 23 150 000	P1520	272	20 06 000 000	F6060	389	23 05 130 000	S5381	314	23 35 050 010	SM5001	324	25 08 100 200	J5712	339	28 04 000 014	C0025	346
19 25 030 020	P00242	283	20 06 000 010	F6080	389	23 05 130 010	S5381E	314	23 35 050 020	SM5102	324	25 12 000 100	J0401	302	28 04 000 030	C0030	346
19 25 030 030	P00252	283	21 01 103 000	P5681	365	23 05 135 000	S5382	315	23 35 050 030	SM5003	325	25 20 236 400	J6014	333	30 10 000 291	H1085	344
19 25 030 040	P00262	283	21 01 104 000	P5682	365	23 05 135 010	S5383	315	23 35 050 050	SM5105	325	25 20 900 088	J50988	333	30 10 000 292	H1086	344
19 25 030 050	P00272	283	21 01 106 000														



Item Number	Order Code	page	Item Number	Order Code	page
30 24 040 630	H4063	6	32 32 226 500	KT2265	256
30 24 040 630	H4063	348	32 32 322 300	KT3223	257
30 24 040 640	H4064	6	32 32 336 400	KT3364	257
30 24 040 640	H4064	348	32 32 356 400	KT3564	257
30 24 040 650	H4065	6	32 33 012 100	KE1210	259
30 24 040 650	H4065	349	32 33 012 400	KE1240	258
30 69 050 010	H5001	15	32 33 012 800	KE1280	258
30 69 050 010	H5001	341	32 33 019 160	KE1916	259
30 69 050 110	H5011	14	32 33 029 810	KE2981	258
30 69 050 110	H5011	375	32 33 049 100	KE4910	259
30 69 050 120	H5012	14	32 33 049 110	KE4911	259
30 69 050 120	H5012	376	32 33 049 120	KE4912	259
30 69 050 130	H5013	14	32 33 049 130	KE4913	260
30 69 050 130	H5013	376	32 33 049 140	KE4914	260
30 69 050 140	H5014	15	32 33 068 200	KE6820	258
30 69 050 140	H5014	376	32 33 079 551	KE7955N	260
30 69 050 150	H5015	15	34 01 000 010	P57001	355
30 69 050 150	H5015	376	34 01 000 020	P57002	355
30 69 050 160	H5016	15	34 02 005 000	P5705	351
30 69 050 160	H5016	376	34 02 012 000	P5712	351
30 69 050 230	H5023	8	34 02 025 000	P5727	350
30 69 050 230	H5023	346	34 02 043 000	P5728	351
30 69 051 010	H5101	17	34 02 044 000	P5729	352
30 69 051 010	H5101	377	34 02 060 000	P5760	350
30 69 051 020	H5102	17	34 02 060 001	P5763	350
30 69 051 020	H5102	377	34 02 060 002	P5760T	354
30 69 051 030	H5103	17	34 02 063 000	P5763R	350
30 69 051 030	H5103	377	34 02 107 000	P5723	351
30 69 051 040	H5104	18	34 02 108 000	P5723T	354
30 69 051 040	H5104	377	34 02 112 000	P5727T	354
30 69 051 050	H5105	18	34 02 113 000	P5728T	354
30 69 051 050	H5105	378	34 02 114 000	P5729T	354
30 69 051 060	H5106	18	34 02 115 000	P5730	351
30 69 051 060	H5106	378	34 02 116 000	P5731	352
30 69 051 070	H5107	18	34 02 117 001	P5732T	355
30 69 051 070	H5107	378	34 02 118 000	P5750	349
30 69 051 080	H5108	18	34 02 118 001	P5750T	353
30 69 051 080	H5108	378	34 02 119 000	P5750.2T	349
30 69 051 090	H5109	19	34 02 120 000	P5750.2R	350
30 69 051 090	H5109	378	34 02 121 000	P5729B	352
30 69 051 100	H5110	19	34 02 122 000	P5733W	352
30 69 051 100	H5110	379	34 02 123 000	P5733S	352
30 69 051 110	H5111	19	34 02 124 000	P5733G	353
30 69 051 110	H5111	379	34 02 125 000	P5734	353
30 69 052 010	H5020	9	34 02 126 000	P5734B	353
30 69 052 010	H5020	356	34 02 126 001	P5734T	355
30 69 052 020	H5021	9			
30 69 052 020	H5021	356			
30 69 052 030	H5022	16			
30 69 052 030	H5022	341			
30 70 000 009	H7009	346			
30 80 000 013	H8013	346			
31 04 139 600	A1396	375			
31 04 139 611	A1396.1	375			
31 04 139 800	A1398	374			
31 04 139 811	A1398.1	374			
31 05 213 050	A6110	288			
31 05 213 051	A6111	288			
31 05 213 054	A6114	288			
31 05 213 055	A6115	288			
31 06 213 150	A6310	288			
31 06 213 151	A6311	288			
31 06 213 152	A6312	288			
31 06 213 153	A6313	288			
31 06 213 240	A6210	287			
31 06 213 241	A6211	288			
31 06 213 242	A6212	287			
31 06 213 243	A6213	288			
31 16 300 400	A3004	326			
31 16 301 000	A3010	326			
31 16 336 600	A3366	326			
31 16 336 900	A3369	326			
31 32 510 900	C5109	141			
31 46 000 250	A4001	379			
31 46 000 400	A4002	379			
31 46 000 600	A4003	380			
31 46 001 600	A4004	380			
31 46 010 400	A4005	380			
31 46 010 600	A4006	380			
31 46 011 000	A4007	380			
31 47 010 020	A5102	381			
31 47 020 010	A5201	381			
31 47 030 010	A5301	381			
31 47 040 010	A5401	381			
31 99 900 000	A9000	380			
32 32 224 400	KT2244	257			



# Button and special batteries

GP SILVER OXIDE					Diameter [mm]	Thickness [mm]	ALKALINE				
GP order code	Type	Reference	SR**	SR***			GP order code	AG**	101 - 199	LR**	LR***
-	317	SR516SW, SR62, SR516, SB-AR, 280-58, V317, D317, GP317, 616, 317, SR516W, 317X, 317A	SR62	SR516	5,8	1,6	-	-	-	-	-
-	321	SR616SW, SR65, SR616, SB-AF/DF, 280-73, DA, V321, D321, GP321, 611, 321, SR618, 321A, 321X, SB-AF, E321	SR65	SR616	6,8	1,6	-	-	-	-	-
<b>B3357F1</b>	357	SR44W, SR44, SR1154, SB-B9, 280-62, V357, D357, 228, S1145E, GP357, AG13, 357, 303, CA18, SG13, EPX76, 10L14, A357, 357X, 357A, D357H, MS76, V76XP, S76E, 357/303, MS76, AG357, SR1154PW, EXP76, E357, E357/303EN, 1128MP, 1166A, AG13, D76A, G13A, GPA7, GPA76, LR44, LR1154, L1154, PX675A, PX76A, RPX675, S76, V13GA, RW82, KA, A76, 208-904, SB-F9, G13-A, CA18, CA19, LR44, GP76A, L1154H, A-76, AG14, AG-14, KA76, MS76H, CR44, LR44H, L1154G, LR44G, GPS76A, L1154C, L1154F, GPA75, GDA76, A613, LR44GD	SR44	SR1154	11,6	5,4	<b>B13762 B1376 B7970 (RAVER)</b>	AG13	A76	LR44	LR1154
-	362	SR721SW, SR58, SR721, SB-AK/DK, 280-29, S, V362, D362, 601, S721E, GP362, AG11, AG-11, 362, SG11, 362A, SR720, 362X, 362/361, RW310, L721, LR721, SB-AK, E362	SR58	SR721	7,9	2,1	-	AG11	162	LR58	LR721
<b>B3364F1</b>	364	SR621SW, SR60, SR621, SB-AG/DG, 280-34, T, V364, D364, 602, S621E, GP364, AG1, AG-1, 364, L621, LR621, SG1, LR60, LR620, SW621, GP164, 364X, 364A, AG1/364A, SB-AG, E364	SR60	SR621	6,8	2,1	-	AG1	164	LR60	LR621
-	371	SR920SW, SR69, SR921, SB-AN, 280-31, V371, D371, 605, S921E, GP371, AG6, AG-6, 371, CX921, SR290SW, 371, SR69, SG6, LR921, LR920SW, L921, 371A, 371X, 370	SR69	SR921	9,5	2,1	-	AG6	171	LR69	LR921
<b>B3377F1</b>	377	SR626SW, SR66, SR626, SB-AW, 280-39, BA, V377, D377, 606, S626E, GP377, AG4, AG-4, 377, L626, SG4, LR626, LR66, SR628SW, E377, E377CA, LR626SW, 377A, SR262SW, 377X, 377S, GP177, SR6265W, 377/376, E377A, SR66SW, SR625SW, 377BA, CR626SW, AG4/377, AG04	SR66	SR626	6,8	2,6	-	AG4	177	LR66	LR626
-	379	SR521SW, SR63, SR521, SB-AC/DC, 280-59, JA, V379, D379, 618, GP379, S521E, 379, LR521, AG0, 379A, 379X, AG0, AG-0, 521A, UC379, SR418SW, SB-AC, 379LD, E379	SR63	SR521	5,8	2,1	-	AG0	179	LR63	LR521
-	386	SR43W, SR43, SR1142, SB-B8, 280-41, H, V386, D386, 260, S1142E, GP386, AG12, AG-12, 386, 301, SG12, LR42, 386A, 386X, CR43, LR1144, RW44, SR1142PW, 386B, BSR43H, SR43H, E386, 186, 1176A, 186-1, G12A, GP86A, L1142, LR1142, LR43, RW84, V12GA, GP186, L1142F, 10L124, G12-A	SR43	SR1142	11,6	4,2	<b>B13861 B1386</b>	AG12	186	LR43	LR1142
<b>B3389F1</b>	389	SR1130W, SR54, SR1130, SB-BU, 280-15, M, V389, D389, 626, S1131E, GP389, AG10, AG-10, 389, 390, 189, L1131, G10, V10GA, LR1130, GP189, LR54, SG10, A389, L1131, L1131C, L1131D, RW89, LR1130S, LR1131, L1131/D, LR1130H, 389A, 389E, 389X, L1133, SR1131, L1131, L1131F, L1131F, L1131H, LR1130X, L-1131, SR1130PW, L1130, LH1130, E389	SR54	SR1130	11,6	3,1	<b>B13892 B1389</b>	AG10	189	LR54	LR1130
<b>B3392F1</b>	392	SR41W, SR736, SB-B1, 280-13, K, V392, D392, 247D, S736E, AG3, AG-3, GP392, LR736, 392, 192, L736, G3, V3GA, LR41, SG3, ASG3, G3A, V36A, 92A, GP192, 392X, 384, SR41, TR41SW, SR41SW, 247B, SP392, S736S, 392A, 392X, L736H, L736S, SR736PW, RW47, RW47S, GP392-A1, SR41, E392, LR41H, AG03	SR41	SR736	7,9	3,6	<b>B13921 B13925</b>	AG3	192	LR41	LR736
-	394	SR936SW, SR936, SB-A4, 280-17, V394, D394, 625, 394, GP394, AG9, AG-9, 394, SG9, LR36, LR936, SR45, RW33, 394A, 394X, SR9365W, E394		SR936	9,5	3,6	-	AG9	194	LR45	LR936
-	395	SR926SW, SR57, SR927, SB-AP/DP, 280-48, LA, V395, D395, 610, 395, GP395, S926E, 395, SG7, L926, SW927, 927, 395A, 395X, SB-AP, E395, 399	SR57	SR927	9,5	2,6	-	AG7	195	LR57	-
-	396	SR726W, SR59, SR726, SB-BL, 280-52, V, V396, D396, 612, GP396, S726E, 396/397, SG2, 396A, 396X, SR726PW, E396	SR59	SR726	7,9	2,6	-	AG2	106	LR59	-
-	-	V23GA, MN21, A23	-	-	10,22	28,5	<b>B1300 B13001</b>	-	-	-	-
-	-	A27, MN24, A90	-	-	8	28,5	<b>B1301 B13011</b>	-	-	-	-
-	-	MN11	-	-	10,22	16,5	<b>B1302 B13021</b>	-	-	-	-
-	-	29A, A29, 32A, A32, L822	-	-	8,0	21,9	<b>B13951</b>	-	-	-	-
-	-	4001, AM5, E90, KN, LADY, LR1, MN9100, MN9100/N, N, UM-5, UM5, LR01, KN-2, 810, 910A, LR1-N, LR1/E90	-	-	12	30,2	<b>B1305</b>	-	-	LR1	-
-	-	LR9, CA16, V625U, EPX625G, PX625A, GP625A, A625, L1560, 625A, MR9P, KA625, R625, E625G, V625U, MR09, EPX625, RPX625, KX615, HD1560, 1124MP, E625N, HG-625R, V13PX, EPX13, V625PX, HD625, PN625, RM625, 4625, H1560, M01, M20, 8930	-	-	15,6	5,95	<b>B1325</b>	-	-	LR9	-
-	-	GP25A, AAAA, MN2500, LR8, D425, E96	-	-	8,3	42,5	<b>B1306</b>	-	-	LR8	-
-	-	PX28A, A544, 28PXA, 4LR44, 476A, 4G13, GP476, K28, V28, PX28AB, L1325, 1414A, V4034PX, PX28L, K28L, L544, L544BP, V28PXL, 2CR1/3N, 2CR1-3N, CR28L, 1406LC, 2CR11108	-	-	13	25,2	<b>B1303</b>	-	-	4LR44	-



Lead-acid accumulators – 5-year optimal service life	Order code	B9641	B9651	B9659	B9682	B9652	B9672	B9653	B9679	B9691
	Parameters	6 V/4 Ah	6 V/1.3 Ah	6 V/7 Ah	6 V/12 Ah	12 V/1.3 Ah	12 V/2.2 Ah	12 V/4.5 Ah	12 V/5 Ah	12 V/7.0 Ah
	Terminal	4.7 mm	4.7 mm	4.7 mm	4.7 mm	4.7 mm	4.7 mm	4.7 mm	6.3 mm	4.7 mm
Electronic security systems	Electronic security systems	-	yes	yes	yes	yes	yes	yes	yes	yes
	Electronic fire alarm systems	-	yes	yes	yes	yes	-	yes	yes	yes
	UPS	-	-	yes	yes	-	-	yes	yes	yes
	Emergency lighting	yes	-	-	-	-	-	-	-	yes
	Elevators – power for emergency calls and lighting	-	-	-	-	yes	-	yes	yes	yes
Jablotron control panels	JA82Y	-	-	-	-	-	yes	-	-	-
	JA100K(R)	-	-	-	-	-	yes	-	-	-
	JA83	-	-	-	-	-	-	-	-	yes
	JA106K	-	-	-	-	-	-	-	-	yes
PARADOX	90 % use	-	-	-	-	-	-	-	-	yes
	10 % use	-	-	-	-	-	-	-	-	-



Lead-acid accumulators – 5-year optimal service life	Order code	B9654	B9674	B9675	B9656V	B9656	B9655	B9683	B9684	B9685
	Parameters	12 V/7.2 Ah	12 V/7.2 Ah	12 V/9 Ah	12 V/15 Ah	12 V/12 Ah	12 V/18 Ah	12 V/26 Ah	12 V/40 Ah	12 V/65 Ah
	Terminal	4.7 mm	6.3 mm	6.3 mm	6.3 mm	6.3 mm	12 × 12 × 2 mm	14 × 12 × 2 mm	M6	M8
Electronic security systems	Electronic security systems	yes	yes	-	-	yes	yes	-	-	-
	Electronic fire alarm systems	yes	-	-	-	yes	yes	-	-	-
	UPS	yes	yes	yes	-	yes	yes	yes	yes	yes
	Emergency lighting	yes	-	-	-	-	yes	yes	yes	yes
	Elevators – power for emergency calls and lighting	yes	-	-	-	yes	yes	-	-	-
Jablotron control panels	JA82Y	-	-	-	-	-	-	-	-	-
	JA100K(R)	yes	-	-	-	-	-	-	-	-
	JA83	yes	-	-	-	-	yes	-	-	-
	JA106K	yes	-	-	-	-	yes	-	-	-
PARADOX	90 % use	yes	-	-	-	-	-	-	-	-
	10 % use	-	-	-	-	-	yes	-	-	-



# Battery chargers

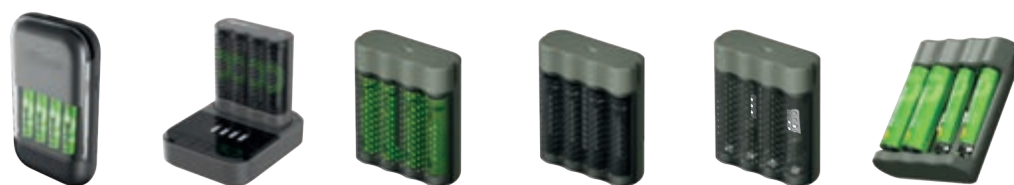

Order code	B56499	B50460D	B53457	B53455	B53450	B50449
Model number	S491	P461	M451	M451	M451	B441
Series	Charge 10	Pro	Speed	Speed	Speed	Recharge
Charger connection	separated AC cord	USB	USB	USB	USB	USB
Power supply	100-240 V AC	USB 5 V/2 A	5 V/1 A	5 V/1 A	5 V/1 A	USB 5 V/1 A
Size of the charged cells	AAA, AA	AAA, AA	AAA, AA	AAA, AA	AAA, AA	AAA, AA
Special features	Eco mode	capacity check, docking station	-	-	-	-
Number of cells inside the package	4	4	4	4	-	4
Type of cells inside the package	AA ReCyko Charge 10	AA ReCyko Pro	AA ReCyko 2 700	AA ReCyko Pro	-	AA Recharge 1300, AAA Recharge 650
Charging time of the enclosed celled	0:10	1:20 - 2:40	2:45 - 5:30	2:00 - 4:00	-	2:00 - 4:00
Number of charging channels	4	4	4	4	4	2
Number of batteries charged	1 to 4	1 up to 4	1 to 4	1 to 4	1 to 4	2 or 4
Charging current for AA	10 000 mA	1 730 mA/870 mA	1 100-550 mA	1 100-550 mA	1 100-550 mA	770 mA/380 mA
Charging current for AAA	1 500 mA	700 mA/350 mA	730-370 mA	730-370 mA	730-370 mA	300 mA
Charging current for C	-	-	-	-	-	-
Charging current for D	-	-	-	-	-	-
Charging current for 9 V	-	-	-	-	-	-
Charging time AA 2 700 mAh	0:30	1:45/3:30	2:45 - 5:30	2:45 - 5:30	2:45 - 5:30	4:00 - 8:00
Charging time AAA 1 000 mAh	0:45	1:30 - 3:15	1:30 - 3:30	1:30 - 3:30	1:30 - 3:30	4:00



Order code	B55630	B50829	B50444	B51214	B50224	B50457
Model number	B631	E821	B441	E211	E221	M452
Series	Everyday	Economy	Economy	Economy	Economy	Speed
Charger connection	USB	USB	USB	USB	USB	USB
Power supply	5 V/2 A	USB 5 V/1 A	USB 5 V/1 A	5 V/1 A	USB 5 V/1 A	USB 5 V/1 A
Size of the charged cells	AAA, AA, C, D, 9 V	AAA, AA	AAA, AA	AAA, AA	AAA, AA	AAA, AA
Special features	-	-	-	-	-	-
Number of cells inside the package	-	8	4	2	2	4
Type of cells inside the package	-	AA ReCyko 2 100, AAA ReCyko 850	AA ReCyko 2 100	AA ReCyko 2 100	AA ReCyko 2 100	AA ReCyko Pro
Charging time of the enclosed celled	-	9:00	3:00/6:00	8:00	8:00	2:45 - 5:30
Number of charging channels	4	4	2	1	1	4
Number of batteries charged	2 and 4	2, 4, 6 or 8	2 or 4	2	2	1 up to 4
Charging current for AA	370 mA	250 mA	770 mA/380 mA	300 mA	300 mA	1 100-550 mA
Charging current for AAA	290 mA	250 mA	300 mA	300 mA	300 mA	730-370 mA
Charging current for C	550 mA	-	-	-	-	-
Charging current for D	550 mA	-	-	-	-	-
Charging current for 9 V	40-20 mA	-	-	-	-	-
Charging time AA 2 700 mAh	8:00	10:00	4:00 - 8:00	10:00	10:00	2:45 - 5:30
Charging time AAA 1 000 mAh	4:00	5:00	2:30 - 3:30	4:00	4:00	1:30 - 3:30





	N9221	N9341	N9331	N9321	N9361
Order code	BCL-20D	BCN-42D	BCN-41D	BCN-40	BCN-60U
Type	Li-ion, LiFePo4, NiMH	NiMH	NiMH	NiMH	NiMH
Type of rechargeable cells	Li-ion, LiFePo4, NiMH	NiMH	NiMH	NiMH	NiMH
Power supply	5 V/2 A	5 V/1 A	5 V/1 A	5 V/1 A	5 V/2 A
Size of the charged cells	10440 – 26650, AAA, AA, C, SC	AAA, AA	AAA, AA	AAA, AA	AAA, AA, C, D, 9 V
Special features	capacity measurement, recovery modes, lithium battery charging	capacity measurement, recovery modes	-	-	-
LCD display	yes	yes	yes	-	-
Type of cells inside the package	-	4× AA NiMH 2 700	4× AA NiMH 2 700	-	-
Charging time of the individual celles	-	3:00	4:00	-	-
Number of charging channels	2	4	4	4	7
Number of batteries charged	1 and 2	1 to 4	1 to 4	1 to 4	1 to 6
Charging current for AA	1 000 mA	1 000–250 mA	1 000–500 mA	300 mA	500 mA
Charging current for AAA	1 000 mA	1 000–250 mA	1 000–500 mA	300 mA	500 mA
Charging current for C	1 000 mA	-	-	-	500 mA
Charging current for D	-	-	-	-	500 mA
Charging current for 9 V	-	-	-	-	30 mA
Charging time AA 2 700 mAh	3:00	3:00 – 12:00	3:00 – 4:00	10:00	6:30
Charging time AAA 1 000 mAh	1:15	1:15 – 5:00	1:15 – 2:00	4:00	2:30



Order code	P8569	P8555	P8567	P8566	P8572	P8571
Type	PHR19	CHR35	PHR17	PHR16	CHR41	CH46
Usage	OUTDOOR	OUTDOOR	SPORT	SPORT	OUTDOOR/SPORT	OUTDOOR/SPORT
Source of light	2× Osram SMD LED	CREE SMD LED	3× CREE SMD LED	2× CREE SMD LED	CREE SMD LED	CREE SMD LED
Max. light output	1 200 lm	600 lm	500 lm	300 lm	300 lm	300 lm
Max. beam distance	110 m	130 m	85 m	50 m	157 m	157 m
Number of lighting modes	11	5	10	9	4	4
Lighting modes	Turbo; Spot: 5%; 20%; 60%; 100%; Flood: 2.5%; 10%; 60%; 100%; SOS; Red LED light	Turbo, 100%, 20%, 5%, red LED flashing	Turbo, 2.5%, 30%, 100%; SOS; Red LED light; Flood; red: 50%, 100%; flashing	Turbo, 3%, 25%, 100%; SOS; Red LED light; red: 50%, 100%; flashing	AUTO, 100%, 50%, 2% flicker	100%, 50%, 2%, flicker
Max. luminous time	100 h	60 h	100 h	45 h	69 h	69 h
Rechargeable	yes	yes	yes	yes	yes	-
Power supply	Li-ion (2 550 mAh) / 2× CR123A	Li-ion (2 600 mAh)	Li-Po (1 600 mAh)	Li-Po (800 mAh)	3× AAA (HR03)	3× AAA
Waterproof	IPX8	IPX4	IPX6	IPX6	IPX6	IPX6
Special features	button lock mode	button lock mode	button lock mode	button lock mode	button lock mode, automatic dimming	touchless dimming
Dimensions	91,5 × 39 × 51 mm	106 × 27 × 27 mm	56 × 38 × 39 mm	56 × 38 × 34 mm	34 × 46 × 56 mm	34 × 46 × 56 mm
Weight	90/151 g	153 g	59,5 g	44 g	110 g	110 g



Order code	P8574	P8573	P8584	P8583	P8582	P8551P
Type	CHW54	CHW53	CH44	CH43	CH42	CH31
Usage	WORK	WORK	OUTDOOR	OUTDOOR/SPORT	MULTIUSE	MULTIUSE
Source of light	2× CREE SMD LED	2× CREE SMD LED	2× SMD LED	2× SMD LED + LED	2× SMD LED	4× LED
Max. light output	375 lm	280 lm	300 lm	150 lm	110 lm	40 lm
Max. beam distance	110 m	90 m	60 m	45 m	40 m	8 m
Number of lighting modes	4	6	6	5	4	3
Lighting modes	Turbo; 100%; 30%; 17%	Turbo; 100%; 40%; 25%; red LED light; flashing	100%; 60%; 25%; 12%; red LED light; flashing	100%; 45%; 25%; red LED light; flashing	100%; 65%; 40%; flicker	100%; 30%; flicker
Max. luminous time	26 h	25 h	36 h	36 h	15 h	6 h
Rechargeable	-	-	-	-	-	-
Power supply	3× AAA	3× AAA	3× AAA	3× AAA	3× AAA	2× CR2025
Waterproof	IPX5	IPX5	IPX4	IPX4	IP43	-
Special features	touchless dimming	-	touchless light swithing	-	-	-
Dimensions	66 × 49 × 37 mm	66 × 49 × 37 mm	61 × 47 × 37 mm	61 × 47 × 37 mm	59 × 46 × 34 mm	37 × 36 × 20 mm
Weight	62 g/98 g	95 g	42 g/78 g	42 g/78 g	29 g/65 g	31 g



Order code	P3537	P3532	P3528	P3536	P3541
Source of light	COB LED	COB LED (white, red)	COB LED	LED + COB LED (green, red)	COB LED + LED
Maximal light output	110 lm	125 lm	150 lm	220 lm	380 lm
Maximal beam distance	15 m	20 m	20 m	100 m	30 m
Number of lighting modes	3	3	3	7	4
Lighting modes	COB LED 100 %, COB LED 50 %, blinking	COB LED 100 %, COB LED 50 %, COB LED - red blinking	COB LED 100 %, COB LED 50 %, SOS	COB LED + LED 100 %, LED 100 %, LED 50 %, blinking, COB LED - white, COB LED - red, COB LED - green	COB LED 100 %, COB LED 50 %, LED 100 %, LED 50 %
Runtime	20-40 hrs	9-19 hrs	8-27 hrs	45-160 hrs	3-12 hrs
Waterproof	-	IP44	-	IP43	IP43
Rechargeable	-	-	-	-	yes
Power supply	3× AAA	3× AAA	3× AAA	3× AAA	Li-pol (1 200 mAh)
Special features	-	battery protection	-	quick switch ON/OFF	hand-operated switching, quick switch ON/OFF, battery protection
Dimensions	60 × 18 × 40 mm	69 × 43 × 46 mm	60 × 40 × 40 mm	65 × 45 × 50 mm	300 × 3.2 × 20 mm
Weight	21 g/56 g	54 g/89 g	53 g/88 g	65 g/100 g	73 g



Order code	P3521	P3539	P3531	P3534	P3535	P3542
Source of light	LED + 2× red LED	CREE LED + 2× red LED	CREE LED + COB LED (green, red) + red LED (rear light)	CREE LED	CREE LED + 4× SMD	COB LED + LED
Maximal light output	85 lm	330 lm	330 lm	230 lm	110 lm	500 lm
Maximal beam distance	65 m	200 m	65 m	80 m	55 m	130 m
Number of lighting modes	4	5	7	4	3	7
Lighting modes	LED 100 %, LED 50 %, red LED flashing, red LED blinking	CREE LED 100 %, CREE LED 50 %, SOS, red LED flashing, red LED blinking	COB LED + CREE LED 100 %, CREE LED 100 %, CREE LED 50 %, CREE LED - blinking, COB LED - white, COB LED - green, COB LED - red	CREE LED 100 %, CREE LED 50 %, CREE LED 20 %, SOS	CREE LED 100 %, CREE LED 50 %, 4× SMD LED	LED 25 %, LED 50 %, LED 100 %, COB LED 25 %, COB LED 50 %, COB LED 100 %, LED + COB LED
Runtime	50-120 hrs	50-87 hrs	18-72 hrs	3-13 hrs	7 h	4-6.5 hrs
Waterproof	IP43	IP43	IP44	-	ano	yes
Rechargeable	-	-	-	yes	Li-pol (850 mAh)	Li-pol
Power supply	3× AAA	3× AAA	3× AAA + 1× CR2032	Li-pol (1 200 mAh)	-	yes (IP44)
Special features	quick switch ON/OFF	quick switch ON/OFF, focus	quick switch ON/OFF	hand-operated switching, quick switch ON/OFF, battery protection	funkce rychlého vypnutí, funkce ochrany baterie	hand-operated switching, quick switch ON/OFF, battery protection
Dimensions	58 × 38 × 44 mm	60 × 48 × 43 mm	65 × 32 × 39 mm	61 × 37 × 31 mm	47 × 31 × 54 mm	70 × 45 × 35 mm
Weight	54 g/89 g	70 g/105 g	80 g/115 g	60 g	64 g	90 g



Order code	P4536	P4533	P4534	P4539	P4532	P4525	P4518	P4535	P4538
Type	RECHARGEABLE								
Source of light	2× COB LED	COB LED	COB LED	COB LED	COB LED + LED	COB LED + 5× LED	COB LED + LED	2× COB LED + LED	SMD LED + LED
Maximal light output	2 000 lm	1 000 lm	600 lm	1 000 lm	470 lm	500 lm	380 lm	670 lm	700 lm
Maximal beam distance	70 m	45 m	35 m	40 m	45 m	30 m	27 m	40 m	45 m
Number of lighting modes	5	3	2	3	3	3	3	3	3
Lighting modes	2× COB LED 100 %, 2× COB LED 50 %, 1× COB LED 100 %, 1× COB LED 50 %, 1× COB LED 25 %	COB LED 100 %, COB LED 50 %, COB LED 20 %	COB LED 100 %, COB LED 50 %	COB LED 100 %, COB LED 50 %, COB LED 25 %	COB LED 100 %, COB LED 50 %, LED	COB LED 50 %, COB LED 100 %, 5× LED	COB LED 50 %, COB LED 100 %, LED 100 %	1× COB LED 100 %, 2× COB LED 100 %, LED 100 %	SMD LED BOOST, SMD LED 100 %, LED 100 %
Runtime	3.5–14.5 hrs	3.5–15.5 hrs	2.5–3.5 hrs	3–17 hrs	2.5–8 hrs	2–26 hrs	3.5–24 hrs	2–10 hrs	3–6 hrs
Focus	–	–	–	–	–	–	–	–	–
Shock-resistance	yes	yes	yes	yes	yes	yes	yes	–	–
Waterproof	–	yes (IP44)	yes (IP44)	yes (IP44)	–	yes (IP43)	yes (IP43)	–	–
Rechargeable	yes	yes	yes	yes	yes	yes	yes	yes	yes
Power supply	Li-Ion accumulator	Li-Ion accumulator	Li-Ion accumulator	Li-Ion	Li-Ion accumulator	Li-Ion accumulator	Li-Ion accumulator	Li-Ion accumulator	Li-Ion
Battery type	8 000 mAh/3.7 V	4 400 mAh/3.7 V	3 000 mAh/3.7 V	2 200 mAh/3.7 V	1 800 mAh/3.7 V	2 000 mAh/3.7 V	2 500 mAh/3.7 V	2 200 mAh/3.7 V	1 200 mAh/3.7 V
Batteries included	yes	yes	yes	yes	yes	yes	yes	yes	yes
Charging time	7 hrs	7.5 hrs	3.5 hrs	3 hrs	3.5 hrs	3 hrs	4 hrs	3 hrs	2 hrs
Power connector type	USB-C	micro USB-B	micro USB-B	USB-C	5.5 × 2.1/10 mm	3.0 × 1.0/12 mm	3.0 × 1.0/12 mm	USB-C	USB-C
Led indication of the charging process	yes	yes	yes	yes	yes	yes	yes	yes	yes
Led indication of the accumulator state	yes	yes	yes	–	–	–	–	yes	yes
Special features	quick switch ON/OFF, battery protection	quick switch ON/OFF, battery protection	battery protection, powerbank function	powerbank function, quick switch ON/OFF, battery protection	quick switch ON/OFF, battery protection	quick switch ON/OFF, battery protection	quick switch ON/OFF, battery protection	powerbank function, quick switch ON/OFF, battery protection	battery protection function, light BOOST function
Facilities	swivel handle, 4× magnet	swivel handle	swivel handle	magnet, stand, clip	swivel handle, clip, 1× hook, 2× magnet	swivel handle, 1× hook, 3× magnet	swivel handle, 1× hook, 2× magnet	1× hook, 4× magnet	2× magnet
Accessories	USB cable	USB cable	USB cable	USB cable	charging adapter	charging adapter + car adapter	charging adapter, car adapter	USB cable	USB cable
Material	ABS plastic + rubber	ABS plastic + rubber	Nylon + TPR	ABS plastic	ABS plastic + rubber	ABS plastic + rubber	ABS plastic	ABS + TPR + rubber	ABS plastic + rubber
Dimensions	214 × 140 (280) × 56 mm	172 × 45 × 126 mm	172 × 45 × 126 mm	104 × 39 × 94 mm	52 × 41 × 242 mm	76 × 66 × 317 mm	56 × 50 × 240 mm	35 × 33 × 257 mm	37 × 14 × 240 mm



Order code	P4537	P4531	P4540	P4541	P4542	P4543	P4113	P4112	P3888
Type	RECHARGEABLE						BATTERY		
Source of light	COB LED + SMD LED	COB LED + LED	COB LED + LED	COB LED + LED	COB LED cool + COB LED warm	COB LED	COB LED	2× COB LED + LED	COB LED
Maximal light output	330 lm	400 lm	750 lm	450 lm	900 lm	1 200 lm	700 lm	350 lm	180 lm
Maximal beam distance	45 m	40 m	35 m	100 m	35 m	60 m	35 m	110 m	45 m
Number of lighting modes	3	3	6	3	16	3	3	2	2
Lighting modes	COB LED 100 %, COB LED 33 %, SMD LED 100 %	COB LED 100 %, COB LED 50 %, LED 100 %	COB LED 100 %, COB LED 40 %, COB LED 20 %, red COB LED glow, red COB LED flashing, LED 100 %	COB LED 100 % + LED 100 %, COB LED 100 %, LED 100 %	4× COB LED 100 %, 75 %, 50 %, 25 % (warm/neutral/cool)	COB LED 100 %, COB LED 30 %, flashing	COB LED 35 %, COB LED 60 %, COB 100 %	2× COB LED 100 %, LED 100 %	COB LED 100 %, COB LED 50 %
Runtime	3–7 hrs	3–8.5 hrs	2–13 hrs	7–16 hrs	3.5–12.5 hrs	3.5–6.5 hrs	8–14 hrs	10–20 hrs	16–24 hrs
Focus	–	–	–	–	–	–	–	–	–
Shock-resistance	yes	yes	yes	yes	yes	yes	yes	–	yes
Waterproof	yes (IP43)	yes (IP43)	yes (IP44)	yes (IP44)	–	yes (IP44)	yes (IP43)	–	–
Rechargeable	yes	yes	yes	yes	yes	yes	–	–	–
Power supply	Li-Ion	Li-Ion accumulator	Li-Ion	Li-Ion	Li-Ion	Li-pol	4× AA	3× AA	3× AAA
Battery type	1 200 mAh/3.7 V	2 000 mAh/3.7 V	1 800 mAh/3.7 V	2 000 mAh/3.7 V	2× 2 000 mAh/3.7 V	2 000 mAh/3.7 V	LR6 (1.5 V)	LR6 (1.5 V)	LR03 (1.5 V)
Batteries included	yes	yes	yes	yes	yes	yes	–	–	–
Charging time	2–4 hrs	3 hrs	2.5 hrs	3.5 hrs	4.5 hrs	3 hrs	–	–	–
Power connector type	micro USB-B	micro USB-B	USB-C	USB-C	USB-C	USB-C	–	–	–
Led indication of the charging process	yes	yes	yes	yes	yes	yes	–	–	–
Led indication of the accumulator state	yes	yes	–	–	yes	yes	–	–	–
Special features	quick switch ON/OFF, battery protection	quick switch ON/OFF, battery protection	quick switch ON/OFF, battery protection	battery protection	battery protection, powerbank	quick switch ON/OFF, battery protection	quick switch ON/OFF	–	–
Facilities	swivel handle, 1× clip, 1× magnet, 1× hook	swivel handle, clip, 1× hook, 1× magnet	rotating reflector, magnet, hook	magnet, hook	magnet, rotating stand, hook	magnet, rotating stand, clip	swivel handle	swivel handle	break-over handle, 1× hook, 2× magnet
Accessories	USB cable	USB cable	USB cable	USB cable	USB cable	USB cable	–	–	–
Material	ABS plastic + rubber	plastic + rubber	plastic	plastic	plastic	plastic	plastic	plastic	ABS plastic
Dimensions	41 × 29 × 154 mm	52 × 32 × 165 mm	28 × 35 × 147/285 mm	43 × 43 × 197 mm	125 × 45 × 95 mm	80 × 45 × 80 mm	145 × 105 × 35 mm	135 × 100 × 40 mm	59 × 30 × 133 mm





	ZS2812	ZS2822	ZS2832
Order code			
Series	ACCO		
Source of light	LED	LED	LED
Power	10 W	20 W	30 W
Light output	1 000 lm	2 000 lm	3 000 lm
Luminous efficiency	100 lm/W	100 lm/W	100 lm/W
Colour temperature	6 500 K	6 500 K	6 500 K
Light colour	cool white	cool white	cool white
IP rating	IP54	IP54	IP54
Colour rendering index (CRI)	Ra > 80	Ra > 80	Ra > 80
Power supply	accumulator	accumulator	accumulator
Battery	Li-Ion 4 400 mAh	Li-Ion 6 600 mAh	Li-Ion 10 000 mAh
AKU lighting time	3 – 10 hours	3 – 10 hours	3 – 10 hours
Voltage	5 V DC 220–240 V AC	5 V DC 220–240 V AC	5 V DC 220–240 V AC
Dimming	yes	yes	yes
Lifetime	25 000 hours	25 000 hours	25 000 hours
Working temperature range	-20 °C to +40 °C	-20 °C to +40 °C	-20 °C to +40 °C
Beam angle	120°	120°	120°
Dimensions	212 × 177 × 224 mm	266 × 220 × 273 mm	292 × 219 × 273 mm
Body material	aluminum	aluminum	aluminum
Material of the diffuser	glass	glass	glass
Mechanical impact protection	-	-	-



	ZS3322	ZS3332	ZS3342	ZS2221.2	ZS2231.2
Order code					
Series	ILIO			HOBBY SLIM	
Source of light	LED	LED	LED	LED	LED
Power	21 W	31 W	51 W	2× 20,5 W	2× 30 W
Light output	1 900 lm	2 800 lm	4 600 lm	2× 1 600 lm	2× 2 400 lm
Luminous efficiency	90 lm/W	90 lm/W	90 lm/W	80 lm/W	80 lm/W
Colour temperature	4 000 K	4 000 K	4 000 K	4 000 K	4 000 K
Light colour	neutral white	neutral white	neutral white	neutral white	neutral white
IP rating	IP44	IP44	IP44	IP65	IP65
Colour rendering index (CRI)	Ra > 80	Ra > 80	Ra > 80	Ra > 80	Ra > 80
Power supply	mains powered	mains powered	mains powered	mains powered	mains powered
Battery	-	-	-	-	-
AKU lighting time	-	-	-	-	-
Voltage	220–240 V~	220–240 V~	220–240 V~	220–240 V~	220–240 V~
Dimming	-	-	-	-	-
Lifetime	25 000 hours	25 000 hours	25 000 hours	25 000 hours	25 000 hours
Working temperature range	-20 °C to +40 °C	-20 °C to +40 °C	-20 °C to +40 °C	-20 °C to +40 °C	-20 °C to +40 °C
Beam angle	110°	110°	110°	120°	120°
Dimensions	215 × 185 × 250 mm	240 × 185 × 275 mm	270 × 185 × 275 mm	860 × 860 × 1 850 mm	860 × 860 × 1 850 mm
Body material	aluminum	aluminum	aluminum	aluminum	aluminum
Material of the diffuser	plastic (PC)	plastic (PC)	plastic (PC)	glass	glass
Mechanical impact protection	IK10	IK10	IK10	IK08	IK08



	H4020	H3010	H2017	H2050
Order code				
Series	GoSmart	ADVANCED	BASIC	
Type	IP-750A	EM-10AHD	EM-07HD	EM-03M 2WIRE
LCD size	7"	7"	7"	7"
LCD resolution	Full HD 1080p	1080p	720p	480p
Button design	without buttons, touchscreen	touchscreen	mechanical	mechanical
Number of conductors	4	4	4	2
Power supply	12 V DC	12 V DC	12 V DC	15 V DC
Memory	yes	yes	-	-
Network features	yes	-	-	-
Lock / gate control	yes/yes	yes/yes	yes/yes	yes/yes
Number of inputs	2× camera unit, 2× CCTV	2× camera unit, 2× CCTV	2× camera unit, 2× CCTV	1× camera unit
Monitor dimensions	175 × 118 × 25 mm	175 × 125 × 20 mm	233 × 23 × 160 mm	152 × 215 × 18 mm
Camera unit dimensions	142 × 44 × 21 mm	135 × 50 × 25 mm	64 × 46 × 145 mm	141 × 63 × 40 mm
View angle	120/160°	120/160°	80°	80°
Type of illumination	IR + IR CUT	IR + IR CUT	IR	IR
Water-resistant camera unit	yes	yes	yes	yes
Shock-resistant camera unit	yes	yes	yes	yes
Intercom	yes	yes	yes	-
Motion detection	yes	yes	-	-



	H4030	H4031	H4032
Order code			
Series	GoSmart		
Type	IP-09D	IP-09C	IP-15S
Camera resolution	1 920 × 1 080	1 920 × 1 080	1 920 × 1 080
Number of buttons	1	1	1
Power supply	Li-Ion battery 2× 18650	12 V DC	5 V DC/1 A, AC 12-24 V
Network features/WiFi	yes	yes	yes
Lock/gate control	yes/-	yes/-	-/-
Camera unit dimensions	149 × 63 × 46 mm	149 × 63 × 46 mm	145 × 57 × 41 mm
Camera viewing angle	110°	110°	130°
Type of illumination	IR + IR CUT	IR + IR CUT	IR
Water-resistant camera unit	yes	yes	yes
Shock-resistant camera unit	-	-	-
Motion detection	yes	yes	yes
Additional indoor bell	yes	yes	yes



Order code	E8010	E6016	E8466	E5111	E6018	E8670	E0387
Version	wireless	wireless	wireless	wireless	wireless	wireless	wireless
Clock	DCF (radio controlled clock)	controlled by DCF signal	controlled by DCF signal	controlled by DCF signal	controlled by DCF signal	controlled by DCF signal	controlled by DCF signal
Display backlight	yes	yes	yes	yes	yes	yes	yes
Wall-mounted	-	yes	-	yes	yes	yes	yes
Electronic panel backlight	yes	yes	-	yes	yes	yes	yes
Time zones	yes	yes	-	yes	yes	yes	yes
Projection	-	-	time and temperature projection	-	-	-	-
Date	yes	yes	yes	yes	yes	yes	yes
Calendar	yes	yes	yes	yes	yes	yes	yes
Alarm clock	yes	yes, 2x	yes, 2x	yes, 2x	yes, 2x	yes	yes
Outside temperature	-50 °C up to +70 °C, to 0,1 °C	-30 °C up +60 °C, to 0,1 °C	-20 °C up +60 °C, to 0,1 °C	-40 °C up +70 °C, to 0,1 °C	-50 °C up +70 °C, to 0,1 °C	-30 °C up +60 °C, to 0,1 °C	-40 °C up +60 °C, to 0,1 °C
Inside temperature	-2 °C up to +50 °C, to 0,1 °C	-10 °C up +50 °C, to 0,1 °C	-5 °C up +50 °C, to 0,1 °C	-10 °C up +50 °C, to 0,1 °C	-10 °C up +50 °C, to 0,1 °C	-10 °C up +50 °C, to 0,1 °C	-10 °C up +50 °C, to 0,1 °C
Outside humidity	20 % up to 95 % RV, to 1 %	1 % up 99 % RV, to 1 %	-	20 % up 95 % RV, to 1 %	1 % up 99 % RV, to 1 %	10 % up 99 % RV, to 1 %	1 % up 99 % RV, to 1 %
Inside humidity	20 % up to 95 % RV, to 1 %	1 % up 99 % RV, to 1 %	-	1 % up 99 % RV, to 1 %	1 % up 99 % RV, to 1 %	10 % up 99 % RV, to 1 %	1 % up 99 % RV, to 1 %
Minimum and maximum temperature	yes	yes	yes	yes	yes	yes	yes
Weather forecast	yes	yes	yes	yes	yes	yes	yes
Temperature warning	yes	yes	-	-	yes	yes	yes
Temperature/pressure trend	yes/yes	yes/yes	yes/-	yes/yes	yes/yes	yes/-	yes/yes
Barometer/precipitation gauge/anemometer	yes/-/-	yes/yes/yes	-/-/-	yes/-/-	yes/-/-	yes/yes/-	yes/-/-
Altitude correction	-	yes	-	-	yes	-	-
Phases of the moon	yes	yes	-	yes	yes	-	yes
Sensor range	up to 100 m	up 100 m	up 30 m	up 50 m	up 100 m	up 50 m	up 80 m
Optional additional sensor	up to 3 sensors (E00387, E05018)	up to 3 temperature and humidity sensors (E06018), 1 anemometer sensor (E06016)	up to 3 sensors (E08400)	up to 3 sensors (E05018)	up to 3 sensors (E06018)	-	up to 3 sensors (E00387)
Wire probe for sensor	-	-	-	yes	-	-	-
Sensor's power supply	2x 1,5 V AAA (not included)	4x 1,5 V AA (not included)	2x 1,5 V AA (not included)	2x 1,5 V AAA (not included)	2x 1,5 V AAA (not included)	2x 1,5 V AA (not included)	2x 1,5 V AA (not included)
Station's power supply	2x 1,5 V AA (not included)	3x 1,5 V AAA (not included)	1x CR2032 (included)	3x 1,5 V AAA (not included)	3x 1,5 V AAA (not included)	3x 1,5 V AAA (not included)	3x 1,5 V AA (not included)
Network adapter	yes, USB-C 9 V DC/2 000 mA, 1,5 m (included)	yes, 5 V DC/300 mA (included)	yes, 4,5 V DC/300 mA (included)	yes, 5 V DC/600 mA (included)	yes, 5 V DC/300 mA (included)	yes, 5 V DC/1 000 mA (included)	yes, 5 V DC/1 200 mA (included)
Dimension of the main unit	133 x 125 x 110 mm	17 x 192 x 127 mm	56 x 163 x 80 mm	26 x 197 x 125 mm	17 x 192 x 127 mm	29 x 205 x 127 mm	30 x 200 x 130 mm
Sensor's dimension	40 x 26 x 104 mm	250 x 160 x 100 mm	35 x 65 x 100 mm	21 x 60 x 100 mm	15 x 62 x 100 mm	117 x 117 x 164 mm	20 x 38 x 100 mm
Display size	110 x 73 mm	168 x 93 mm	102 x 42 mm	164 x 90 mm	168 x 93 mm	169 x 94 mm	168 x 91 mm



Obecné číslo	E8647	E3070	E3003	E0352	E5080	E0117N
Provedení	wireless	wireless	wireless	wireless	wireless	wire
Hodiny	yes, quartz	controlled by DCF signal	controlled by DCF signal	controlled by DCF signal	controlled by DCF signal	yes, quartz
Podsvícení displeje	yes	yes	yes	-	yes	-
Možnost pověšení na zeď	yes	-	-	yes	yes	-
Elektronické plošné podsvícení	yes	-	-	-	yes	-
Časová pásma	-	yes	yes	yes	yes	-
Projekce	-	-	-	-	-	-
Datum	-	yes	yes	yes	yes	yes
Kalendář	-	yes	yes	yes	yes	yes
Budík	yes	yes	yes	yes	yes, 2x	yes
Venkovní teplota	-50 °C up +70 °C, to 0,1 °C	-30 °C up +60 °C, to 0,1 °C	-50 °C up +70 °C, to 0,1 °C	-40 °C up +60 °C, to 0,1 °C	-40 °C up +70 °C, to 0,1 °C	-50 °C up +70 °C, to 0,1 °C
Vnitřní teplota	-10 °C up +50 °C, to 0,1 °C	0 °C up +50 °C, to 0,1 °C	-10 °C up +50 °C, to 0,1 °C	-10 °C up +50 °C, to 0,1 °C	-10 °C up +50 °C, to 0,1 °C	-10 °C up +50 °C, to 0,1 °C
Venkovní vlhkost	20 % up 95 % RV, to 1 %	-	20 % up 95 %, to 1 %	20 % up 95 % RV, to 1 %	20 % up 95 % RV, to 1 %	-
Vnitřní vlhkost	20 % up 95 % RV, to 1 %	20 % up 90 % RV, to 1 %	20 % up 95 %, to 1 %	1 % up 99 % RV, to 1 %	1 % up 99 % RV, to 1 %	20 % up 95 % RV, to 1 %
Min. a max. teplota	yes	-	yes	yes	yes	yes
Předpověď počasí	yes	yes	yes	yes	yes	yes
Teplotní výstraha	-	-	yes	-	-	-
Trend teploty/tlaku	-/-	yes/-	yes/-	yes/-	yes/yes	-/-
Barometr/srážkoměr/anemometr	-/-/-	-/-/-	-/-/-	-/-/-	yes/-/-	-/-/-
Korekce nadmořské výšky	-	-	-	-	yes	-
Fáze měsíce	-	yes	yes	yes	-	yes
Dosah čidla	up 50 m	up 30 m	up 30 m	up 30 m	up 30 m	-
Možné další čidlo	-	up to 3 sensors (E03070)	up to 3 sensors (E05018)	up to 3 sensors (E05018)	up to 3 sensors (E05018)	-
Drátová sonda k čidlu	-	-	-	-	yes	1,9 m
Napájení čidla	2x 1,5 V AAA (not included)	2x 1,5 V AAA (not included)	2x 1,5 V AAA (not included)	2x 1,5 V AA (not included)	2x 1,5 V AAA (not included)	-
Napájení stanice	2x 1,5 V AAA (not included)	3x 1,5 V AAA (not included)	2x 1,5 V AA (not included)	2x 1,5 V AAA (not included)	3x 1,5 V AA (not included)	2x LR1130 (included)
Sítový adaptér	yes, micro USB 5 V/1 A (not included)	-	-	-	-	-
Rozměr hlavní jednotky	20 × 85 × 96 mm	52 × 139 × 100 mm	50 × 120 × 180 mm	23 × 76 × 126 mm	27 × 130 × 130 mm	16 × 70 × 109 mm
Rozměr čidla	25 × 50 × 95 mm	24 × 44 × 100 mm	23 × 60 × 92 mm	21 × 38 × 100 mm	21 × 60 × 100 mm	-
Velikost displeje	65 × 76 mm	111 × 61 mm	80 × 120 mm	50 × 81 mm	105 × 105 mm	45 × 79 mm



Order code	P19223	P19224	P19222	P08215	P19733	P192250	P19220
Inclusion	NEOPRENE CABLE FOR MODERATE MECHANICAL LOAD, OIL-RESISTANT						
Warranty	5 years				2 years		
Conductor	H05VV-F 3 G				H07RN-F5G		H07RN-F 3 G
Conductor diameter	1,5 mm <sup>2</sup>	2,5 mm <sup>2</sup>	1,5 mm <sup>2</sup>	1,5 mm <sup>2</sup>	2,5 mm <sup>2</sup>	1,5 mm <sup>2</sup>	2,5 mm <sup>2</sup>
Maximum reeled load	4,35 A max./1 000 W	5,2 A max./1 200 W	4,35 A max./1 000 W	4,35 A max./1 000 W	230 V~: 6,52 A max./1 500 W; 400 V~: 6,25 A max./2 500 W	230 V~: 4,35 A max./1 000 W; 400 V~: 6,25 A max./2 500 W	6,52 A max./1 500 W
Maximum unreeled load	16 A max./3 680 W	16 A max./3 680 W	16 A max./3 680 W	13,04 A max./3 000 W	230 V~: 15,22 A max./3 500 W; 400 V~: 16 A max./6 400 W	230 V~: 13 A max./3 000 W; 400 V~: 12,5 A max./5 000 W	15,22 A max./3 500 W
Length	50 m	40 m	25 m	15 m	33 m	25 m	50 m
Metal body	yes	yes	yes	yes	-	-	-
Suitable for construction sites	yes	yes	yes	yes	yes	yes	yes
Indoor use	yes	yes	yes	yes	yes	yes	yes
Temperature range for cable use	from -25°C to +60°C						
Guide loop for easy cable reeling	yes	yes	yes	yes	-	-	-
Outdoor use	yes   IP44						
LED light	-	-	-	20 W/1 600 lm	-	-	-



Order code	P08250	P08225	P19625	P19221
Inclusion	RUBBER CABLE FOR STANDARD MECHANICAL STRESS			
Warranty	2 years			
Conductor	H05RR-F 3 G			
Conductor diameter	1,5 mm <sup>2</sup>		2,5 mm <sup>2</sup>	
Maximum reeled load	4,8 A max./1 100 W	4,8 A max./1 100 W	6 A max./1 600 W	6,52 A max./1 500 W
Maximum unreeled load	16 A max./3 680 W	16 A max./3 680 W	16 A max./3 680 W	15,22 A max./3 500 W
Length	50 m	25 m	25 m	50 m
Metal body	-	-	-	-
Suitable for construction sites	-	-	-	-
Indoor use	yes	yes	yes	yes
Temperature range for cable use	from -25°C to +60°C			
Guide loop for easy cable reeling	-	-	-	-
Outdoor use	yes   IP44			
LED light	-	-	-	-





Order code	<b>P08625W</b>		<b>P08650W</b>		<b>P08620W</b>	
Inclusion	SILICONE CABLE FOR MODERATE MECHANICAL LOADS, ANTI-FREEZE					
Warranty	3 years					
Conductor	AT-N05V3V3-F3G					
Conductor diameter	1,5 mm <sup>2</sup>					
Maximum reeled load	4,8 A max./1 100 W	4,8 A max./1 100 W	4,8 A max./1 100 W	4,8 A max./1 100 W	4,35 A max./1 000 W	4,35 A max./1 000 W
Maximum unreeled load	16 A max./3 680 W	16 A max./3 680 W	16 A max./3 680 W	16 A max./3 680 W	13,04 A max./3 000 W	13,04 A max./3 000 W
Length	25 m	50 m	50 m	50 m	20 m	20 m
Metal body	-	-	-	-	-	-
Suitable for construction sites	yes					
Indoor use	yes					
Temperature range for cable use	from -35 °C to 60 °C					
Guide loop for easy cable reeling	yes					
Outdoor use	yes   IP44					
LED light	-	-	-	-	yes	yes
Other functions	-	-	-	-	-	2x USB-A output







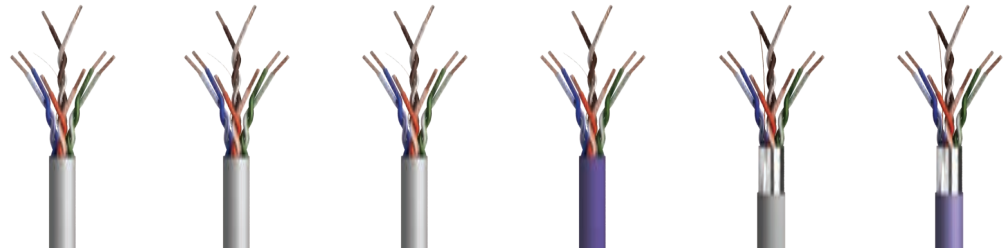

Order code	<b>P19427</b>		<b>P092501</b>		<b>P092251</b>		<b>P09250</b>		<b>P09225</b>		<b>P09240</b>	
Inclusion	PVC CABLE FOR STANDARD MECHANICAL STRESS											
Warranty	2 years											
Conductor	H05VV-F 3 G											
Conductor diameter	1,5 mm <sup>2</sup>											
Maximum reeled load	4,35 A max./1 000 W	4,8 A max./1 100 W	4,8 A max./1 100 W	4,8 A max./1 100 W	4,8 A max./1 100 W	4,8 A max./1 100 W	4,8 A max./1 100 W	4,8 A max./1 100 W	4,8 A max./1 100 W	4,8 A max./1 100 W	4,8 A max./1 100 W	4,8 A max./1 100 W
Maximum unreeled load	13 A max./3 000 W	16 A max./3 680 W	16 A max./3 680 W	16 A max./3 680 W	16 A max./3 680 W	16 A max./3 680 W	16 A max./3 680 W	16 A max./3 680 W	16 A max./3 680 W	16 A max./3 680 W	16 A max./3 680 W	16 A max./3 680 W
Length	25 m	50 m	25 m	50 m	25 m	50 m	25 m	50 m	25 m	40 m	40 m	40 m
Temperature range for cable use	from 4 °C to 60 °C											
Guide loop for easy cable reeling	-	yes	yes	yes	yes	yes	yes	yes	yes	yes	yes	yes
Outdoor use	-											







Order code	<b>P09240M</b>		<b>P09225M</b>		<b>P09220</b>		<b>P19515</b>		<b>P19510</b>	
Inclusion	PVC CABLE FOR STANDARD MECHANICAL STRESS									
Warranty	2 years									
Conductor	H05VV-F 3 G									
Conductor diameter	2,5 mm <sup>2</sup>					1,0 mm <sup>2</sup>				
Maximum reeled load	6 A max./1 380 W	6 A max./1 600 W	6 A max./1 600 W	6 A max./1 600 W	6 A max./1 600 W	4,8 A max./1 100 W	4 A max./920 W	4 A max./920 W	4 A max./920 W	4 A max./920 W
Maximum unreeled load	16 A max./3 600 W	16 A max./3 600 W	16 A max./3 600 W	16 A max./3 600 W	16 A max./3 600 W	10 A max./2 300 W	10 A max./2 300 W	10 A max./2 300 W	10 A max./2 300 W	10 A max./2 300 W
Length	40 m	25 m	25 m	25 m	25 m	20 m	15 m	15 m	10 m	10 m
Temperature range for cable use	from 4 °C to 60 °C									
Guide loop for easy cable reeling	-	-	-	-	-	yes	yes	yes	yes	yes
Outdoor use	-									

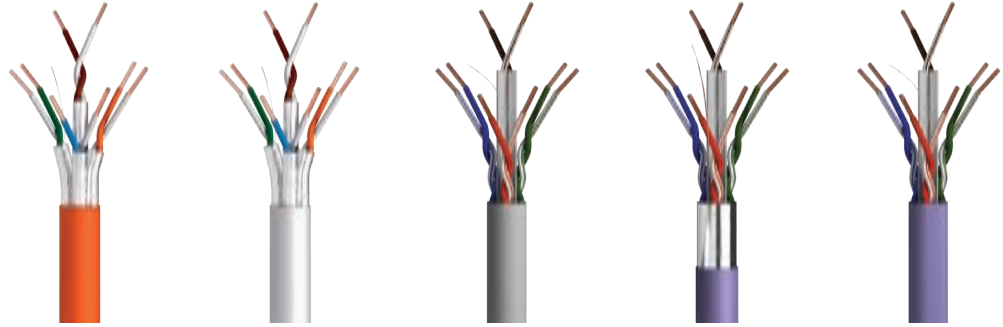

Order code	S9128	S9134	S9121	S9129	S9221	S9222
Type	UTP CAT 5E	UTP CAT 5E	UTP CAT 5E	UTP CAT 5E	F/UTP CAT 5E	F/UTP CAT 5E
<b>DESIGN PARAMETERS</b>						
Twisted pair	4×	4×	4×	4×	4×	4×
Number of wires	4× 2	4× 2	4× 2	4× 2	4× 2 + 1	4× 2 + 1
Shielding	-	-	-	-	aluminium/PET foils	aluminium/PET foils
Foil	-	-	-	-	7/12 – 18 mm	7/12 – 18 mm
Internal conductor	copper-clad aluminium (CCA)	copper wire	copper wire	copper wire	copper wire	copper wire
AWG	24	24	24	24	24	24
Diameter of conductors (mm)	0,51	0,45	0,48	0,48	0,48	0,48
Shielding of conductors	HDPE	HDPE	HDPE	HDPE	HDPE	HDPE
Average thickness (mm)	0,22	0,22	0,22	0,22	0,22	0,22
Strength member	nylon 150D	nylon 150D	nylon 150D	nylon 150D	CuSn wire 0,4 mm	CuSn wire 0,4 mm
Cable jacket	PVC	PVC	PVC	LSOH (LSZH)	PVC	LSOH (LSZH)
Jacket thickness (mm)	1,1	1,1	1,1	1,1	1,1	1,1
Diameter of cable jacket (mm)	5,2	5	5,2	5,2	6	6
Colour	grey	grey	grey	purple	grey	purple
<b>PACKAGING</b>						
Material	 305 m/paper box 5-layer cardboard with print	 305 m/paper box 5-layer cardboard with print	 305 m/paper box 5-layer cardboard with print	 305 m/paper box 5-layer cardboard with print	 305 m/paper box 5-layer cardboard with print	 305 m/paper box 5-layer cardboard with print
<b>MECHANICAL PROPERTIES</b>						
Max. DC insulation resistance	94,8	94,8	94,8	94,8	94,8	94,8
Operating temperature	60	60	60	60	60	60
<b>EU DIRECTIVE</b>						
EU Directive 2011/65	RoHS	RoHS	RoHS	RoHS	RoHS	RoHS
EU Directive 305/2011	CPR	CPR	CPR	CPR	CPR	CPR
<b>MEETS HARMONISED STANDARDS</b>						
	ČSN EN 50173-1 ed. 4:2019   ANSI/EIA/TIA 568A, 568B   ISO/IEC 11801   ČSN EN 50575:2015 A1:2017	ČSN EN 50173-1 ed. 4:2019   ANSI/EIA/TIA 568A, 568B   ISO/IEC 11801   ČSN EN 50575:2015 A1:2017	ČSN EN 50173-1 ed. 4:2019   ANSI/EIA/TIA 568A, 568B   ISO/IEC 11801   ČSN EN 50575:2015 A1:2017	ANSI/EIA/TIA 568A, 568B   ISO/IEC 11801   IEC 60754-2   ČSN EN 50173-1 ed. 4:2019   ČSN EN 50575:2015 A1:2017   ČSN EN 60754-1:2015   ČSN EN 60754-2:2015   ČSN EN 60754-1:2015   ČSN EN 60754-2:2015   IEC/ČSN EN 60332-1-2 / IEC/ČSN EN 61034-2	ČSN EN 50173-1 ed. 4:2019   ANSI/EIA/TIA 568A, 568B   ISO/IEC 11801   ČSN EN 50575:2015 A1:2017	ANSI/EIA/TIA 568A, 568B   ISO/IEC 11801   ČSN EN 50173-1 ed. 4:2019   IEC 60754-2   ČSN EN 50575:2015 A1:2017   ČSN EN 60754-1:2015   ČSN EN 60754-2:2015   IEC/ČSN EN 60332-1-2   ČSN EN 60754-1:2015   IEC/ČSN EN 61034-2
<b>CPR CERTIFICATION</b>						
Euroclass fire rating	Eca	Eca	Eca	Dca-s2-d2-a1	Eca	Dca-s2-d2-a2
Hazardous substances	-	-	-	-	-	-



Order code	S9310	S9320	S9131	S9230	S9132
Type	STP CAT6A	FFTP CAT6A	UTP CAT 6	F/UTP CAT 6	UTP CAT 6
<b>DESIGN PARAMETERS</b>					
Twisted pair	4×	4×	4×	4×	4×
Number of wires	4× 2 + 1	4× 2 + 1	4× 2	4× 2 + 1	4× 2
Shielding	aluminium/PET foils	aluminium/PET foils	-	aluminium/PET foils	-
Foil	7/12 - 18 mm	7/12 - 18 mm	-	7/12 - 18 mm	-
Internal conductor	copper wire	copper wire	copper wire	copper wire	copper wire
AWG	23	23	23	23	23
Diameter of conductors (mm)	0,56	0,56	0,55	0,55	0,55
Shielding of conductors	HDPE	HDPE	HDPE	HDPE	HDPE
Average thickness (mm)	0,22	0,22	0,22	0,22	0,22
Strength member	nylon 150D	nylon 150D	nylon 150D	CuSn wire 0,4 mm	nylon 150D
Cable jacket	LSZH	LSZH	PVC	LSOH (LSZH)	LSOH (LSZH)
Jacket thickness (mm)	1,1	1,1	1,1	1,1	1,1
Diameter of cable jacket (mm)	7,6	7,6	6,3	6,3	6,3
Colour	orange	grey	grey	purple	purple
<b>PACKAGING</b>					
Material	 500 m/ wooden coil	 500 m/ wooden coil	 305 m/ paper box 5-layer cardboard with print	 500 m/ wooden coil	 305 m/ paper box 5-layer cardboard with print
<b>MECHANICAL PROPERTIES</b>					
Max. DC insulation resistance	94,8	94,8	94,8	94,8	94,8
Operating temperature	-20 °C to 60 °C	-20 °C to 60 °C	60	60	60
<b>EU DIRECTIVE</b>					
EU Directive 2011/65	RoHS	RoHS	RoHS	RoHS	RoHS
EU Directive 305/2011	CPR	CPR	CPR	CPR	CPR
<b>MEETS HARMONISED STANDARDS</b>					
	ANSI/EIA/TIA 568A, 568B   ISO/IEC 11801   ČSN EN 50173-1 ed. 4:2019   IEC 60754-2   ČSN EN 50575:2015 A1:2017   ČSN EN 60754-1:2015   ČSN EN 60754-2:2015   IEC/ČSN EN 60332-1-2   ČSN EN 60754-1:2015   ČSN EN 60754-2:2015   IEC/ČSN EN 61034-2	ANSI/EIA/TIA 568A, 568B   ISO/IEC 11801   ČSN EN 50173-1 ed. 4:2019   IEC 60754-2   ČSN EN 50575:2015 A1:2017   ČSN EN 60754-1:2015   ČSN EN 60754-2:2015   IEC/ČSN EN 60332-1-2   ČSN EN 60754-1:2015   ČSN EN 60754-2:2015   IEC/ČSN EN 61034-2	ČSN EN 50173-1 ed. 4:2019   IEC 61156-5 Ed. 2   ISO/IEC 11801 CLASS   ČSN EN 50288-6-1 ed. 2:2014   ANSI/EIA/TIA 568B.2-1 Cat 6   ČSN EN 50575:2015 A1:2017	ANSI/EIA/TIA 568A, 568B   ISO/IEC 11801   ČSN EN 50173-1 ed. 4:2019   IEC 60754-2   ČSN EN 50575:2015 A1:2017   ČSN EN 60754-1:2015   ČSN EN 60754-2:2015   IEC/ČSN EN 60332-1-2   ČSN EN 60754-1:2015   ČSN EN 60754-2:2015   IEC/ČSN EN 61034-2	ANSI/EIA/TIA 568A, 568B   ISO/IEC 11801   ČSN EN 50173-1 ed. 4:2019   IEC 60754-2   ČSN EN 60754-1:2015   ČSN EN 60754-2:2015   IEC/ČSN EN 60332-1-2   ČSN EN 60754-1:2015   ČSN EN 60754-2:2015   IEC/ČSN EN 61034-2   ČSN EN 50288-1 ed. 3:2014
<b>CPR CERTIFICATION</b>					
Euroclass fire rating	B2ca-s1-d1-a1	Dca-s1-d2-a1	Eca	Dca-s2-d2-a2	Dca-s2-d2-a2
Hazardous substances	-	-	-	-	-

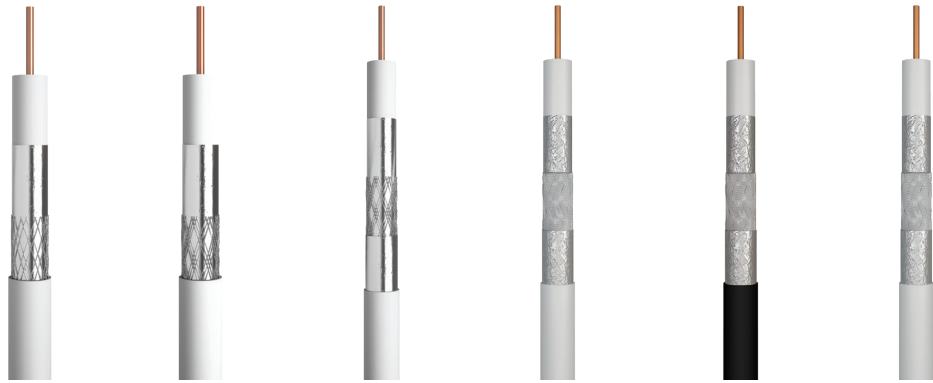

Order code		S5131   S5231S	S5141   S5241S	S5252   S5253	S5261   S5262   S5268	S5265   S5266	S5269   S5270
Type of coaxial cable		CB 50F	CB 100F	CB 500	CB 113	CB 113 UV	CB 113 LSZH
Type		75Ω					
Class		-	-	-	CLASS A+	CLASS A+	CLASS A+
<b>DESIGN PARAMETERS</b>							
Internal conductor Ø [mm], mat.		0,9 Cu	1,0 Cu	0,75 Cu	1,13 Cu	1,13 Cu	1,13 Cu
Dielectric Ø [mm], type		4,4 FPE	4,6 FPE	3,2 FPE	4,8 FPE	4,8 FPE	4,8 FPE
Shielding	I.foil	1× Al	1× Al	1× Al/PES	1× Al/PES	1× Al/PES	1× Al/PES
	Conductors Ø [mm]	CuSn 32× 0,12	CuSn 48× 0,12	CuSn 48× 0,12	CuSn 144× 0,12	CuSn 144× 0,12	CuSn 144× 0,12
	II.foils	-	-	Al/PES spiral	Al/PES spiral	Al/PES spiral	Al/PES spiral
Jacket Ø [mm]		6,3±0,2	6,5±0,2	5±0,2	7,05±0,2	7,05±0,2	7,05±0,2
Material		PVC	PVC	PVC	PVC	PVC – UV resistant	LSZH
Colour		white	white	white	white	black	white
<b>ELECTRICAL PARAMETERS</b>							
Impedance [Ω]		75±3					
Capacity [pF/m]		56	54	53	52	52,5	52
Shortening coefficient		0,81	0,82	0,85	0,85	0,84	0,85
Maximum attenuation at 20 °C [dB/100 m]	10 MHz	2,2	2	4,5	2,2	2,28	2,2
	100 MHz	7	7	10,5	5,8	5,8	5,8
	450 MHz	14,3	14,1	20,2	12,5	12,6	12,5
	650 MHz	17,8	17,5	24,1	15,3	15,1	15,3
	860 MHz	20,8	20,5	28	18,5	17,87	18,5
	1 000 MHz	21,8	21	29,1	19,3	19,5	19,3
	2 000 MHz	32	31	>35	29,5	28,02	29,5
Maximum return loss at 20 °C [dB]	10–300 MHz	25	25	25	30	31	-
	300–600 MHz	23	23	20	25	25	25
	600–900 MHz	20	20	18	23	23	23
Min. shielding effectiveness [dB]	10–800 MHz	75	75	75	>95	>95	>95
Max. DC resistance at 20 °C [Ω/km]	Inner core	29,3	23,7	41,5	18,5	25,7	18,5
	Outer core	57,2	38,2	48,5	38,5	45,9	38,5
Insulation resistance between cores at 20 °C* [MΩ/km]		500	500	1 000	1 000	500	1 000
<b>MECHANICAL PROPERTIES</b>							
Weight [kg/km]		39,5	40,5	26,5	41,5	43,5	43,5
Min. bending radius single/multiple [mm]		30/60	30/60	25/50	35/70	30/60	35/70
Operating temperature [°C]	Operating	-20 ~ +75					
	During installation	+5 ~ +60					
Packaging method	Length [m]	100   250	100   250	100   250	100   250   500	100   250	250   500
	Reel type	paper	paper	paper	paper   wood	paper	paper   wood
	Metrage marking	yes					
<b>RECOMMENDED CONNECTOR TYPES</b>							
Order code	F screw-on	K7331	K7331	K7321	K7351	K7351	K7351

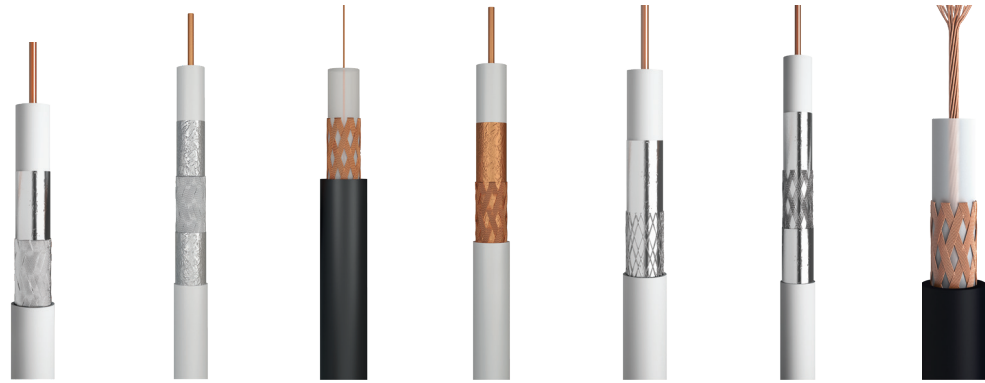

Order code	S5271   S5273	S5272	S5194	S5385	S5381   S5381E	S5382   S5383	S5213	
Type of coaxial cable	CB 21D	CB 115	RG59B/U	CB 125	CB 130	CB 135	RG58U	
Type	75Ω						50Ω	
Class	CLASS A	CLASS A	-	-	-	CLASS A	-	
<b>DESIGN PARAMETERS</b>								
Internal conductor Ø [mm], mat.	1,10 Cu	1,02 Cu	0,58 Cu	1,02 Cu	1,02 CCS	1,02 CCS	17× 0,19 CCA	
Dielectric Ø [mm], type	4,8 FPE	4,8 FPE	3,7 FPE	4,8 FPE	4,8 FPE	4,8 FPE	3 SPE	
Shielding	I.foil	1× Al/PET	-	1× CCA/PES	1× Al/PES	1× Al/PES	-	
	Conductors Ø [mm]	Al 128× 0,12	Al 96× 0,12	CCA 128× 0,12	CCA 64× 0,12	Al 32× 0,12	Al 64× 0,12	CCA 112× 0,12
	II.foils	-	Al/PET	-	-	-	Al/PES	-
Jacket Ø [mm]	6,8±0,2	6,8±0,2	6,05±0,2	6,8±0,2	6,8±0,2	6,8±0,2	5±0,2	
Material	PVC	PVC	PVC	PVC	PVC	PVC	PVC	
Colour	white	white	black	white	white	white	black	
<b>ELECTRICAL PARAMETERS</b>								
Impedance [Ω]	75±3						50±3	
Capacity [pF/m]	52	50	70	54	55	75	100	
Shortening coefficient	0,85	0,81	0,66	0,83	0,84	0,85	0,66	
Maximum attenuation at 20 °C [dB/100 m]	10 MHz	2,2	2,17	3	2,28	2,32	2,28	8,5
	100 MHz	4,2	7,35	9	7,1	7,4	7,2	14,2
	450 MHz	11,3	13,2	20	14,4	15,5	15	32,9
	650 MHz	14,8	17,42	28	17,6	18,2	18,3	47,2
	860 MHz	17,6	19,47	32	20,6	20,8	20,7	-
	1 000 MHz	18,4	19,8	-	21,3	22,5	21,9	-
	2 000 MHz	27,1	29,9	-	31,5	34	33,5	-
Maximum return loss at 20 °C [dB]	10-300 MHz	30	25	20	23	25	25	-
	300-600 MHz	25	23	16	20	23	23	18
	600-900 MHz	23	19	16	20	20	20	16
Min. shielding effectiveness [dB]	10-800 MHz	>110	>100	90	77	75	>110	65
Max. DC resistance at 20 °C [Ω/km]	Inner core	19,5	21	170	23,9	25,7	25,3	37,6
	Outer core	38,5	38	17	38,9	45,9	49,2	17,1
Insulation resistance between cores at 20 °C* [MΩ/km]	>500	500	>10 000	500	500	500	500	
<b>MECHANICAL PROPERTIES</b>								
Weight [kg/km]	41,5	41	55	40,5	40,5	40,5	40,5	
Min. bending radius single/multiple [mm]	35/70	30/60	25/50	30/60	30/60	30/60	25/50	
Operating temperature [°C]	Operating	-20 ~ +75						
	During installation	+5 ~ +60						
Packaging method	Length [m]	100   500	100	500	100	100	100   500	500
	Reel type	paper   wood	paper	paper   wood	paper	paper   PVC	paper   wood	wood
	Metrage marking	yes						
<b>RECOMMENDED CONNECTOR TYPES</b>								
Order code	F screw-on	K7351	K7351	K7331	K7351	K7331	K7331	-





	<b>J0701</b>	<b>J0703</b>	<b>J0704</b>
Order code	J0701	J0703	J0704
Use	indoor	indoor	indoor
Signal reception	FM/DAB/DVB-T/T2	DAB/DVB-T/T2	FM/DAB/DVB-T/T2
Suitable for receiving full HD broadcasts	yes	yes	yes
LTE filter	yes	yes	yes
5G filter	yes	yes	yes
Polarization	horizontal and vertical	horizontal and vertical	horizontal and vertical
Frequency bands	FM/VHF/DAB/UHF	VHF/UHF	FM/VHF/DAB/UHF
Frequency range	47-230 MHz, 470-698 MHz	174-230 MHz, 470-698 MHz	87.5-230 MHz, 470-698 MHz
Reception angle	360°	360°	360°
Power supply	DC USB 5 V/550 mA (included)	DC USB 5 V/550 mA (included)	DC USB 5 V/550 mA (included)
Connector type	IEC	IEC	IEC

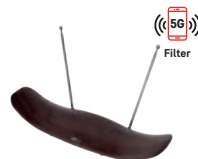

	<b>J0705</b>	<b>J0708</b>	<b>J0709</b>
Order code	J0705	J0708	J0709
Use	indoor	indoor	indoor
Signal reception	FM/DAB/DVB-T/T2	FM/DAB/DVB-T/T2	DAB/DVB-T/T2
Suitable for receiving full HD broadcasts	yes	yes	yes
LTE filter	yes	yes	yes
5G filter	yes	yes	yes
Polarization	horizontal and vertical	horizontal and vertical	horizontal and vertical
Frequency bands	FM/VHF/DAB/UHF	FM/VHF/DAB/UHF	VHF/UHF
Frequency range	87.5-230 MHz, 470-698 MHz	87.5-230 MHz, 470-698 MHz	174-230 MHz, 470-698 MHz
Reception angle	180°	360°	180°
Power supply	DC USB 5 V/550 mA (included)	USB 5 V/200 mA (included)	USB 5 V/200 mA (included)
Connector type	IEC	IEC	IEC



	<b>J0801</b>	<b>J0802</b>	<b>J0803</b>
Order code	J0801	J0802	J0803
Use	universal	indoor/outdoor	indoor/outdoor
Signal reception	DVB-T/T2	FM/DAB/DVB-T/T2	FM/DAB/DVB-T/T2
Suitable for receiving full HD broadcasts	yes	yes	yes
LTE filter	yes	yes	yes
5G filter	yes	yes	yes
Polarization	horizontal and vertical	horizontal and vertical	horizontal and vertical
Frequency bands	UHF	FM/VHF/DAB/UHF	FM/VHF/UHF
Frequency range	470-698 MHz	87.5-230 MHz, 470-698 MHz	47-698 MHz
Reception angle	90°	180°	360°
Power supply	DC USB 5 V/550 mA (included)	USB 5 V/200 mA (included)	USB 5 V/200 mA (included)
Connector type	F, IEC	IEC	IEC

**Village**



Order code	J0806	J0804	J0685
Use	outdoor	universal	indoor/outdoor
Signal reception	DVB-T/T2	DAB/DVB-T/T2	DVB-T/T2
Suitable for receiving full HD broadcasts	yes	yes	yes
LTE filter	yes	yes	yes
5G filter	yes	yes	yes
Polarization	horizontal or vertical	horizontal and vertical	horizontal and vertical
Frequency bands	UHF	VHF/DAB/UHF	UHF
Frequency range	470–698 MHz	174–230 MHz, 470–698 MHz	470–698 MHz
Reception angle	30°/40°	180°	30°/40°
Power supply	DC 5–12 V/100 mA (included)	DC USB 5 V/550 mA (included)	DC USB 5 V/550 mA (included)
Connector type	F	F, IEC	F, IEC

**Profi**

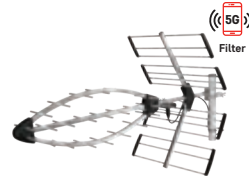
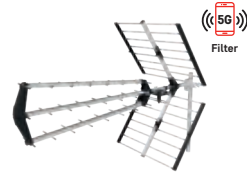

Order code	J0906	J0907	J0690	J0669
Use	outdoor YAGI	outdoor YAGI	outdoor	outdoor
Signal reception	DVB-T/T2	DVB-T/T2	DVB-T/T2	DVB-T/T2
Suitable for receiving full HD broadcasts	yes	yes	yes	yes
LTE filter	yes	yes	yes	yes
5G filter	yes	yes	yes	–
Polarization	horizontal and vertical	horizontal and vertical	horizontal and vertical	horizontal and vertical
Frequency bands	UHF	UHF	UHF	UHF
Frequency range	470–698 MHz	470–698 MHz	470–698 MHz	470–790 MHz
Reception angle	38°/80°	38°/80°	38°/80°	45°/40°
Power supply	not stated	not stated	passive	passive
Connector type	F connector	F connector	F connector	F connector



Order code	J0680	J0665	J0666
Use	outdoor	set containing antenna, preamplifier and power supply	set containing antenna, preamplifier and power supply
Signal reception	DVB-T/T2	DAB/DVB-T/T2	DAB/DVB-T/T2
Suitable for receiving full HD broadcasts	yes	yes	yes
LTE filter	yes	yes	yes
5G filter	–	–	–
Polarization	horizontal and vertical	horizontal and vertical	horizontal and vertical
Frequency bands	UHF	VHF/DAB/UHF	VHF/DAB/UHF
Frequency range	470–790 MHz	170–790 MHz	170–790 MHz
Reception angle	34°/26°	30°/40°	30°/40°
Power supply	passive	12 V/100 mA (included)	12 V/100 mA (included)
Connector type	F connector	F connector	F connector



Order code	M3620	M0305	M3216	M0230	M2092	M0391	M0320
Series	300			200			100
Type	MD-310	MD-310C	MD-300	MD-230	MD-220	MD-210	MD-110
Range selection	manual	automatic	automatic	manual	manual	manual	manual
AC voltage	200 – 300 V	2 – 600 V	2–600 V	2 – 600 V	2 – 600 V	200 – 300 V	200 – 300 V
DC voltage	200 mV – 300 V	200 mV – 600 V	200 mV – 600 V	200 mV – 600 V	200 mV – 600 V	200 mV – 300 V	200 mV – 300 V
AC current	–	–	200 $\mu$ A – 200 mA	2 mA – 10 A	2 mA – 10 A	–	–
DC current	20 mA – 10 A	2 – 600 A	200 $\mu$ A – 200 mA	2 mA – 10 A	2 mA – 10 A	20 $\mu$ A – 10 A	2 000 $\mu$ A – 200 mA
Electrical resistance	200 $\Omega$ – 2 M $\Omega$	200 $\Omega$ – 20 M $\Omega$	200 Ohm – 20 MOhm	200 $\Omega$ – 20 M $\Omega$	200 $\Omega$ – 20 M $\Omega$	200 $\Omega$ – 2 M $\Omega$	200 $\Omega$ – 2 M $\Omega$
Circuit continuity	yes	yes	yes	yes	yes	yes	–
Diode test	yes	yes	yes	yes	yes	yes	yes
Transistor test	–	–	–	yes	yes	–	–
Battery test	yes	–	–	–	–	–	yes
Temperature measurement	–	–	–	–	–	–	–
Touchless AC voltage detection	–	–	–	–	–	–	–
Product details	safe measuring tip connection technology	–	–	–	–	–	–



Order code	M0430	M0420	M3691	M0400
Series	400			
Type	MD-430	MD-420	MD-410	MD-410C
Range selection	automatic + manual	automatic	manual	automatic + manual
AC voltage	600 mV – 750 V	2 – 300 V	200 mV – 300 V	4 V – 600 V
DC voltage	600 mV – 1 000 V	200 $\mu$ A – 10 A (to 1 000 A)	200 mV – 300 V	400 mV – 600 V
AC current	600 $\mu$ A – 10 A	200 mV – 300 A	20 mA – 10 A	400 A
DC current	600 $\mu$ A – 10 A	200 $\mu$ A – 10 A (to 1 000 A)	20 mA – 10 A	400 A
Electrical resistance	600 Ohm – 60 MOhm	200 $\Omega$ – 20 M $\Omega$	200 $\Omega$ – 20 M $\Omega$	400 $\Omega$ – 40 M $\Omega$
Circuit continuity	yes	yes	yes	yes
Diode test	yes	yes	yes	yes
Transistor test	yes	yes	–	–
Battery test	–	–	yes	–
Temperature measurement	-40 $^{\circ}$ C to +300 $^{\circ}$ C	-20 $^{\circ}$ C to +1 000 $^{\circ}$ C	0 $^{\circ}$ C to +1 000 $^{\circ}$ C	-20 $^{\circ}$ C to +1 000 $^{\circ}$ C
Touchless AC voltage detection	–	–	yes	–
Product details	maximum value memory, measured value memory	–	safe measuring tip connection technology	–



Order code	M0071	M0012A	M0014A	M0003B	M0007A	M0048	M0018
Series	700	300		200		100	
Type	VT-710	VT-320	VT-310	VT-211	VT-150	VT-120	VT-110
AC voltage	6 – 690 V	12 – 690 V	110 – 400 V	6–400 V	70 – 1 000 V touchless	70 – 250 V touchless	70 – 250 V touchless
DC voltage	6 – 690 V	12 – 690 V	110 – 400 V	6–400 V		0 – 250 V touchless	0 – 250 V touchless
Indication	optical + acoustic	optical + acoustic	optical	optical	optical + acoustic	optical + acoustic	optical
Determination of polarity	yes	yes	yes	yes	–	yes	yes
Determination of phase sequence	yes	yes	yes	–	–	–	–
Circuit continuity	yes	yes	–	–	–	–	–

**Measuring tools**



Order code	M0501	M0502	M0503	N0322
Name	Multidetector	Laser distance meter	IR thermometer	Universal battery tester
Product details	detection of AC wiring, metal and wood	0,05 – 40 m, length, area, volume, Pythagoras, continuous measurement	optical characteristic 8:1, laser measurement, continuous measurement, memory, -50 °C to 380 °C	for batteries AAA, AA, C, D, 9 V, button



Order code	P56110T	P56160T	P56060T	P5603R	P5614
Thermostat type	wireless with OpenTherm communication	wireless with OpenTherm communication	wired with OpenTherm communication	wire	wireless
Control mode	heating and cooling system	heating and cooling system	heating and cooling system	heating and cooling system	heating and cooling system
Number of programs	6 programs + 3 customizable	1 customizable program and customizable temperature (6× per day)	1 customizable program and customizable temperature (6× per day)	customizable temperature	customizable temperature
Temperature setting type	6 temperature changes per day	6 temperature changes per day	6 temperature changes per day	manually	manually
Temperature setting	from 7 °C up to 30 °C, by 0.2 °C	from 5 °C up to 35 °C, by 0.5 °C	from 5 °C up to 35 °C, by 0.5 °C	from 5 °C up to 30 °C, by 1 °C	from 5 °C up to 35 °C, by 0.5 °C
Adjustable variance of temperature	0.1 °C, 0.2 °C, 0.5 °C, 1.0 °C	from 0.2 °C up to 2 °C, by 0.1 °C	from 0.2 °C up to 2 °C, by 0.1 °C	0.4 °C	±0.2 °C
ON/OFF function	yes	yes	yes	–	yes
Holiday mode	–	yes	yes	–	–
Switching	230 V AC and potential-free	230 V AC and potential-free	230 V AC and potential-free	230 V AC and potential-free	230 V AC and potential-free
Switching load	16 A resistive, 5 A inductive	10 A resistive, 4 A inductive	6 A resistive, 2 A inductive	6 A resistive, 2 A inductive	16 A resistive, 4 A inductive
Power supply	230 V AC (receiver)/2× 1.5 V AA (transmitter)	230 V AC (receiver)/2× 1.5 V AA (transmitter)	2× 1.5 V AA (included)	2× 1.5 V AA (included)	230 V AC (receiver)/2× 1.5 V AAA (transmitter)
Other features	OpenTherm & relay output, lock function, illuminated display, range 100 m	OpenTherm & relay output, lock function, illuminated display, range 100 m	OpenTherm & relay output, lock function, illuminated display	freeze protection	freeze protection, illuminated display, range 100 m



Order code	P5604	P5623	P5607	P5601UF	P5660FR
Thermostat type	wire	wireless	wire	wired for underfloor heating	socket
Control mode	heating and cooling system	heating system	heating and cooling system	heating system	heating and cooling system
Number of programs	customizable temperature	customizable	1 customizable program and customizable temperature (6× per day)	1 customizable program and customizable temperature (6× per day)	customizable temperature (6× per day)
Temperature setting type	manually	6 temperature changes per day	6 temperature changes per day	6 temperature changes per day	6 temperature changes per day
Temperature setting	from 5 °C up to 35 °C, by 0.5 °C	5 °C to 35 °C, resolution 0.5 °C	from 5 °C up to 35 °C, by 0.5 °C	from 5 °C up to 95 °C, by 0.5 °C	5 °C to 40 °C, resolution 0.5 °C
Adjustable variance of temperature	±0.2 °C	±0.3 °C	from 0.2 °C up to 2 °C, by 0.1 °C	from 1 °C up to 10 °C, by 1 °C	from 0.2 °C up to 2 °C, by 0.1 °C
ON/OFF function	–	yes	–	yes	yes
Holiday mode	–	yes	–	–	–
Switching	230 V AC and potential-free	230 V AC and potential-free	230 V AC and potential-free	voltage 230 V AC, 50 Hz	230 V AC and potential-free
Switching load	8 A resistively, 2 A inductively	16 A resistive, 4 A inductive	8 A resistively, 2 A inductively	16 A resistive	16 A resistive, 4 A inductive
Power supply	2× 1.5 V AAA (included)	230 V AC (receiver)/ 5 V (transmitter)	2× 1.5 V AAA (included)	230 V AC	230 V AC
Other features	freeze protection, illuminated display	control via mobile app, Wi-Fi connection; master lock; freeze protection, range 100 m	freeze protection, illuminated display	freeze protection	freeze protection, temperature calibration, timer (countdown, summer/winter time)





Order code	P56201	P56211	P56201UF	P5630S
Thermostat type	wire	wireless	wired for underfloor heating	SMART, programmable thermo knob
Control mode	heating and cooling system	heating and cooling system	heating system	heating system
Number of programs	customizable temperature (6× per day)	customizable temperature (6× per day)	customizable temperature (6× per day)	1 customizable program and customizable temperature (6× per day)
Temperature setting type	6 temperature changes per day	6 temperature changes per day	6 temperature changes per day	6 temperature changes per day
Temperature setting	from 5 °C up to 35 °C, by 0.5 °C	from 5 °C up to 35 °C, by 0.5 °C	from 1 °C up to 70 °C, by 0.5 °C	1 °C to 70 °C, resolution 0.5 °C
Adjustable variance of temperature	0.2 °C to 2 °C (resolution 0.1 °C)	0.2 °C to 2 °C (resolution 0.1 °C)	internal sensor: 0.5 °C to 2.5 °C, resolution 0.5 °C; underfloor sensor: 1 °C to 9 °C, resolution 1 °C	from 0.5 °C up to 1.5 °C, by 0.5 °C
ON/OFF function	yes	yes	yes	-
Holiday mode	yes	yes	yes	yes
Switching	voltage 230 V AC, 50 Hz	230 V AC and potential-free	voltage 230 V AC, 50 Hz	-
Switching load	6 A resistive, 2 A inductive	16 A resistive, 4 A inductive	16 A resistive	-
Power supply	230 V AC	230 V AC (receiver)/5 V (transmitter)	230 V AC	2× 1.5 V AA (included)
Other features	freeze protection, temperature calibration, switching based on GPS location	freeze protection, temperature calibration, switching based on GPS location	freeze protection, temperature calibration, switching based on GPS location	freeze protection, temperature calibration, child lock, switching based on GPS location
Matrix	-	-	-	M30 × 1.5 mm
Included adaptors	-	-	-	Danfoss RA, RAV, RAVL



Order code	P5685	P5686	P5683	P5684	P5681	P5682
Thermostat type	wire, flow thermostat	wire, flow thermostat	wire, flow thermostat	wire, capillary sensor thermostat	wire, flow thermostat	wire, capillary sensor thermostat
Control mode	heating and cooling system	heating and cooling system	heating and cooling system	heating and cooling system	heating and cooling system	heating and cooling system
Number of programs	-	-	-	-	-	-
Temperature setting type	manually	manually	manually	manually	manually	manually
Temperature setting	0 °C to 90 °C, resolution 5 °C	from 5 °C up to 80 °C, by 0.1 °C	from 5 °C up to 80 °C, by 0.1 °C	from 5 °C up to 90 °C, by 0.1 °C	0 °C to 90 °C, resolution 5 °C	0 °C to 90 °C, resolution 5 °C
Adjustable variance of temperature	-	from 0.1 °C up to 15 °C, by 0.1 °C	from 0.1 °C up to 15 °C, by 0.1 °C	from 0.1 °C up to 15 °C, by 0.1 °C	-	-
ON/OFF function	-	yes	yes	yes	-	-
Holiday mode	-	-	-	-	-	-
Switching	voltage 230 V AC, 50 Hz	voltage 230 V AC, 50 Hz	voltage 230 V AC, 50 Hz	voltage 230 V AC, 50 Hz	voltage 230 V AC, 50 Hz	voltage 230 V AC, 50 Hz
Switching load	16 A resistive, 4 A inductive	5 A resistively, 1.5 A inductively	5 A resistively, 1.5 A inductively	5 A resistively, 1.5 A inductively	16 A resistive, 4 A inductive	16 A resistive, 4 A inductive
Power supply	230 V, 400 V AC	230 V AC	230 V AC	230 V AC	230 V, 400 V AC	230 V, 400 V AC
Other features	-	-	display with set/current temperature, LED indication of thermostat activation, ON/OFF function	display with set/current temperature, LED indication of thermostat activation, ON/OFF function	-	-



## A60 SHAPE

Old model			New model			
Order code	Parameters	Energy class	Order code	Parameters	Energy class	EAN
ZQ5142	8,5 W (60 W) / 806 lm / E27 / CW	F	ZQ5E44	7 W (60 W) / 806 lm / E27 / CW	E	8 592920 126509
ZQ5152	10,7 W (75 W) / 1 060 lm / E27 / CW	F	ZQ5E54	9,5 W (75 W) / 1 055 lm / E27 / CW	E	8 592920 126592
ZQ5162	13,2 W (100 W) / 1 521 lm / E27 / CW	E	ZQ5E64	13 W (100 W) / 1 521 lm / E27 / CW	E	8 592920 126684
ZQ5130	7,3 W (50 W) / 645 lm / E27 / WW	F	ZQ5E31	5,8 W (50 W) / 645 lm / E27 / WW	E	8 592920 126387
ZQ5140	8,5 W (60 W) / 806 lm / E27 / WW	F	ZQ5E41	7 W (60 W) / 806 lm / E27 / WW	E	8 592920 126448
ZQ5140.3	8,5 W (60 W) / 806 lm / E27 / WW / 3PC	F	ZQ5E41.3	7 W (60 W) / 806 lm / E27 / WW / 3PC	E	8 592920 126714
ZQ5150	10,7 W (75 W) / 1 060 lm / E27 / WW	F	ZQ5E51	9,5 W (75 W) / 1 055 lm / E27 / WW	E	8 592920 126530
ZQ5150.3	10,7 W (75 W) / 1 060 lm / E27 / WW / 3PC	F	ZQ5E51.3	9,5 W (75 W) / 1 055 lm / E27 / WW / 3PC	E	8 592920 126837
ZQ5160	13,2 W (100 W) / 1 521 lm / E27 / WW	E	ZQ5E61	13 W (100 W) / 1 521 lm / E27 / WW	E	8 592920 126622
ZQ5160.3	13,2 W (100 W) / 1 521 lm / E27 / WW / 3PC	E	ZQ5E61.3	13 W (100 W) / 1 521 lm / E27 / WW / 3PC	E	8 592920 126899
ZQ5120	5,2 W (40 W) / 470 lm / E27 / WW	F	ZQ5E21	4 W (40 W) / 470 lm / E27 / WW	E	8 592920 126325
ZQ5131	7,3 W (50 W) / 645 lm / E27 / NW	F	ZQ5E33	5,8 W (50 W) / 645 lm / E27 / NW	E	8 592920 126417
ZQ5141	8,5 W (60 W) / 806 lm / E27 / NW	F	ZQ5E43	7 W (60 W) / 806 lm / E27 / NW	E	8 592920 126479
ZQ5141.3	8,5 W (60 W) / 806 lm / E27 / NW / 3PC	F	ZQ5E43.3	7 W (60 W) / 806 lm / E27 / NW / 3PC	E	8 592920 126776
ZQ5151	10,7 W (75 W) / 1 060 lm / E27 / NW	F	ZQ5E53	9,5 W (75 W) / 1 055 lm / E27 / NW	E	8 592920 126561
ZQ5151.3	10,7 W (75 W) / 1 060 lm / E27 / NW / 3PC	F	ZQ5E53.3	9,5 W (75 W) / 1 055 lm / E27 / NW / 3PC	E	8 592920 126868
ZQ5161	13,2 W (100 W) / 1 521 lm / E27 / NW	E	ZQ5E63	13 W (100 W) / 1 521 lm / E27 / NW	E	8 592920 126653
ZQ5161.3	13,2 W (100 W) / 1 521 lm / E27 / NW / 3PC	F	ZQ5E63.3	13 W (100 W) / 1 521 lm / E27 / NW / 3PC	E	8 592920 126929
ZQ5121	5,2 W (40 W) / 470 lm / E27 / NW	F	ZQ5E23	4 W (40 W) / 470 lm / E27 / NW	E	8 592920 126356
-	-	-	ZL4206	3× DIMM / 10,5 W (75 W) / 1 060 lm / WW	F	8 592920 044360

## A67 SHAPE

## A70 SHAPE

Old model			New model			
Order code	Parameters	Energy class	Order code	Parameters	Energy class	EAN
ZQ5173	17 W (120 W) / 1 900 lm / E27 / WW	E	ZQ5E71	16 W (120 W) / 1 901 lm / E27 / WW	E	8 592920 126950
ZQ5174	17 W (120 W) / 1 900 lm / E27 / NW	E	ZQ5E73	16 W (120 W) / 1 901 lm / E27 / NW	E	8 592920 126981
ZQ5175	17 W (120 W) / 1 900 lm / E27 / CW	E	ZQ5E74	16 W (120 W) / 1 901 lm / E27 / CW	E	8 592920 127018

## A67 SHAPE

## A80 SHAPE

Old model			New model			
Order code	Parameters	Energy class	Order code	Parameters	Energy class	EAN
ZQ5183	19 W (150 W) / 2 452 lm / E27 / WW	E	ZQ5E81	20 W (150 W) / 2 452 lm / E27 / WW	E	8 592920 127049
ZQ5184	19 W (150 W) / 2 452 lm / E27 / NW	E	ZQ5E83	20 W (150 W) / 2 452 lm / E27 / NW	E	8 592920 127070
ZQ5185	19 W (150 W) / 2 452 lm / E27 / CW	E	ZQ5E84	20 W (150 W) / 2 452 lm / E27 / CW	E	8 592920 127100

## A95 SHAPE

Old model			New model			
Order code	Parameters	Energy class	Order code	Parameters	Energy class	EAN
-	-	-	ZQ5E91	28 W (200 W) / 3 452 lm / E27 / WW	E	8 592920 130803
-	-	-	ZQ5E93	28 W (200 W) / 3 452 lm / E27 / NW	E	8 592920 130834

## CANDLE SHAPE

Old model			New model			
Order code	Parameters	Energy class	Order code	Parameters	Energy class	EAN
ZQ3222	5 W (40 W) / 470 lm / E14 / CW	F	ZQ3E24	4,2 W (40 W) / 470 lm / E14 / CW	E	8 592920 127254
ZQ3232	7,3 W (60 W) / 806 lm / E14 / CW	E	ZQ3E44	6,5 W (60 W) / 806 lm / E14 / CW	E	8 592920 127346
ZQ3210	4,1 W (32 W) / 350 lm / E14 / WW	F	ZQ3D11	2,5 W (32 W) / 350 lm / E14 / WW	D	8 592920 127131
ZQ3220	5 W (40 W) / 470 lm / E14 / WW	F	ZQ3E21	4,2 W (40 W) / 470 lm / E14 / WW	E	8 592920 127193
ZQ3220.3	5 W (40 W) / 470 lm / E14 / WW / 3PC	F	ZQ3E21.3	4,2 W (40 W) / 470 lm / E14 / WW / 3PC	E	8 592920 127490
ZQ3230	7,3 W (60 W) / 806 lm / E14 / WW	E	ZQ3E41	6,5 W (60 W) / 806 lm / E14 / WW	E	8 592920 127285
ZQ3211	4,1 W (32 W) / 350 lm / E14 / NW	F	ZQ3D13	2,5 W (32 W) / 350 lm / E14 / NW	D	8 592920 127162
ZQ3221	5 W (40 W) / 470 lm / E14 / NW	F	ZQ3E23	4,2 W (40 W) / 470 lm / E14 / NW	E	8 592920 127223
ZQ3221.3	5 W (40 W) / 470 lm / E14 / NW / 3PC	F	ZQ3E23.3	4,2 W (40 W) / 470 lm / E14 / NW / 3PC	E	8 592920 127520
ZQ3231	7,3 W (60 W) / 806 lm / E14 / NW	E	ZQ3E43	6,5 W (60 W) / 806 lm / E14 / NW	E	8 592920 127315
ZQ3110	4,1 W (32 W) / 350 lm / E27 / WW	F	ZQ4D11	2,5 W (32 W) / 350 lm / E27 / WW	D	8 592920 127377
ZQ3120	4,9 W (40 W) / 470 lm / E27 / WW	F	ZQ4E21	4,2 W (40 W) / 470 lm / E27 / WW	E	8 592920 127438
ZQ3111	4,1 W (32 W) / 350 lm / E27 / NW	F	ZQ4D13	2,5 W (32 W) / 350 lm / E27 / NW	D	8 592920 127407
ZQ3121	4,9 W (40 W) / 470 lm / E27 / NW	F	ZQ4E23	4,2 W (40 W) / 470 lm / E27 / NW	E	8 592920 127469

## MINI GLOBE SHAPE

Old model			New model			
Order code	Parameters	Energy class	Order code	Parameters	Energy class	EAN
ZQ1222	5 W (40 W) / 470 lm / E14 / CW	F	ZQ1E24	4,2 W (40 W) / 470 lm / E14 / CW	E	8 592920 127704
ZQ1232	7,3 W (60 W) / 806 lm / E14 / CW	E	ZQ1E44	6,5 W (60 W) / 806 lm / E14 / CW	E	8 592920 127797
ZQ1210	4,1 W (32 W) / 330 lm / E14 / WW	F	ZQ1D11	2,5 W (32 W) / 350 lm / E14 / WW	D	8 592920 127551
ZQ1220	5 W (40 W) / 470 lm / E14 / WW	F	ZQ1E21	4,2 W (40 W) / 470 lm / E14 / WW	E	8 592920 127612
ZQ1220	5 W (40 W) / 470 lm / E14 / WW	F	ZQ1E21.3	4,2 W (40 W) / 470 lm / E14 / WW / 3PC	E	8 592920 127643
ZQ1230	7,3 W (60 W) / 806 lm / E14 / WW	E	ZQ1E41	6,5 W (60 W) / 806 lm / E14 / WW	E	8 592920 127735
ZQ1211	4,1 W (32 W) / 350 lm / E14 / NW	F	ZQ1D13	2,5 W (32 W) / 350 lm / E14 / NW	D	8 592920 127582
ZQ1221	5 W (40 W) / 470 lm / E14 / NW	F	ZQ1E23	4,2 W (40 W) / 470 lm / E14 / NW	E	8 592920 127674
ZQ1221	5 W (40 W) / 470 lm / E14 / NW	F	ZQ1E23.3	4,2 W (40 W) / 470 lm / E14 / NW / 3PC	E	8 592920 128060
ZQ1231	7,3 W (60 W) / 806 lm / E14 / NW	E	ZQ1E43	6,5 W (60 W) / 806 lm / E14 / NW	E	8 592920 127766
ZQ1122	5 W (40 W) / 470 lm / E27 / CW	F	ZQ6E24	4,2 W (40 W) / 470 lm / E27 / CW	E	8 592920 127940
ZQ1132	7,3 W (60 W) / 806 lm / E27 / CW	E	ZQ6E44	6,5 W (60 W) / 806 lm / E27 / CW	E	8 592920 128039
ZQ1110	4,1 W (32 W) / 350 lm / E27 / WW	F	ZQ6D11	2,5 W (32 W) / 350 lm / E27 / WW	D	8 592920 127827
ZQ1120	5 W (40 W) / 470 lm / E27 / WW	F	ZQ6E21	4,2 W (40 W) / 470 lm / E27 / WW	E	8 592920 127889
ZQ1120	5 W (40 W) / 470 lm / E27 / WW	F	ZQ6E21.3	4,2 W (40 W) / 470 lm / E27 / WW / 3PC	E	8 592920 128091
ZQ1130	7,3 W (60 W) / 806 lm / E27 / WW	E	ZQ6E41	6,5 W (60 W) / 806 lm / E27 / WW	E	8 592920 127971
ZQ1111	4,1 W (30 W) / 350 lm / E27 / NW	F	ZQ6D13	2,5 W (32 W) / 350 lm / E27 / NW	D	8 592920 127858
ZQ1121	5 W (40 W) / 470 lm / E27 / NW	F	ZQ6E23	4,2 W (40 W) / 470 lm / E27 / NW	E	8 592920 127919
ZQ1121	5 W (40 W) / 470 lm / E27 / NW	F	ZQ6E23.3	4,2 W (40 W) / 470 lm / E27 / NW / 3PC	E	8 592920 128121
ZQ1131	7,3 W (60 W) / 806 lm / E27 / NW	E	ZQ6E43	6,5 W (60 W) / 806 lm / E27 / NW	E	8 592920 128008

## REFLECTOR SHAPE

Old model			New model			
Order code	Parameters	Energy class	Order code	Parameters	Energy class	EAN
ZQ7220	4 W (39 W) / 450 lm / E14 / WW	E	ZQ7E21	4,2 W (40 W) / 470 lm / E14 / WW	E	8 592920 128152
ZQ7221	4 W (39 W) / 450 lm / E14 / NW	E	ZQ7E23	4,2 W (40 W) / 470 lm / E14 / NW	E	8 592920 128183
ZQ7140	8,8 W (60 W) / 806 lm / E27 / WW	F	ZQ7E41	7 W (60 W) / 806 lm / E27 / WW	E	8 592920 128213
ZQ7141	8,8 W (60 W) / 806 lm / E27 / NW	F	ZQ7E43	7 W (60 W) / 806 lm / E27 / NW	E	8 592920 128244

## GU10 SHAPE

Old model			New model			
Order code	Parameters	Energy class	Order code	Parameters	Energy class	EAN
-	-	-	ZQ8338	3 W (40 W) / 535lm / NW / A CLASS	A	8 592920 129470
ZL4780	7 W (70 W) / 580 lm / NW	F	ZQ8E33N	5,8 W (75 W) / 565 lm / NW	E	8 592920 128602
ZQ8342	3,8 W (30 W) / 320 lm / CW	G	ZQ8E14	3 W (32 W) / 345 lm / CW	E	8 592920 128336
ZQ8335	4,2 W (35 W) / 333 lm / CW	F	ZQ8E19	3 W (32 W) / 345 lm / CW	E	8 592920 128572
ZQ8372	8,4 W (60 W) / 806 lm / CW	F	ZQ8E44	7 W (60 W) / 806 lm / CW	E	8 592920 128480
ZQ8340	3,8 W (30 W) / 320 lm / WW	G	ZQ8E12	3 W (32 W) / 345 lm / WW	E	8 592920 128275
ZQ8340.3	3,8 W (30 W) / 320 lm / WW / 3PC	G	ZQ8E12.3	3 W (32 W) / 345 lm / WW / 3PC	E	8 592920 128633
ZQ8350	5,7 W (40 W) / 465 lm / WW	G	ZQ8E22	4 W (39 W) / 450 lm / WW	E	8 592920 128367
ZQ8333	4,2 W (35 W) / 333 lm / WW	F	ZQ8E17	3 W (32 W) / 345 lm / WW	E	8 592920 128510
ZQ8370	8,4 W (60 W) / 806 lm / WW	F	ZQ8E42	7 W (60 W) / 806 lm / WW	E	8 592920 128428
ZQ8370.3	8,4 W (60 W) / 806 lm / WW / 3PC	F	ZQ8E42.3	7 W (60 W) / 806 lm / WW / 3PC	E	8 592920 128664
ZQ8341	3,8 W (30 W) / 320 lm / NW	G	ZQ8E13	3 W (32 W) / 345 lm / NW	E	8 592920 128305
ZQ8351	5,7 W (40 W) / 465 lm / NW	G	ZQ8E23	4 W (39 W) / 450 lm / NW	E	8 592920 128398
ZQ8334	4,2 W (35 W) / 333 lm / NW	F	ZQ8E18	3 W (32 W) / 345 lm / NW	E	8 592920 128541
ZQ8371	8,4 W (60 W) / 806 lm / NW	F	ZQ8E43	7 W (60 W) / 806 lm / NW	E	8 592920 128459
ZQ8371.3	8,4 W (60 W) / 806 lm / NW / 3PC	F	ZQ8E43.3	7 W (60 W) / 806 lm / NW / 3PC	E	8 592920 128695
-	-	-	ZQ8155D	DIM / 7 W (60 W) / 800 lm / GU10 / WW	E	8 592920 125144
-	-	-	ZQ8255D	DIM / 7 W (60 W) / 800 lm / NW	E	8 592920 125175
ZL4301	3×DIM / 6,1 W (45 W) / 560 lm / WW	F	ZQ8155S	3×DIM / 7 W (60 W) / 800 lm / WW	E	8 592920 125205
-	-	-	ZQ8255S	3×DIM / 7 W (60 W) / 800 lm / NW	E	8 592920 125236

## G9 SHAPE

Old model			New model			
Order code	Parameters	Energy class	Order code	Parameters	Energy class	EAN
-	-	-	ZQ9125D	DIM / 4,2 W (40 W) / 470 lm / WW	E	8 592920 125328
-	-	-	ZQ9225D	DIM / 4,2 W (40 W) / 470 lm / NW	E	8 592920 125359



## A60 SHAPE

Old model			New model			
Order code	Parameters	Energy class	Order code	Parameters	Energy class	EAN
-	-	-	ZF5147	3,8 W (60 W) / 806 lm / E27 / WW	A	8 592920 120569
-	-	-	ZF5147.3	3,8 W (60 W) / 806 lm / E27 / WW / 3 PC	A	8 592920 120590
-	-	-	ZF5148	3,8 W (60 W) / 806 lm / E27 / NW	A	8 592920 120620
-	-	-	ZF5148.3	3,8 W (60 W) / 806 lm / E27 / NW / 3 PC	A	8 592920 120651
-	-	-	ZF5157	5 W (75 W) / 1 060 lm / E27 / WW	A	8 592920 120682
-	-	-	ZF5157.3	5 W (75 W) / 1 060 lm / E27 / WW / 3 PC	A	8 592920 120712
-	-	-	ZF5158	5 W (75 W) / 1 060 lm / E27 / NW	A	8 592920 120743
-	-	-	ZF5158.3	5 W (75 W) / 1 060 lm / E27 / NW / 3 PC	A	8 592920 120774
-	-	-	ZF5167	7,2 W (100 W) / 1 521 lm / E27 / WW	A	8 592920 126103
-	-	-	ZF5168	7,2 W (100 W) / 1 521 lm / E27 / NW	A	8 592920 126134
Z74284	11 W (100 W) / 1 521 lm / E27 / WW	D	ZF5D62	10,5 W (100 W) / 1 521 lm / E27 / WW	D	8 592920 129890
ZF5120	3,4 W (40 W) / 470 lm / E27 / WW	D	ZF5D22	3,4 W (40 W) / 470 lm / E27 / WW	D	8 592920 129715
ZF5140	5,9 W (60 W) / 806 lm / E27 / WW	D	ZF5D42	5,9 W (60 W) / 806 lm / E27 / WW	D	8 592920 129777
ZF5140.2	5,9 W (60 W) / 806 lm / E27 / WW / 2 PC	D	ZF5D42.2	5,9 W (60 W) / 806 lm / E27 / WW / 2 PC	D	8 592920 130049
ZF5150	7,8 W (75 W) / 1 060 lm / E27 / WW	D	ZF5D52	7,8 W (75 W) / 1 060 lm / E27 / WW	D	8 592920 129838
Z74285	11 W (100 W) / 1 521 lm / E27 / NW	D	ZF5D63	10,5 W (100 W) / 1 521 lm / E27 / NW	D	8 592920 129920
ZF5121	3,4 W (40 W) / 470 lm / E27 / NW	D	ZF5D23	3,4 W (40 W) / 470 lm / E27 / NW	D	8 592920 129746
ZF5141	5,9 W (60 W) / 806 lm / E27 / NW	D	ZF5D43	5,9 W (60 W) / 806 lm / E27 / NW	D	8 592920 129807
ZF5151	7,8 W (75 W) / 1 060 lm / E27 / NW	D	ZF5D53	7,8 W (75 W) / 1 060 lm / E27 / NW	D	8 592920 129869
Z74270D	DIM / 8,5 W (75 W) / 1055 lm / WW	E	ZF5154D	DIM / 7,5 W (75 W) / 1 055 lm / E27 / WW	D	8 592920 12059
-	-	-	ZF5254D	DIM / 7,5 W (75 W) / 1 055 lm / E27 / NW	D	8 592920 125298
-	-	-	ZF5164D	DIM / 11 W (100 W) / 1 521 / lm / E27 / WW	D	8 592920 125083
-	-	-	ZF5264D	DIM / 11 W (100 W) / 1 521 / lm / E27 / NW	D	8 592920 125113

## CANDLE SHAPE

Old model			New model			
Order code	Parameters	Energy class	Order code	Parameters	Energy class	EAN
ZF3200	1,8 W (25 W) / 250 lm / E14 / WW	D	ZF3D02	1,8 W (25 W) / 250 lm / E14 / WW	D	8 592920 130018
ZF3220	3,4 W (40 W) / 470 lm / E14 / WW	D	ZF3D22	3,4 W (40 W) / 470 lm / E14 / WW	D	8 592920 130100
ZF3240	6 W (60 W) / 810 lm / E14 / WW	D	ZF3D42	5,9 W (60 W) / 806 lm / E14 / WW	D	8 592920 130162
ZF3201	1,8 W (25 W) / 250 lm / E14 / NW	D	ZF3D03	1,8 W (25 W) / 250 lm / E14 / NW	D	8 592920 130070
ZF3221	3,4 W (40 W) / 470 lm / E14 / NW	D	ZF3D23	3,4 W (40 W) / 470 lm / E14 / NW	D	8 592920 130131
ZF3241	6 W (60 W) / 810 lm / E14 / NW	D	ZF3D43	5,9 W (60 W) / 806 lm / E14 / NW	D	8 592920 130193

## A70 SHAPE

Old model			New model			
Order code	Parameters	Energy class	Order code	Parameters	Energy class	EAN
Z74290	17 W (150 W) / 2 452 lm / E27 / WW	D	ZF5D82	18 W (150 W) / 2 452 lm / E27 / WW	D	8 592920 129951
Z74291	17 W (150 W) / 2 452 lm / E27 / NW	D	ZF5D83	18 W (150 W) / 2 452 lm / E27 / NW	D	8 592920 129982

## MINI GLOBE SHAPE

Old model			New model			
Order code	Parameters	Energy class	Order code	Parameters	Energy class	EAN
ZF1240	6 W (60 W) / 810 lm / E14 / WW	D	ZF1D42	5,9 W (60 W) / 806 lm / E14 / WW	D	8 592920 130346
ZF1221	3,4 W (40 W) / 470 lm / E14 / NW	D	ZF1D23	3,4 W (40 W) / 470 lm / E14 / NW	D	8 592920 130315
ZF1241	6 W (60 W) / 810 lm / E14 / NW	D	ZF1D43	5,9 W (60 W) / 806 lm / E14 / NW	D	8 592920 130377
ZF1100	1,8 W (25 W) / 250 lm / E27 / WW	D	ZF6D02	1,8 W (25 W) / 250 lm / E27 / WW	D	8 592920 130407
ZF1200	1,8 W (25 W) / 250 lm / E14 / WW	D	ZF1D02	1,8 W (25 W) / 250 lm / E14 / WW	D	8 592920 130223
ZF1220	3,4 W (40 W) / 470 lm / E14 / WW	D	ZF1D22	3,4 W (40 W) / 470 lm / E14 / WW	D	8 592920 130285
ZF1201	1,8 W (25 W) / 250 lm / E14 / NW	D	ZF1D03	1,8 W (25 W) / 250 lm / E14 / NW	D	8 592920 130254
ZF1120	3,4 W (40 W) / 470 lm / E27 / WW	D	ZF6D22	3,4 W (40 W) / 470 lm / E27 / WW	D	8 592920 130469
ZF1140	6 W (60 W) / 810 lm / E27 / WW	D	ZF6D42	5,9 W (60 W) / 806 lm / E27 / WW	D	8 592920 130520
ZF1101	1,8 W (25 W) / 250 lm / E27 / NW	D	ZF6D03	1,8 W (25 W) / 250 lm / E27 / NW	D	8 592920 130438
ZF1121	3,4 W (40 W) / 470 lm / E27 / NW	D	ZF6D23	3,4 W (40 W) / 470 lm / E27 / NW	D	8 592920 130490
ZF1141	6 W (60 W) / 810 lm / E27 / NW	D	ZF6D43	5,9 W (60 W) / 806 lm / E27 / NW	D	8 592920 130551

## GLOBE SHAPE

Old model			New model			
Order code	Parameters	Energy class	Order code	Parameters	Energy class	EAN
ZF2150	7,8 W (75 W) / 1055 lm / E27 / WW	D	ZF2D52	7,8 W (75 W) / 1055 lm / E27 / WW	D	8 592920 130582
ZF2151	7,8 W (75 W) / 1055 lm / E27 / NW	D	ZF2D53	7,8 W (75 W) / 1055 lm / E27 / NW	D	8 592920 130605
ZF2160	11 W (100 W) / 1 521 lm / E27 / WW	D	ZF2D62	11 W (100 W) / 1 521 lm / E27 / WW	D	8 592920 130629
ZF2180	18 W (150 W) / 2 452 lm / E27 / WW	D	ZF2D82	18 W (150 W) / 2 452 lm / E27 / WW	D	8 592920 130667
ZF2161	11 W (100 W) / 1 521 lm / E27 / NW	D	ZF2D63	11 W (100 W) / 1 521 lm / E27 / NW	D	8 592920 130643
ZF2181	18 W (150 W) / 2 452 lm / E27 / NW	D	ZF2D83	18 W (150 W) / 2 452 lm / E27 / NW	D	8 592920 130681

## HIGH POWER SHAPE

Old model			New model			
Order code	Parameters	Energy class	Order code	Parameters	Energy class	EAN
ZL5751	LED / CLS / T140 / 44,5 W (270 W) / 4 850 lm / E27 / NW	F	ZF5751	LED / FLM / ED90 / 36 W (327 W) / 6 000 lm / E27 / NW	C	8 592920 131732
ZL5754	LED / CLS / T140 / 44,5 W (270 W) / 4 850 lm / E40 / NW	F	ZF5754	LED / FLM / ED90 / 36 W (327 W) / 6 000 lm / E40 / NW	C	8 592920 131718

## A60 SHAPE

Old model			New model			
Order code	Parameters	Energy class	Order code	Parameters	Energy class	EAN
ZL4010	8,5 W (60 W) / 806 lm / E27 / WW	F	ZL5F42	8,5 W (60 W) / 806 lm / E27 / WW	F	8 592920 134054
-	-	-	ZL5F42.3	8,5 W (60 W) / 806 lm / E27 / WW / 3 PC	F	8 592920 134238
-	-	-	ZL5F42.6	8,5 W (60 W) / 806 lm / E27 / WW / 6 PC	F	8 592920 134290
ZL4013	11 W (75 W) / 1 055 lm / E27 / WW	F	ZL5E52	9,5 W (75 W) / 1 055 lm / E27 / WW	E	8 592920 134115
ZL4018	15,3 W (100 W) / 1 521 lm / E27 / WW	F	ZL5E62	13 W (100 W) / 1 521 lm / E27 / WW	E	8 592920 134177
ZL4011	8,5 W (60 W) / 806 lm / E27 / NW	F	ZL5F43	8,5 W (60 W) / 806 lm / E27 / NW	F	8 592920 134085
-	-	-	ZL5F43.3	8,5 W (60 W) / 806 lm / E27 / NW / 3 PC	F	8 592920 134269
-	-	-	ZL5F43.6	8,5 W (60 W) / 806 lm / E27 / NW / 6 PC	F	8 592920 134313
ZL4014	11 W (75 W) / 1 055 lm / E27 / NW	F	ZL5E53	9,5 W (75 W) / 1 055 lm / E27 / NW	E	8 592920 134146
ZL4019	15,3 W (100 W) / 1 521 lm / E27 / NW	F	ZL5E63	13 W (100 W) / 1 521 lm / E27 / NW	E	8 592920 134207

## CANDLE SHAPE

Old model			New model			
Order code	Parameters	Energy class	Order code	Parameters	Energy class	EAN
ZL4102	6 W (42 W) / 500 lm / E14 / WW	F	ZL3F22	4,8 W (40 W) / 470 lm / E14 / WW	F	8 592920 134337
ZL4108	6 W (42 W) / 510 lm / E27 / WW	F	ZL4F22	4,8 W (40 W) / 470 lm / E27 / WW	F	8 592920 134368
ZL4116	8,3 W (66 W) / 900 lm / E14 / WW	F	ZL3F42	8,5 W (60 W) / 806 lm / E14 / WW	F	8 592920 134399
ZL4117	8,3 W (66 W) / 900 lm / E14 / NW	F	ZL3F43	8,5 W (60 W) / 806 lm / E14 / NW	F	8 592920 134429
-	-	-	ZL3F23	4,8 W (40 W) / 470 lm / E14 / NW	F	8 592920 134788

## MINI GLOBE SHAPE







Old model			New model			
Order code	Parameters	Energy class	Order code	Parameters	Energy class	EAN
ZL3904	9,4 W (60 W) / 806 lm / E14 / WW	F	ZL1F22	4,8 W (40 W) / 470 lm / E14 / WW	F	8 592920 134450
ZL3907	9,4 W (60 W) / 806 lm / E14 / WW	F	ZL6F22	4,8 W (40 W) / 470 lm / E27 / WW	F	8 592920 134481
ZL3911	9,4 W (60 W) / 806 lm / E14 / WW	F	ZL1F42	8,5 W (60 W) / 806 lm / E14 / WW	F	8 592920 134511
ZL3912	8,3 W (66 W) / 900 lm / E14 / NW	F	ZL1F43	8,5 W (60 W) / 806 lm / E14 / NW	F	8 592920 134542
-	-	-	ZL1F23	4,8 W (40 W) / 470 lm / E14 / NW	F	8 592920 134726
-	-	-	ZL6F23	4,8 W (40 W) / 470 lm / E27 / NW	F	8 592920 134757

## GU10 SHAPE







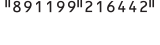

Old model			New model			
Order code	Parameters	Energy class	Order code	Parameters	Energy class	EAN
Z75060	3,3 W (21 W) / 205 lm / GU10 / NW	F	ZL8F03	2,9 W (25 W) / 250 lm / GU10 / NW	F	8 592920 134603
Z75040	3,3 W (21 W) / 200 lm / GU10 / WW	F	ZL8F02	2,9 W (25 W) / 250 lm / GU10 / WW	F	8 592920 134573
Z75130	5,8 W (40 W) / 470 lm / GU10 / WW	F	ZL8F22	5,5 W (42 W) / 500 lm / GU10 / WW	F	8 592920 134634
Z75140	5,8 W (42 W) / 500 lm / GU10 / NW	F	ZL8F23	5,5 W (42 W) / 500 lm / GU10 / NW	F	8 592920 134665

Old model			New model			
Order code	Parameters	Energy class	Order code	Parameters	Energy class	EAN
Z74300	CANDLE / 2,1 W (20 W) / 190 lm / E14 / WW+	F	Z53012	CANDLE / 2,5 W (20 W) / 225 lm / E14 / WW+	F	8 592920 133828
Z74301	A60 / 4,3 W (35 W) / 400 lm / E27 / WW+	E	Z55032	A60 / 4,5 W (35 W) / 420 lm / E27 / WW+	F	8 592920 133927
Z74302	ST64 / 4 W (40 W) / 470 lm / E27 / WW+	F	Z57032	ST64 / 4,5 W (40 W) / 420 lm / E27 / WW+	F	8 592920 133859
Z74303	G125 / 4 W (40 W) / 470 lm / E27 / WW+	E	Z58032	G125 / 4,5 W (40 W) / 420 lm / E27 / WW+	F	8 592920 133880
Z74304	G95 / 4 W (40 W) / 470 lm / E27 / WW+	E	Z52032	G95 / 4,5 W (40 W) / 420 lm / E27 / WW+	F	8 592920 133903

## Ultra Plus





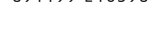



Old model		New model			
Order code	Battery type	Order code	Parameters	Battery type	EAN
B17112	AAA	B03112	voltage: 1.5 V; price for quantity: price per 1 pc; packaging: 2 pcs, small paper box	AAA	 4 891199 218163
B1711	AAA	B03114	voltage: 1.5 V; price for quantity: price per 1 pc; packaging: 4 pcs, small paper box	AAA	 4 891199 203985
B17212	AA	B03212	voltage: 1.5 V; price for quantity: price per 1 pc; packaging: 2 pcs, small paper box	AA	 4 891199 216633
B1721	AA	B03214	voltage: 1.5 V; price for quantity: price per 1 pc; packaging: 4 pcs, small paper box	AA	 4 891199 203923
B1731	C	B03312	voltage: 1.5 V; price for quantity: price per 1 pc; packaging: 2 pcs, small paper box	C	 4 891199 217654
B1741	D	B03412	voltage: 1.5 V; price for quantity: price per 1 pc; packaging: 2 pcs, small paper box	D	 4 891199 220159
B1751	9 V	B03511	voltage: 9 V; price for quantity: price per 1 pc; packaging: 1 pc, small paper box	9 V	 4 891199 216442

## Ultra





Old model		New model			
Order code	Battery type	Order code	Parameters	Battery type	EAN
B1911MM	AAA	B0211V	voltage: 1.5 V; price for quantity: price per 1 pc; packaging: 6 pcs, small paper box	AAA	 4 891199 218347
B19118	AAA	B02118	voltage: 1.5 V; price for quantity: price per 1 pc; packaging: 8 pcs, small paper box	AAA	 4 891199 219603
B1911	AAA	B02114	voltage: 1.5 V; price for quantity: price per 1 pc; packaging: 4 pcs, small paper box	AAA	 4 891199 218255
B1921	AA	B02214	voltage: 1.5 V; price for quantity: price per 1 pc; packaging: 4 pcs, small paper box	AA	 4 891199 217357
B1921MM	AA	B0221V	voltage: 1.5 V; price for quantity: price per 1 pc; packaging: 6 pcs, small paper box	AA	 4 891199 217388
B19218	AA	B02218	voltage: 1.5 V; price for quantity: price per 1 pc; packaging: 8 pcs, small paper box	AA	 4 891199 219665
B1931	C	B02312	voltage: 1.5 V; price for quantity: price per 1 pc; packaging: 2 pcs, small paper box	C	 4 891199 217753
B1941	D	B02412	voltage: 1.5 V; price for quantity: price per 1 pc; packaging: 2 pcs, small paper box	D	 4 891199 220166
B1951	9 V	B02511	voltage: 9 V; price for quantity: price per 1 pc; packaging: 1 pc, small paper box	9 V	 4 891199 216398

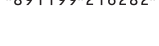

















## Super

Old model		New model			
Order code	Battery type	Order code	Parameters	Battery type	EAN
B1310	AAA	B01102	voltage: 1.5 V; price for quantity: price per 1 pc; packaging: 2 pcs, shrink	AAA	
B1311	AAA	B01114	voltage: 1.5 V; price for quantity: price per 1 pc; packaging: 4 pcs, small paper box	AAA	
B13118	AAA	B01118	voltage: 1.5 V; price for quantity: price per 1 pc; packaging: 8 pcs, small paper box	AAA	
B1310G	AAA	B0111G	voltage: 1.5 V; price for quantity: price per 1 pc; packaging: 10 pc, small paper box	AAA	
B1310L	AAA	B0110L	voltage: 1.5 V; price for quantity: price per 1 pc; packaging: 20 pcs, shrink	AAA	
B1310T2	AAA	B0114T	voltage: 1.5 V; price for quantity: price per 1 pc; packaging: 288 pcs, display box	AAA	
B1320	AA	B01202	voltage: 1.5 V; price for quantity: price per 1 pc; packaging: 2 pcs, shrink	AA	
B1321	AA	B01214	voltage: 1.5 V; price for quantity: price per 1 pc; packaging: 4 pcs, small paper box	AA	
B13218	AA	B01218	voltage: 1.5 V; price for quantity: price per 1 pc; packaging: 8 pcs, small paper box	AA	
B1320G	AA	B0121G	voltage: 1.5 V; price for quantity: price per 1 pc; packaging: 10 pc, small paper box	AA	
B1320L	AA	B0120L	voltage: 1.5 V; price for quantity: price per 1 pc; packaging: 20 pcs, shrink	AA	
B1320T2	AA	B0124T	voltage: 1.5 V; price for quantity: price per 1 pc; packaging: 288 pcs, display box	AA	
B1331	C	B01312	voltage: 1.5 V; price for quantity: price per 1 pc; packaging: 2 pcs, small paper box	C	
B1330	C	B01302	voltage: 1.5 V; price for quantity: price per 1 pc; packaging: 2 pcs, shrink	C	
B13304	C	B01304	voltage: 1.5 V; price for quantity: price per 1 pc; packaging: 4 pcs, shrink	C	
B1341	D	B01412	voltage: 1.5 V; price for quantity: price per 1 pc; packaging: 2 pcs, small paper box	D	
B1340	D	B01402	voltage: 1.5 V; price for quantity: price per 1 pc; packaging: 2 pcs, shrink	D	
B13404	D	B01404	voltage: 1.5 V; price for quantity: price per 1 pc; packaging: 4 pcs, shrink	D	
B1351	9 V	B01511	voltage: 9 V; price for quantity: price per 1 pc; packaging: 1 pc, small paper box	9 V	
B1350	9 V	B01501	voltage: 9 V; price for quantity: price per 1 pc; packaging: 1 pc, shrink	9 V	

## Recyko Pro

Old model		New model			
Order code	Battery type	Order code	Parameters	Battery type	EAN
B22184	AAA	B26184	voltage: 1.2 V; capacity: 800 mAh; number of charging cycles: more than 1 500; price for quantity: price per 1 pc; packaging: 4 pcs, small paper box	AAA	
B2218V	AAA	B2618V	voltage: 1.2 V; capacity: 800 mAh; number of charging cycles: more than 1 500; price for quantity: price per 1 pc; packaging: 6 pcs, small paper box	AAA	
B22204	AA	B26204	voltage: 1.2 V; capacity: 2 000 mAh; number of charging cycles: more than 1 500; price for quantity: price per 1 pc; packaging: 4 pcs, small paper box	AA	
B2220V	AA	B2620V	voltage: 1.2 V; capacity: 2 000 mAh; number of charging cycles: more than 1 500; price for quantity: price per 1 pc; packaging: 6 pcs, small paper box	AA	
B2420	AA	B2629	voltage: 1.2 V; capacity: 2 000 mAh; number of charging cycles: more than 500; price for quantity: price per 1 pc; packaging: 4 pcs, small paper box	AA	

## Recyko

Old model		New model			
Order code	Battery type	Order code	Parameters	Battery type	EAN
B21114	AAA	B25114	voltage: 1.2 V; capacity: 950 mAh; number of charging cycles: more than 500; price for quantity: price per 1 pc; packaging: 4 pcs, small paper box	AAA	 4 891199 212635
B2111V	AAA	B2511V	voltage: 1.2 V; capacity: 950 mAh; number of charging cycles: more than 500; price for quantity: price per 1 pc; packaging: 6 pcs, small paper box	AAA	 4 891199 222351
B2111	AAA	B25112	voltage: 1.2 V; capacity: 950 mAh; number of charging cycles: more than 500; price for quantity: price per 1 pc; packaging: 2 pcs, small paper box	AAA	 4 891199 212628
-	-	B25182	voltage: 1.2 V; capacity: 850 mAh; number of charging cycles: more than 500; price for quantity: price per 1 pc; packaging: 2 pcs, small paper box	AAA	 4 891199 212642
-	-	B25184	voltage: 1.2 V; capacity: 850 mAh; number of charging cycles: more than 500; price for quantity: price per 1 pc; packaging: 2 pcs, small paper box	AAA	 4 891199 212659
B2116	AAA	B25162	voltage: 1.2 V; capacity: 650 mAh; number of charging cycles: more than 1 000; price for quantity: price per 1 pc; packaging: 2 pcs, small paper box	AAA	 4 891199 212666
B2127	AA	B25272	voltage: 1.2 V; capacity: 2 600 mAh; number of charging cycles: more than 300; price for quantity: price per 1 pc; packaging: 2 pcs, small paper box	AA	 4 891199 212567
B21274	AA	B25274	voltage: 1.2 V; capacity: 2 600 mAh; number of charging cycles: up to 300; price for quantity: price per 1 pc; packaging: 4 pcs, small paper box	AA	 4 891199 212574
B2127V	AA	B2527V	voltage: 1.2 V; capacity: 2 600 mAh; number of charging cycles: up to 300; price for quantity: price per 1 pc; packaging: 6 pcs, small paper box	AA	 4 891199 222368
B2121	AA	B25212	voltage: 1.2 V; capacity: 2 100 mAh; number of charging cycles: more than 500; price for quantity: price per 1 pc; packaging: 2 pcs, small paper box	AA	 4 891199 212581
-	-	B25214	voltage: 1.2 V; capacity: 2 100 mAh; number of charging cycles: more than 500; price for quantity: price per 1 pc; packaging: 4 pcs, small paper box	AA	 4 891199 212598
B2121V	AA	B2521V	voltage: 1.2 V; capacity: 2 100 mAh; number of charging cycles: more than 500; price for quantity: price per 1 pc; packaging: 6 pcs, small paper box	AA	 4 891199 222375
B2123	AA	B25232	voltage: 1.2 V; capacity: 1 300 mAh; number of charging cycles: more than 500; price for quantity: price per 1 pc; packaging: 2 pcs, small paper box	AA	 4 891199 212604
B2133	C	B2533	voltage: 1.2 V; capacity: 3 000 mAh; number of charging cycles: more than 1 000; price for quantity: price per 1 pc; packaging: 2 pcs, small paper box	C	 4 891199 212697
B2145	D	B2543	voltage: 1.2 V; capacity: 3 000 mAh; number of charging cycles: more than 1 000; price for quantity: price per 1 pc; packaging: 2 pcs, small paper box	D	 4 891199 212703
B2152	9 V	B2552	voltage: 8.4 V; capacity: 200 mAh; number of charging cycles: more than 500; price for quantity: price per 1 pc; packaging: 1 pc, small paper box	9 V	 4 891199 212710



### Children's safety plugs

This icon in the catalogue refers to the presence of children's safety plugs in outlets of extension cords or surge protections.



### E-shop for Business Partners

We have an e-shop for business partners at <https://en.b2b.emos.cz>.  
Take advantage of the benefits of online purchasing of our products anywhere you need.



### Manuals for Goods

<https://www.emos.eu/download>

Here you can find all manuals for goods we have available, even for items no longer on offer.  
Manuals can also be downloaded from the product details.

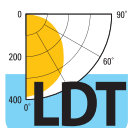

### Photometric data

<https://www.emos.eu/download>

Here you can find photometric data for processing lighting projects using software tools such as DIALUX or RELUX.



A/ B/ C/ D

### Packaging

A – retail packaging  
B – number of products in a group packaging  
C – number of products per inner carton  
D – number of products per export carton







## Making Life Easy

EMOS spol. s r.o.  
Lipnická 2844  
750 02 Prerov  
Czech Republic

e-mail: [emos@emos.cz](mailto:emos@emos.cz)  
phone: +420 581 261 111

[www.emos.eu/en](http://www.emos.eu/en)

Y11099

