

SENZORY PIR

Venkovní i vnitřní detektory pohybu, které fungují jako spínače pro světla, venkovní reflektory či alarmy. Detektory reagují na pohyb osob, zvířat nebo dalších objektů na základě jejich vyzařovaného nebo odraženého infračerveného záření (tzv. PIR senzory).

Hlavní benefity:

- různá provedení a design
- detekční úhel 180° nebo 360°
- modely pro přisazenou i vestavnou montáž

Oblasti použití: v domácnosti i průmyslových prostorách.

Materiál těla	plast (PC)
IP	IP44, IP65

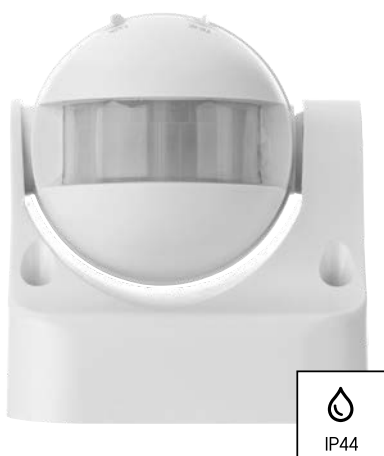
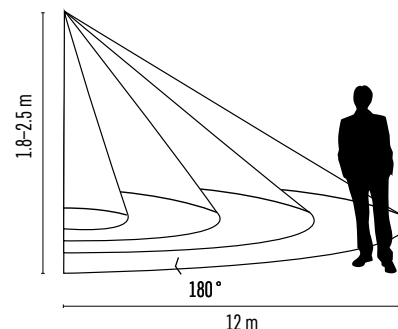

G1120

1/-/-/40

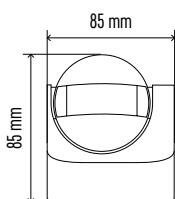

75 mm

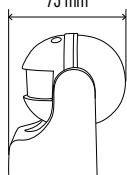

G1125

1/-/-/40

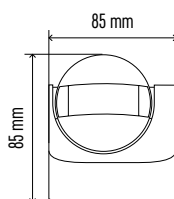

75 mm

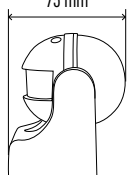

G1240

1/-/-/40

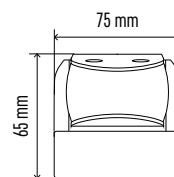

65 mm

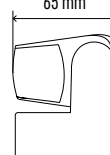

Typ	EAN	Detekční úhel	Detekční dosah	Typ senzoru	Krytí	Doba sepnutí	Š × V × H
G1120	8592920032817	180°	12 m	PIR	IP44	min. 10 sekund – max. 7 minut	85 × 75 × 85 mm
G1125	8592920032831	180°	12 m	PIR	IP44	min. 10 sekund – max. 7 minut	85 × 75 × 85 mm
G1240	8592920085882	180°	12 m	PIR	IP65	min. 10 sekund – max. 15 minut	75 × 65 × 65 mm

Materiál těla	plast (PC)
IP	IP20

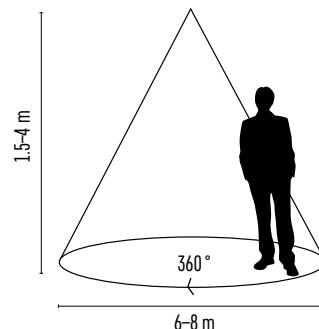

G1150

1/-/-/20

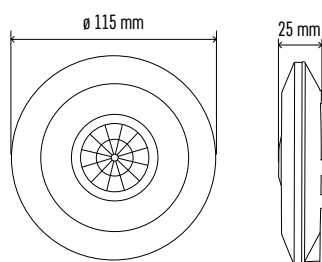

G1130

1/-/-/20

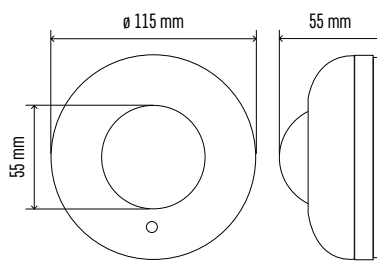

G1160

1/-/-/36



Typ	EAN	Detekční úhel	Detekční dosah	Typ senzoru	Krytí	Doba sepnutí	Průměr × H
G1150	8592920025147	360°	6 m	PIR	IP20	min. 10 sekund – max. 15 minut	ø 115 × 25 mm
G1130	8592920025123	360°	6 m	PIR	IP20	min. 10 sekund – max. 7 minut	ø 115 × 55 mm
G1160	8592920025154	360°	6 m	PIR	IP20	min. 10 sekund – max. 15 minut	ø 70 × 75 mm

LED DRIVERS

Náhradní externí zdroje umožňující stmívání a ovládání. Zajišťují optimální funkci, trvanlivost a energetickou účinnost.

ZR9080

1/-/-/36



ZZ409BD

1/-/-/48



ZZ1435T

1/-/-/100



ZZ2055T

1/-/-/100



ZZ3070T

1/-/-/100



Typ	EAN	Příkon	Proud na výstupu	Napětí na výstupu	Typ	PF	Š × V × H
ZR9080	8592920068748	16–40 W	350–1 050 mA	30–57 V DC	MULTI	> 0,9	124,5 × 82,5 × 25,4 mm
ZZ409BD	8592920107102	40 W	450–1 100 mA	6–42 V DC	DALI 2.0	> 0,9	103 × 68 × 30 mm
ZZ1435T	8592920114322	14 W	250–350 mA	25–40 V DC	TRIAK	> 0,9	97 × 46 × 31 mm
ZZ2055T	8592920114339	20 W	400–550 mA	25–40 V DC	TRIAK	> 0,9	117 × 46 × 31 mm
ZZ3070T	8592920114346	28 W	550–700 mA	25–40 V DC	TRIAK	> 0,9	117 × 46 × 31 mm